

1
Ag84Te
c.4

Σ



United States
Department of
Agriculture

Agricultural
Research
Service

Technical
Bulletin
Number 1768

EPIC—Erosion/Productivity Impact Calculator

1. Model Documentation

UNITED STATES DEPARTMENT OF AGRICULTURE
NATIONAL BRANCH

DEC 3 1980

USDA
NATIONAL BRANCH
WASHINGTON, D.C.

5

ABSTRACT

Sharpley, A.N., and J.R. Williams, eds. 1990. EPIC--Erosion/Productivity Impact Calculator: 1. Model Documentation. U.S. Department of Agriculture Technical Bulletin No. 1768. 235 pp.

This publication describes the EPIC model, which predicts the impact of erosion on soil productivity. The model simulates erosion, plant growth, and related processes; it also makes economic assessments, such as cost of erosion. A sensitivity analysis of input parameters is presented, and EPIC is evaluated by comparison of EPIC-predicted and observed data.

KEYWORDS: agricultural management, crop yield, economics, hydrology, prediction, sensitivity, simulation, soil cultivation, soil fertility, soil nutrients, wind erosion.

While they last, single copies of this publication may be obtained from USDA-ARS, Water Quality and Watershed Research Laboratory, P.O. Box 1430, Durant, OK 74702-1430 and USDA-ARS, Grassland, Soil and Water Research Laboratory, 808 East Blackland Road, Temple, TX 76502.

Copies of this publication may also be purchased from the National Technical Information Service, 5285 Port Royal Road, Springfield, VA 22161.

Mention of trade names or commercial products is solely for the purpose of providing specific information and does not imply recommendation or endorsement by the U.S. Department of Agriculture.

ACKNOWLEDGMENTS

The assistance of Elaine Mead and Janice A. Story, U. S. Dep. Agric., Durant, OK and Janice Brown, U. S. Dep. Agric., Temple, TX in typing this publication is gratefully acknowledged.

USDA, National Agricultural Library
NAL Bldg
10301 Baltimore Blvd
Beltsville, MD 20705-2351

Issued September 1990

CONTRIBUTORS

USDA, National Agricultural Library
NAL Bldg
10301 Baltimore Blvd
Beltsville, MD 20705-2351

G.W. Cole
Agricultural Engineer
USDA-ARS
Wind Erosion Research Unit
Kansas State University
Room 105B, East Waters Hall
Manhattan, KS 66506

O.R. Jones
Soil Scientist
USDA-ARS
Conservation and Production Research
Laboratory
P.O. Drawer 10
Bushland, TX 79012

K.R. Cooley
Hydrologist
USDA-ARS
Northwest Watershed Research Center
270 South Orchard
Boise, ID 83705

J.R. Kiniry
Research Agronomist
USDA-ARS
Grassland, Soil and Water Research
Laboratory
808 East Blackland Road
Temple, TX 76502

P.T. Dyke
Research Scientist
Texas Agricultural Experiment Station
Blackland Research Center
808 East Blackland Road
Temple, TX 76502

J.M. Laflen
Agricultural Engineer
USDA-ARS
National Soil Erosion Research
Laboratory
Purdue University, SOIL Bg.
West Lafayette, IN 47907

D.T. Favis-Mortlock
Research Scientist
Countryside Research Unit
Brighton Polytechnic
Falmer, Brighton, BN1 9PH
England

Leon Lyles, Retired
Agricultural Engineer
USDA-ARS
Wind Erosion Research Unit
Room 105, East Waters Hall
Kansas State University
Manhattan, KS 66506

G.R. Foster
Head, Department of Agricultural
Engineering
213 Agricultural Engineering Building
University of Minnesota
St. Paul, MN 55108

A.D. Nicks
Agricultural Engineer
USDA-ARS
Water Quality and Watershed
Research Laboratory
P.O. Box 1430
Durant, OK 74702-1430

C.L. Hanson
Agricultural Engineer
USDA-ARS
Northwest Watershed Research Center
270 South Orchard
Boise, ID 83705

C.A. Onstad
Agricultural Engineer
USDA-ARS
North Central Soil Conservation
Research Laboratory
North Iowa Avenue
Morris, MN 56267

C.A. Jones
Resident Director
Texas Agricultural Experiment Station
Blackland Research Center
808 East Blackland Road
Temple, TX 76502

USDA, National Agricultural Library
NAL Bldg
10301 Baltimore Blvd
Beltsville, MD 20705-2351

C.W. Richardson
Agricultural Engineer
USDA-ARS
Grassland, Soil and Water Research
Laboratory
808 East Blackland Road
Temple, TX 76502

E.P. Springer
Hydrologist
USDA-ARS
Northwest Watershed Research
Center
270 South Orchard
Boise, ID 83705

D.C. Robertson
Hydrologic Technician
USDA-ARS
Northwest Watershed Research
Center
270 South Orchard
Boise, ID 83705

J.L. Steiner
Soil Scientist
USDA-ARS
Conservation and Production Research
Laboratory
P.O. Drawer 10
Bushland, TX 79012

A.N. Sharpley
Soil Scientist
USDA-ARS
Water Quality and Watershed
Research Laboratory
P.O. Box 1430
Durant, OK 74702-1430

J.R. Williams
Hydraulic Engineer
USDA-ARS
Grassland, Soil and Water Research
Laboratory
808 East Blackland Road
Temple, TX 76502

S.J. Smith
Soil Scientist
USDA-ARS
Water Quality and Watershed
Research Laboratory
P.O. Box 1430
Durant, OK 74702-1430

F.R. Smith
Lecturer
Countryside Research Unit
Brighton Polytechnic
Falmer, Brighton BN1 9PH
England

D.A. Spanel
Biological Technician
USDA-ARS
Grassland, Soil and Water Research
Laboratory
808 East Blackland Road
Temple, TX 76502

CONTENTS

Chapter			
1. Introduction	1	5. Computation of Universal Soil Loss Equation R and C factors for simulating individual-storm soil loss	125
Reference	2	Abstract	125
2. The EPIC Model	3	Introduction	125
Abstract	3	Modification of the USLE rainfall and runoff factor	125
Model description	3	Modification of the USLE cover and management factor (C)	127
Hydrology	4	PLU, prior-land-use subfactor	129
Weather	18	CC, crop-canopy subfactor	130
Erosion	25	SR, surface-roughness subfactor	131
Nutrients	33	RC, residue-cover subfactor	132
Soil temperature	43	Testing storm soil loss simulation	135
Crop growth model	45	Notations	136
Tillage	60	References	137
Plant environmental control	62		
Economics	68	6. The wind erosion component of EPIC	139
Summary and conclusions	70	Abstract	139
Notations	70	Introduction	139
References	86	Wind erosion	139
3. Weather generator description	93	General concepts	139
Abstract	93	Modifications	141
Introduction	93	Simulation results	146
Weather generator description	93	Notations	149
Precipitation	93	References	151
Temperature and solar radiation	94		
Wind	96	7. The nutrient component of EPIC	152
Precipitation and temperature correction	97	Abstract	152
Example application of the weather generator	98	Introduction	152
Notations	102	Nutrient model compartments	152
References	103	Organic transformations	152
4. Evaluation of the EPIC model weather generator	105	Inorganic transformations	154
Abstract	105	Fertilizer application	155
Introduction	105	Plant uptake	155
Evaluation method	106	Data requirements	156
Results	115	Model testing	161
Discussion	121	Conclusions	163
Conclusions	121	Acknowledgments	163
References	124	References	164

8. Estimation of soil pH changes in EPIC	167	12. Evaluation of EPIC nutrient projections using soil profiles for virgin and cultivated lands of the same soil series	217
Abstract	167	Abstract	217
Introduction	167	Introduction	217
Method	169	Soil management	217
Program	171	Evaluation of nutrient projections	218
Test results	172	References	219
References	173		
Appendix	174		
9. A sensitivity analysis of EPIC	178	13. Demonstration and validation of crop grain yield simulation by EPIC	220
Abstract	178	Abstract	220
Introduction	178	Introduction	220
Analytical methods	178	Values for parameters	222
Results	181	Simulating corn grain yield response to soil depth	227
Discussion	181	Simulating grain yield of six crop species	228
Guidance for EPIC users	187	Simulating corn grain yield response to irrigation	232
Notations	189	Overall conclusions	232
Acknowledgments	190	References	234
10. Evaluation of EPIC using a dryland wheat-sorghum-fallow crop rotation	191	14. Perspectives	235
Abstract	191	Reference	235
Introduction	191		
Description of the validation test	192		
Model performance and discussion	196		
Conclusions	203		
References	204		
11. Evaluation of EPIC using a sagebrush range site	206		
Abstract	206		
Introduction	206		
Study area and methods	206		
Results and discussion	209		
Conclusions	215		
References	216		

1. INTRODUCTION

A.N. Sharpley and J.R. Williams

Accurate estimates of future soil productivity are essential in agricultural decision-making and planning from the field scale to the national level. Soil erosion reduces soil productivity, but the relationship between erosion and productivity has not been well defined. Until the relationship is adequately defined, selecting management strategies to maximize long-term crop production will be impossible.

According to the Soil and Water Resources Conservation Act (RCA), a report on the status of soil and water resources in the United States was required by 1985. One important aspect of these resources is the effect of erosion on long-term soil productivity. In 1981, the National Soil-Erosion/Soil-Productivity Research Planning Committee documented what was known about the problem, identified what additional knowledge was needed, and outlined a research approach for solving the problem (Williams 1981). One of the most urgent needs outlined in the report was the development of a mathematical model for simulating erosion, crop production, and related processes. This model was envisioned to be used for determining the relationship between erosion and productivity for the United States. A national ARS erosion/productivity modeling team¹ was organized and began developing the model in 1981, setting four goals in the development process. The model was to be (a) physically based and capable of simultaneously and realistically simulating the processes involved in erosion by using readily available inputs; (b) capable of simulating the processes as they would occur over hundreds of years, if necessary, because erosion can occur relatively slowly; (c) applicable to a wide range of soils, climates, and crops encountered in the United States; and (d) efficient, convenient to use, and capable of assessing the effects of management changes on erosion and soil productivity.

The model developed, EPIC (Erosion-Productivity Impact Calculator), consists of (a) physically based components for simulating erosion, plant growth, and related processes and (b) economic components both for assessing the cost of erosion and for determining optimal management strategies. The model was developed in time to analyze the relationship between erosion and productivity for the RCA-mandated report. Beyond the analysis for the RCA report, EPIC should be a useful decision-making tool for determining optimal management

¹J.R. Williams, J.M. Shaffer, K.G. Renard, G.R. Foster, J.M. Laflen, L. Lyles, C.A. Onstad, A.N. Sharpley, A.D. Nicks, C.A. Jones, C.W. Richardson, P.T. Dyke, K.R. Cooley, and S.J. Smith.

strategies from the farm to the national level. For example, EPIC is capable of dealing with decisions involving drainage, irrigation, water yield, erosion control (wind and water), weather, fertilizer and lime applications, pest control, planting dates, tillage, and crop residue management. As a research tool, EPIC can be used in developing, testing, and refining model components for various processes; sensitivity analysis to determine the importance of experimental variables and their interactions; and designing field experiments to obtain maximum information for the minimum cost.

This publication details the EPIC model and its components and, in addition, provides information on several components and use of the model.

REFERENCE

National Soil-Erosion-Soil Productivity Research Planning Committee, USDA-ARS. 1981. Soil erosion effects on soil productivity: A research perspective. J. Soil Water Conserv. 36:82-90.

2. THE EPIC MODEL

J.R. Williams, C.A. Jones, and P.T. Dyke

ABSTRACT

EPIC (Erosion/Productivity Impact Calculator) is a comprehensive model developed to determine the relationship between soil erosion and soil productivity throughout the United States. It continuously simulates the processes associated with erosion, using a daily time step and readily available inputs. Since erosion can occur relatively slowly, the model can simulate the process over hundreds of years if necessary. EPIC is generally applicable, computationally efficient, and capable of computing the effects of management changes on outputs. EPIC is composed of (a) physically based components for simulating erosion, plant growth, and related processes and (b) economic components for assessing the cost of erosion, determining optimal management strategies, etc. The EPIC physical components include hydrology, weather simulation, erosion-sedimentation, nutrient cycling, plant growth, tillage, and soil temperature.

MODEL DESCRIPTION

EPIC is a fairly comprehensive model, developed specifically for application to the erosion/productivity problem (National Soil Erosion-Soil Productivity Research Planning Committee USDA-ARS 1981; Williams et al. 1985). Thus, computational efficiency and user convenience were important considerations in designing the model. The model can be run on a variety of mainframes and microcomputers. User convenience features are described in a separate publication. (Previous versions of EPIC have been described in limited detail by Williams 1983; Williams and Renard 1985; Williams et al. 1983a, 1983b, 1984a, 1984b.)

The drainage area considered by EPIC is generally small (≈ 1 ha) because soils and management are assumed to be spatially homogeneous. In the vertical direction, however, the model is capable of working with any variation in soil properties, the soil profile being divided into a maximum of 10 layers. When erosion occurs, the second layer thickness is reduced by the amount of the eroded thickness, and the top layer properties are adjusted by interpolation (according to the distance the first layer is moved into the second layer). When the second layer thickness becomes zero, the top layer is moved into the third layer, etc.

The EPIC model consists of numerous component models that pertain to the following major aspects of the erosion/productivity relationship: hydrology, weather, erosion, nutrients, plant growth, soil temperature, tillage, economics, and plant environment control. Descriptions of the EPIC components and the mathematic relationships used to simulate the processes involved follow.

The runoff model simulates surface runoff volumes and peak runoff rates, given daily rainfall amounts. Runoff volume is estimated by using a modification of the Soil Conservation Service (SCS) curve number technique (U.S. Department of Agriculture, Soil Conservation Service 1972). The technique was selected for use because (a) it is reliable and has been used for many years in the United States; (b) it is computationally efficient; (c) the required inputs are generally available; and (d) it relates runoff to soil type, land use, and management practices. The use of readily available daily rainfall data is a particularly important attribute of the curve number technique because for many locations, rainfall data with time increments of less than 1 day are not available. Also, rainfall data manipulations and runoff computations are more efficient for data taken daily than at shorter intervals. Peak discharge rate is estimated by using a modification of the Rational formula. A stochastic element is introduced to the Rational equation to allow realistic simulation of peak discharge rates, given only daily rainfall and monthly rainfall intensity information.

Runoff Volume

Surface runoff is predicted for daily rainfall by using the SCS curve number equation (U.S. Department of Agriculture, Soil Conservation Service 1972)

$$Q = \frac{(R - 0.2s)^2}{R + 0.8s}, \quad R > 0.2s \quad [2.1]$$

$$Q = 0.0, \quad R \leq 0.2s$$

where Q is the daily runoff, R is the daily rainfall, and s is a retention parameter (see "Notations" section). The retention parameter, s , varies (a) among watersheds because soils, land use, management, and slope all vary and (b) with time because of changes in soil water content. The parameter s is related to curve number (CN) by the SCS equation (U.S. Department of Agriculture, Soil Conservation Service 1972)

$$s = 254 \left(\frac{100}{CN} - 1 \right) \quad [2.2]$$

The constant, 254, in equation 2.2 gives s in millimeters. Thus, R and Q are also expressed in millimeters. CN_2 --the curve number for moisture condition 2, or average curve number--can be obtained easily for any area by using the SCS hydrology handbook (U.S. Department of Agriculture, Soil Conservation Service 1972). The handbook tables consider soils, land use, and

management. Assuming that the handbook CN_2 value is appropriate for a 5% slope, we developed the following equation for adjusting that value for other slopes.

$$CN_{2s} = \frac{1}{3} (CN_3 - CN_2) [1 - 2 \exp(-13.86 S)] + CN_2 \quad [2.3]$$

where CN_{2s} is the handbook CN_2 value adjusted for slope, CN_3 is the curve number for moisture condition 3 (wet), and S is the average slope of the watershed. Values of CN_1 , the curve number for moisture condition 1 (dry), and CN_3 corresponding to CN_2 are also tabulated in the handbook. For computing purposes, CN_1 and CN_3 were related to CN_2 with the equations

$$CN_1 = CN_2 - \frac{20(100 - CN_2)}{100 - CN_2 + \exp[2.533 - 0.0636(100 - CN_2)]} \quad [2.4]$$

$$CN_3 = CN_2 \exp[0.00673(100 - CN_2)] \quad [2.5]$$

Fluctuations in soil water content cause the retention parameter to change according to the equation

$$s = s_1 \left(1 - \frac{FFC}{FFC + \exp[w_1 - w_2 (FFC)]} \right) \quad [2.6]$$

where s_1 is the value of s associated with CN_1 , FFC is the fraction of field capacity, and w_1 and w_2 are shape parameters. FFC is computed with the equation

$$FFC = \frac{SW - WP}{FC - WP} \quad [2.7]$$

where SW is the soil water content in the root zone, WP is the wilting point water content (1,500 kPa for many soils) and FC is the field capacity water content (33 kPa for many soils).

Values for w_1 and w_2 are obtained from a simultaneous solution of equation 2.6 according to the assumptions that $s=s_2$ when $FFC=0.5$ and $s=s_3$ when $FFC=1.0$:

$$w_1 = \ln \left(\frac{1.0}{1.0 - \frac{s_3}{s_1}} - 1.0 \right) + w_2 \quad [2.8]$$

$$w_2 = 2.0 \left(\ln \left(\frac{0.5}{1 - \frac{s_2}{s_1}} \right) - 0.5 - \ln \left(\frac{1.0}{1 - \frac{s_3}{s_1}} - 1.0 \right) \right) \quad [2.9]$$

where s_3 is the CN_3 retention parameter. Equations 2.8 and 2.9 assure that CN_1 corresponds with the wilting point and that the curve number cannot exceed 100.

The FFC value obtained in equation 2.7 represents soil water uniformly distributed through the top 1.0 m of soil. Runoff estimates can be improved if the depth distribution of soil water is known. For example, water distributed near the soil surface results in more runoff than the same volume of water uniformly distributed throughout the top meter of soil. Also, a soil surface associated with such a uniform distribution of soil water results in more runoff than a soil surface that is dry. Since EPIC estimates water content of each soil layer daily, the depth distribution is available. The effect of depth distribution on runoff is expressed in the depth weighting function

$$FFC^* = \frac{\sum_{\ell=1}^M FFC_{\ell} \left(\frac{Z_{\ell} - Z_{\ell-1}}{Z_{\ell}} \right)}{\sum_{\ell=1}^M \frac{Z_{\ell} - Z_{\ell-1}}{Z_{\ell}}}, \quad Z_{\ell} \leq 1.0m \quad [2.10]$$

where FFC^* is the depth weighted FFC value for use in equation 2.6, Z is the depth (m) to the bottom of soil layer ℓ , and M is the number of soil layers. Equation 2.10 performs two functions: (1) it reduces the influence of lower layers because FFC_{ℓ} is divided by Z_{ℓ} and (2) it gives proper weight to thick layers relative to thin layers because FFC is multiplied by the layer thickness.

There is also a provision for estimating runoff from frozen soil. If the temperature in the second soil layer is less than $0^{\circ}C$, the retention parameter is reduced by using the equation

$$s_f = s [1 - \exp(-0.00292 s)] \quad [2.11]$$

where s_f is the retention parameter for frozen ground. Equation 2.11 increases runoff for frozen soils but allows significant infiltration when soils are dry.

The final step in estimating the runoff volume is an attempt to account for uncertainty. The retention parameter or curve number estimate is based on land use, management, hydrologic soil group, land slope, and soil water content and distribution and is adjustable for frozen soil. However, many complex natural processes and artificial diversions that affect runoff are not accounted for in the model. Thus, the final curve number estimate is generated from a triangular distribution to account for this uncertain variation. The mean of the triangle is the best estimate of curve number based on using equations 2.10, 2.7, 2.6, 2.3, 2.2, and 2.11. The extremes are ± 5 curve numbers from the mean. The generated curve number is substituted into equation 2.2 to estimate runoff with equation 2.1.

Peak Runoff Rate

Peak runoff rate predictions are based on a modification of the Rational formula

$$q_p = (\rho) (r) (A) / 360 \quad [2.12]$$

where q_p is the peak runoff rate (m^3/s), ρ is a runoff coefficient expressing the watershed infiltration characteristics, r is the rainfall intensity (mm/h) for the watershed's time of concentration, and A is the drainage area (ha). The runoff coefficient can be calculated for each storm if the amount of rainfall and runoff are known:

$$\rho = \frac{Q}{R} \quad [2.13]$$

Since R is input and Q is computed with equation 2.1, ρ can be calculated directly. Rainfall intensity can be expressed with the relationship

$$r = \frac{R_{t_c}}{t_c} \quad [2.14]$$

where R_{t_c} is the amount of rainfall (mm) during the watershed's time of concentration, t_c (h). The value of R_{t_c} can be estimated by developing a relationship with total R . The Weather Service's TP-40 (Hershfield 1961) provides accumulated rainfall amounts for various durations and frequencies. Generally, R_{t_c} and R_{24} (24-h duration is appropriate for the daily time step model) are proportional for various frequencies. Thus,

$$R_{t_c} = aR_{24} \quad [2.15]$$

where a is a dimensionless parameter that expresses the proportion of total rainfall that occurs during t_c .

The peak runoff equation is obtained by substituting equations 2.13, 2.14, and 2.15 into equation 2.12.

$$q_p = \frac{(a)(Q)(A)}{360 (t_c)} \quad [2.16]$$

The time of concentration can be estimated by adding the surface and channel flow times:

$$t_c = t_{cc} + t_{cs} \quad [2.17]$$

where t_{cc} is the time of concentration for channel flow and t_{cs} is the time of concentration for surface flow (h). The t_{cc} can be computed by using the equation

$$t_{cc} = \frac{L_c}{v_c} \quad [2.18]$$

where L_c is the average channel flow length for the watershed (km) and v_c is the average channel velocity (m/s). The average channel flow length can be estimated by using the equation

$$L_c = \sqrt{(L) (L_{ca})} \quad [2.19]$$

where L is the channel length from the most distant point to the watershed outlet (km) and L_{ca} is the distance along the channel to the watershed centroid (km). Average velocity can be estimated by using Manning's equation and assuming a trapezoidal channel with 2:1 side slopes and a 10:1 bottom width/depth ratio. Substitution of these estimated and assumed values gives

$$t_{cc} = \frac{\sqrt{(L) (L_{ca})} (n)^{0.75}}{0.489 (q_c)^{0.25} (\sigma)^{0.375}} \quad [2.20]$$

where n is Manning's n , q_c is the average flow rate (m^3/s), and σ is the average channel slope (m/m). Assuming that $L_{ca}=0.5L$ and that the average flow rate is about 6.35 mm/h and is a function of the square root of drainage area, yields the final equation for t_{cc} :

$$t_{cc} = \frac{1.1 (L)(n)^{0.75}}{(A)^{0.125} (\sigma)^{0.375}} \quad [2.21]$$

A similar approach is used to estimate t_{cs} :

$$t_{cs} = \frac{\lambda}{v_s} \quad [2.22]$$

where λ is the surface slope length (m) and v_s is the surface flow velocity (m/s). Considering a strip 1 m wide down the sloping surface and applying Manning's equation gives

$$v_s = \frac{(q_s)^{0.4}(S)^{0.3}}{(n)^{0.6}} \quad [2.23]$$

where q_s is the average surface flow rate and S is the land surface slope (m/m). Assuming that the average flow rate is about 6.35 mm/h and making substitutions into equations 2.22 and 2.23 to convert from m^3/s to mm/h and from s to h, give the equation for estimating t_{cs} :

$$t_{cs} = \frac{(\lambda \cdot n)^{0.6}}{18 (S)^{0.3}} \quad [2.24]$$

Although some of the assumptions used in developing equations 2.21 and 2.24 may appear liberal, equation 2.17 generally gives satisfactory results for small homogeneous watersheds. Since equations 2.21 and 2.24 are based on hydraulic considerations, they are more reliable than purely empirical equations.

To properly evaluate a , variation in rainfall patterns must be considered. For some short duration storms, most or all the rain occurs during t_c causing a to approach its upper limit of 1.0. Other storms of uniform intensity cause a to approach a minimum value. All other patterns cause higher a values than the uniform pattern, because R_{t_c} is greater than R_{24} for all patterns except the uniform. By substituting the products of intensity and time into equation 2.15, an expression for the minimum value of a , a_{mm} , is obtained:

$$a_{mm} = \frac{t_c}{24} \quad [2.25]$$

Thus, a ranges within the limits

$$\frac{t_c}{24} \leq a \leq 1.0$$

Although confined between limits, the value of a is assigned with considerable uncertainty when only daily rainfall and simulated runoff amounts are given. Thus, a is generated from a gamma function with the base ranging from $t_c/24$ to 1.0.

The peak of the a distribution changes monthly because of seasonal differences in rainfall intensities. The Weather Service (U.S. Department of Commerce 1979) provides information on monthly maximum rainfall intensities that can be used to estimate the peak a for each month.

Since the water erosion model estimates the maximum 0.5-h amount of each daily rainfall ($a_{.5}$), these estimates are used in calculating a . Besides the convenience of avoiding double calculation, it is important to assure that $a_{.5}$ and a are closely related for each storm. The relationship between $a_{.5}$ and a can be obtained from TP-40 (Hershfield 1961) by fitting a log function to the 10-year frequency rainfall distribution:

$$R_t = R_6 \left(\frac{t}{6}\right)^b \quad [2.26]$$

where R_t is the rainfall amount (mm) for any time t , R_6 is the 6-h rainfall amount (mm), and b is a parameter used to fit the TP-40 relationship at any location. The value of a is computed with the equation

$$a = a_{.5} \frac{R_{tc}}{R_{.5}} \quad [2.27]$$

Details of the procedure for estimating $a_{.5}$ are given in the water erosion section of this chapter.

Percolation

The EPIC percolation component uses a storage routing technique to simulate flow through soil layers. Flow from a soil layer occurs when soil water content exceeds field capacity. Water drains from the layer until the storage returns to field capacity. The reduction in soil water is simulated with the routing equation

$$SW_\ell = (SW_{0\ell} - FC_\ell) \exp(-\Delta t / TT_\ell) + FC_\ell \quad [2.28]$$

where SW and SW_0 are the soil water contents at the end and the start of time interval Δt (24 h) and TT is travel time through layer ℓ (h).

Thus, daily percolation can be computed by taking the difference between SW and SW₀

$$O_{\ell} = (SW_{0\ell} - FC_{\ell}) [1.0 - \exp(-\Delta t / TT_{\ell})] \quad [2.29]$$

where O is the percolation rate for layer ℓ (in mm/d).

Travel time through a layer is computed with the linear storage equation

$$TT_{\ell} = \frac{P0_{\ell} - FC_{\ell}}{SC_{\ell}} \quad [2.30]$$

where $P0$ is the porosity (mm), FC is field capacity (mm), and SC is saturated conductivity--that is, rate of water drainage through a saturated layer--(mm/h).

The routing process is applied from the soil surface layer by layer through the deepest layer. Since the saturated conductivity of some layers may be much lower than that of others, the routing scheme can lead to an impossible situation (porosity of low saturated conductivity layers may be exceeded). For this reason, a back pass is executed from the bottom layer to the surface. If a layer's porosity is exceeded, the excess water is transferred to the layer above. This process continues through the top layer.

Saturated conductivity may be input or estimated for each soil layer by using the equation

$$SC_{\ell} = \frac{12.7 (100 - CLA_{\ell}) (SS_{\ell})}{100 - CLA_{\ell} + \exp[11.45 - 0.097 (100 - CLA_{\ell})]} \quad [2.31]$$

where CLA is the percentage of clay in soil layer ℓ and SS is the soil strength factor (described in the Growth Constraints section of this chapter).

Percolation is also affected by freezing temperature. Water can flow into a frozen layer but is not allowed to percolate from the layer.

Lateral Subsurface Flow

Lateral subsurface flow is calculated simultaneously with percolation. The lateral flow function (similar to equation 2.29) is expressed in the equation

$$QR_{\ell} = (SW_{0\ell} - FC_{\ell}) [1.0 - \exp(-1.0 / TT_{R\ell})] \quad [2.32]$$

where QR is the lateral flow rate for soil layer ℓ (mm/d) and $TT_{R\ell}$ is the lateral flow travel time (d).

The lateral flow travel time is estimated for each soil layer by using the equation

$$TT_{R\ell} = \frac{1000 (CLA_{\ell}) (SS_{\ell})}{CLA_{\ell} + \exp(10.047 - 0.148 CLA_{\ell})} + 10 \quad [2.33]$$

Equations 2.29 and 2.32 must be solved simultaneously to avoid one process dominating the other, simply because the solution occurs first. Thus, an equation for the sum of percolation and lateral flow is written as

$$0_{\ell} + QR_{\ell} = (SW_{0\ell} - FC_{\ell}) \left(1.0 - \exp\left(\frac{-\Delta t}{TT_{\ell}}\right) \exp\left(\frac{-1.0}{TT_{R\ell}}\right) \right) \quad [2.34]$$

Taking the ratio of $QR/0$ and substituting the resulting QR into equation 2.34 leads to the equation

$$0 + 0 \left(\frac{1.0 - \exp\left(\frac{-1.0}{TT_{R\ell}}\right)}{1.0 - \exp\left(\frac{-\Delta t}{TT_{\ell}}\right)} \right) = \dots (SW_{0\ell} - FC_{\ell}) \left(1.0 - \exp\left(\frac{-\Delta t}{TT_{\ell}}\right) \exp\left(\frac{-1.0}{TT_{R\ell}}\right) \right) \quad [2.35]$$

Solving for 0 gives the final percolation equation

$$0 = \frac{(SW_{0\ell} - FC_{\ell}) \left(1.0 - \exp\left(\frac{-\Delta t}{TT_{\ell}}\right) \exp\left(\frac{-1.0}{TT_{R\ell}}\right) \right) \left(1.0 - \exp\left(\frac{-\Delta t}{TT_{\ell}}\right) \right)}{2.0 - \exp\left(\frac{-\Delta t}{TT_{\ell}}\right) - \exp\left(\frac{-1.0}{TT_{R\ell}}\right)} \dots [2.36]$$

The calculated 0 value is substituted into equation 2.34 to obtain the final estimate of QR.

Evapotranspiration

The model offers two options for estimating potential evaporation--the Priestley-Taylor (1972) and Penman (1948) methods. The Penman method requires solar radiation, air temperature, wind speed, and relative humidity as inputs. If wind speed and relative humidity data are not available, the Priestley-Taylor method provides an option that usually gives realistic results. The model computes evaporation from soils and plants separately, as described by Ritchie (1972). Potential soil water evaporation is estimated as a function of potential evaporation and leaf area index (LAI, area of plant leaves relative to the soil surface area). Actual soil water evaporation is estimated by using exponential functions of soil depth and water content. Plant water evaporation is simulated as a linear function of potential evaporation and leaf area index.

Potential Evaporation

The Penman (1948) option for estimating potential evaporation is based on the equation

$$E_0 = \left(\frac{\delta}{\delta + \gamma} \right) \left(\frac{h_0 - G}{HV} \right) + \left(\frac{\gamma}{\delta + \gamma} \right) f(V) (e_a - e_d) \quad [2.37]$$

where E_0 is the potential evaporation (mm), δ is the slope of the saturation vapor pressure curve (kPa/°C), γ is a psychrometer constant (kPa/°C), h_0 is the net radiation (MJ/m²), G is the soil heat flux (MJ/m²), HV is the latent heat of vaporization (MJ/kg), $f(V)$ is a wind speed function (mm/d/kPa), e_a is the saturation vapor pressure at mean air temperature (kPa), and e_d is the vapor pressure at mean air temperature (kPa). The latent heat of vaporization is estimated with the temperature function

$$HV = 2.50 - 0.0022 T \quad [2.38]$$

where T is the mean daily air temperature (°C). The saturation vapor pressure is also estimated as a function of temperature by using the equation

$$e_a = 0.1 \exp \left(54.88 - 5.03 \ln(T + 273) - \frac{6791}{T + 273} \right) \quad [2.39]$$

The vapor pressure is simulated as a function of the saturation value and the relative humidity:

$$e_d = (e_a) (RH) \quad [2.40]$$

where RH is the relative humidity expressed as a fraction. The slope of the saturation vapor pressure curve is estimated with the equation

$$\delta = \left(\frac{e_a}{T + 273} \right) \left(\frac{6791}{T + 273} - 5.03 \right) \quad [2.41]$$

The psychrometer constant is computed with the equation

$$\gamma = 6.6 \times 10^{-4} \text{ PB} \quad [2.42]$$

where PB is the barometric pressure (kPa). The barometric pressure is estimated as a function of elevation by using the equation

$$\text{PB} = 101 - 0.0115 \text{ ELEV} + 5.44 \times 10^{-7} \text{ ELEV}^2 \quad [2.43]$$

where ELEV is the elevation of the site (m). The soil heat flux is estimated by using air temperature on the day of interest plus 3 days prior.

$$G = 0.12 \left(T_i - \left(\frac{T_{i-1} + T_{i-2} + T_{i-3}}{3} \right) \right) \quad [2.44]$$

where T is the mean daily air temperature on day i (°C). Solar radiation is adjusted to obtain net radiation by using the equation

$$h_{oi} = \text{RA}_i (1.0 - \text{AB}_i) - \text{RAB}_i \left(\frac{0.9 \text{RA}_i}{\text{RAMX}_i} + 0.1 \right) \quad [2.45]$$

where RA is the solar radiation (MJ/m²), AB is albedo, RAB is the net outgoing long wave radiation (MJ/m²) for clear days, and RAMX is the maximum solar radiation possible (MJ/m²) for the location on day i. The RAB value is estimated with the equation

$$\text{RAB}_i = 4.9 \times 10^{-9} (0.34 - 0.14 \sqrt{e_d}) (T_i + 273)^4 \quad [2.46]$$

The maximum possible solar radiation is computed with the equations

$$\text{RAMX} = 30 \left[1.0 + 0.0335 \sin \left[\frac{2\pi}{365} (i + 88.2) \right] \right]$$

$$\dots\dots \left(XT \sin\left(\frac{2\pi}{360} \text{LAT}\right) \sin(\text{SD}) + \cos\left(\frac{2\pi}{360} \text{LAT}\right) \cos(\text{SD}) \sin(XT) \right) \dots\dots \quad [2.47]$$

$$XT = \cos^{-1} \left(-\tan\left(\frac{2\pi}{360} \text{LAT}\right) \tan(\text{SD}) \right), \quad 0 \leq XT \leq \pi \quad [2.48]$$

where LAT is the latitude of the site in degrees, SD is the sun's declination angle (radians), and i is the day of the year. The sun's declination angle is calculated with the equation

$$SD_i = 0.4102 \sin\left[\frac{2\pi}{365} (i - 80.25)\right] \quad [2.49]$$

Finally, the wind function of the Penman equation is approximated with the relationship

$$f(V) = 2.7 + 1.63 V \quad [2.50]$$

where V is the mean daily wind speed at a 10-m height (m/s).

The Priestley-Taylor (1972) method provides estimates of potential evaporation without wind and relative humidity inputs. The simplified equation based only on temperature and radiation is

$$E_o = 30.6 (h_o) \left(\frac{\delta}{\delta + 0.68} \right) \quad [2.51]$$

The net radiation is estimated with the equation

$$h_{oi} = \frac{2\pi}{365} RA_i (1 - AB_i) \quad [2.52]$$

instead of equation 2.45, which is used in the Penman method. Similarly, equation 2.41 is replaced to estimate the slope of the saturation vapor pressure curve with the equation

$$\delta = \exp \left(21.3 - \frac{5304}{(T + 273)} \right) \left(\frac{5304}{(T + 273)^2} \right) \quad [2.53]$$

Both methods estimate albedo by considering the soil, crop, and snow cover. If a snow cover exists with 5 mm or greater water content, the value of albedo is set to 0.6. If the snow cover is less than 5 mm and no crop is growing, the soil albedo is the appropriate value. When crops are growing, albedo is determined by using the equation

$$AB = 0.23 (1.0 - EA) + (AB_s) (EA) \quad [2.54]$$

where 0.23 is the albedo for plants, AB_s is the soil albedo, and EA is a soil cover index. The value of EA ranges from 0 to 1.0 according to the equation

$$EA = \exp(-0.1 CV) \quad [2.55]$$

where CV is the sum of the above ground biomass and crop residue (t/ha).

Soil and Plant Evaporation

The model computes evaporation from soils and plants separately by an approach similar to that of Ritchie (1972). Potential plant water evaporation is computed with the equations

$$E_p = \frac{(E_o) (LAI)}{3.0}, \quad 0 \leq LAI \leq 3.0 \quad [2.56]$$

$$E_p = E_o, \quad LAI > 3.0 \quad [2.57]$$

where E_p is the predicted plant water evaporation rate (mm/d). If soil water is limited, plant water evaporation will be reduced as described in the plant growth section of this chapter.

Potential soil water evaporation is simulated by considering soil cover according to the following equation

$$E_s = \min[(E_o) (EA), E_o - E_p] \quad [2.58]$$

where E_s is the potential soil water evaporation rate (mm/d).

Actual soil water evaporation is estimated on the basis of the top 0.2 m of soil and snow cover, if any. If snow is present, it is evaporated at the potential soil water evaporation rate. When all snow is evaporated, soil water evaporation begins. Such evaporation is governed by soil depth and water content according to the equation

$$EV_Z = E_s \left(\frac{Z / 0.2}{Z / 0.2 + \exp[-2.92 - 1.43 (\frac{Z}{0.2})]} \right) \quad [2.59]$$

where EV is the total soil water evaporation (mm) from soil of depth Z (m). Potential soil water evaporation for a layer is estimated by taking the difference between EV's at the layer boundaries:

$$SEV_{\ell} = EV_{Z(\ell)} - EV_{Z(\ell-1)} \quad [2.60]$$

where SEV is the potential soil evaporation for layer ℓ (mm).

The depth distributed estimate of soil water evaporation may be reduced according to the following equation if soil water is limited in a layer:

$$SEV_{\ell}^* = SEV_{\ell} \exp \left(\frac{2.5 (SW_{\ell} - FC_{\ell})}{FC_{\ell} - WP_{\ell}} \right), \quad SW_{\ell} < FC_{\ell} \quad [2.61]$$

where SEV_{ℓ}^* is the adjusted soil water evaporation estimate (mm).

$$SEV_{\ell}^* = SEV_{\ell}, \quad SW_{\ell} \geq FC_{\ell} \quad [2.62]$$

The final step in adjusting the evaporation estimate is to assure that the soil water supply is adequate to meet the demand:

$$SEV_{\ell}^* = \min(SEV_{\ell}^*, SW_{\ell} - 0.5 WP_{\ell}) \quad [2.63]$$

Equation 2.63 allows soil in the top 0.2 m to dry to half the soil water content corresponding to the wilting point.

Snowmelt

The EPIC snowmelt component is similar to that of the CREAMS model (Knisel 1980). If snow is present, it is melted on days when the maximum temperature exceeds 0.0°C by using the equations

$$SML = 4.57 T_{mx}, \quad SML < SNO \quad [2.64]$$

$$SML = SNO \quad [2.65]$$

where SML is the snowmelt rate (mm/d), T_{mx} is the daily maximum air temperature (°C), and SNO is the water content of snow before melt occurs (mm). Melted snow is treated the same as rainfall for estimating runoff volume and percolation, but rainfall energy is set to 0.0 and peak runoff rate is estimated by assuming uniformly distributed rainfall for a 24-h duration.

Water Table Dynamics

The water table height is simulated without direct linkage to other soil water processes in the root zone to allow for offsite water effects. The model drives the water table up and down between input values of maximum and minimum depths from the surface. The driving mechanism is a function of rainfall, surface runoff, and potential evaporation, as given in the equation

$$WTBL_i = WTBL_{i-1} - W1(WTBL_{i-1} - WTL) \quad [2.66]$$

where $WTBL$ is the depth (m) from the surface to the water table on day i , $W1$ is the driving function, and WTL is the appropriate limit. The driving equations are

$$W1 = \min(0.1, |W2|) \quad [2.67]$$

$$W2 = \frac{RFS - QS - EOS}{EOS} \quad [2.68]$$

where RFS , QS , and EOS are the sums of rainfall, runoff, and potential evaporation for 30 days before day i and $W2$ is a scaling factor. Equation 2.68 causes the water table to rise faster than it falls because the denominator is larger during recession.

The maximum water table depth, $WTMX$, is substituted into equation 2.66 for WTL when the water table is falling. Conversely, WTL is set to the minimum water table depth, $WTMN$, on the rising side.

$$WTL = WTMX, \quad W2 \leq 0.0 \quad [2.69]$$

$$WTL = WTMN, \quad W2 > 0.0 \quad [2.70]$$

Obviously, equation 2.66 gives highest rising rates when $W2$ is large and when $WTBL \approx WTMX$. As $WTBL \approx WTMN$ the rate of rise approaches zero. The reverse is true on the falling side.

Weather

The weather variables necessary for driving the EPIC model are precipitation, air temperature, and solar radiation. If the Penman method is used to estimate potential evaporation, wind speed and relative humidity are also required. Of course, wind speed is also needed when wind-induced erosion is simulated. If daily precipitation, air temperature, and solar radiation data are available, they can be input directly into EPIC. Rainfall and temperature data are available for many areas of the United States, but solar radiation, relative humidity, and wind data are scarce. Even rainfall and temperature data are generally not

adequate for the long-term EPIC simulations (100 years+). Thus, EPIC provides options for simulating various combinations of the five weather variables. Descriptions of the models used for simulating precipitation, temperature, radiation, relative humidity, and wind follow.

Precipitation

The EPIC precipitation model developed by Nicks (1974) is a first-order Markov chain model. Thus, input for the model must include monthly probabilities of receiving precipitation. On any given day, the input must include information as to whether the previous day was dry or wet. A random number (0-1) is generated and compared with the appropriate wet-dry probability. If the random number is less than or equal to the wet-dry probability, precipitation occurs on that day. Random numbers greater than the wet-dry probability give no precipitation. Since the wet-dry state of the first day is established, the process can be repeated for the next day and so on throughout the simulation period.

If wet-dry probabilities are not available, the average monthly number of rainy days may be substituted. The probability of a wet day is calculated directly from the number of wet days:

$$PW = NWD / ND \quad [2.71]$$

where PW is the probability of a wet day, NWD is the number of rainy days, and ND is the number of days, in a month. The probability of a wet day after a dry day can be estimated as a fraction of PW.

$$P(W/D) = \beta PW \quad [2.72]$$

where P(W/D) is the probability of a wet day following a dry day and where β is a fraction usually in the range of 0.6 to 0.9. The probability of a wet day following a wet day can be calculated directly by using the equation

$$P(W/W) = 1.0 - \beta + P(W/D) \quad [2.73]$$

where P(W/W) is the probability of a wet day after a wet day. When $\beta \rightarrow 1.0$, wet days do not affect probability of rainfall-- P(W/D)=P(W/W)=PW. Conversely, low β values give strong wet day effects-- $\beta \rightarrow 0.0$, P(W/D) $\rightarrow 0.$, P(W/W) $\rightarrow 1.0$. Thus, β controls the interval between rainfall events but has no effect on the number of wet days. For many locations, $\beta=0.75$ gives satisfactory estimates of P(W/D). Although equations 2.72 and 2.73 may give slightly different probabilities than those estimated from rainfall records, they do guarantee correct simulation of the number of rainfall events.

When a precipitation event occurs, the amount is generated from a skewed normal daily precipitation distribution:

$$R_i = \left(\frac{\left(\left(\text{SND}_i - \frac{\text{SCF}_k}{6.0} \right) \left(\frac{\text{SCF}_k}{6.0} \right) + 1 \right)^3 - 1.}{\text{SCF}_k} \right) \text{RSDV}_k + \bar{R}_k \quad [2.74]$$

where R is the amount of rainfall for day i (mm), SND is the standard normal deviate for day i , SCF is the skew coefficient, RSDV is the standard deviation of daily rainfall (mm), and \bar{R} is the mean daily rainfall in month k .

If the standard deviation and skew coefficient are not available, the model simulates daily rainfall by using a modified exponential distribution.

$$R_i = \frac{(-\ln(\mu))^\zeta \bar{R}_k}{\int_{0.0}^{1.0} (-\ln(x))^\zeta dx} \quad [2.75]$$

where μ is a uniform random number (0.0-1.0) and ζ is a parameter usually in the range of 1.0 to 2.0. The larger the ζ value, the more extreme the rainfall events. A value of 1.5 gives satisfactory results at many locations in the United States. The denominator of equation 2.75 assures that the long-term simulated rainfall amount agrees with \bar{R} . The modified exponential is usually a satisfactory substitute and requires only the monthly mean daily rainfall as input.

The amount of daily precipitation is partitioned between rainfall and snowfall according to the average daily air temperature. If the average is 0°C or below, the precipitation is snowfall; otherwise, it is rainfall.

Air Temperature and Solar Radiation

The model developed by Richardson (1981) was selected for use in EPIC because it simulates temperature and radiation, which are mutually correlated with rainfall. The residuals of daily maximum and minimum air temperature and solar radiation are generated from a multivariate normal distribution.

The multivariate generation model used implies that the residuals of maximum temperature, minimum temperature, and solar radiation are normally distributed and that the serial correlation of each variable may be described by a first-order linear autoregressive

model. Details of the multivariate generation model were described by Richardson (1981). The dependence structure of daily maximum temperature, minimum temperature, and solar radiation was described by Richardson (1982).

The temperature model requires monthly means of maximum and minimum temperatures and their standard deviations as inputs. If the standard deviations are not available, the long-term observed extreme monthly minimums and maximums may be substituted. The model estimates standard deviation as 0.25 of the difference between the extreme and the mean for each month. For example,

$$SDTMX_k = 0.25 (TE_{mx,k} - \bar{T}_{mx,k}) \quad [2.76]$$

where SDTMX is the standard deviation of the daily maximum temperature, TE is the extreme daily maximum temperature, and \bar{T} is the average daily maximum temperature for month k.

The solar radiation model uses the extreme approach extensively. Thus, only the monthly means of daily solar radiation are required as inputs. The equation for estimating standard deviation is

$$SDRA_k = 0.25 (RAMX_k - \bar{RA}_k) \quad [2.77]$$

where SDRA is the standard deviation of daily solar radiation (MJ/m^2), RAMX is the maximum daily solar radiation at midmonth, and \bar{RA} is the mean daily solar radiation for month k.

Maximum temperature and solar radiation tend to be lower on rainy days. Thus, it is necessary to adjust the mean maximum temperature and solar radiation downward for simulating rainy day conditions. For T_{mx} this is accomplished by assuming that wet day values are less than dry day values by some fraction of $T_{mx} - T_{mn}$:

$$TW_{mx,k} = TD_{mx,k} - \Omega_T (T_{mx,k} - T_{mn,k}) \quad [2.78]$$

where TW is the daily mean maximum temperature for wet days ($^{\circ}C$) in month k, TD is the daily mean maximum temperature for dry days, Ω_T is a scaling factor ranging from 0.0 to 1.0, T_{mx} is the daily mean maximum temperature, and T_{mn} is the daily mean minimum temperature. Choosing $\Omega_T=1.0$ provides highest deviations on wet days and $\Omega_T=0.0$ ignores the wet day effect. Observed data indicate that Ω_T usually lies between 0.5 and 1.0.

Since equation 2.78 gives lower mean maximum temperature values for wet days, a companion equation is necessary to slightly increase mean maximum temperature for dry days. The development is taken directly from the continuity equation

$$(T_{mx,k}) (ND_k) = (TW_{mx,k}) (NWD_k) + (TD_{mx,k}) (NDD_k) \quad [2.79]$$

where ND is the number of days in a month, NWD is the number of wet days, and NDD is the number of dry days. The desired equation is obtained by substituting equation 2.78 into equation 2.79 and solving for TD:

$$TD_{mx,k} = T_{mx,k} + \left(\frac{NWD_k}{ND_k} \right) \Omega_T (T_{mx,k} - T_{mn,k}) \quad [2.80]$$

Use of the continuity equation guarantees that the long-term simulated value for mean maximum temperature agrees with the input value of T_{mx} .

The method of adjusting solar radiation for wet and dry days is similar to that of adjusting maximum temperature. The radiation on wet days is a fraction of the dry day radiation:

$$RAW_k = \Omega_R RAD_k \quad [2.81]$$

where RAW is the daily mean solar radiation on wet days (MJ/m^2), Ω_R is a scaling factor ranging from 0.0 to 1.0, and RAD is the daily mean solar radiation on dry days. An Ω_R value of 0.5 gives satisfactory results for many locations. The dry day equation is developed by replacing temperature with radiation in equation 2.79 and substituting equation 2.81 for RAW. Then,

$$RAD_k = \frac{(RA_k) (ND_k)}{\Omega_R (NWD_k) + NDD_k} \quad [2.82]$$

where RA is the daily mean solar radiation for month k (MJ/m^2).

Wind

The wind simulation model was developed by Richardson and Wright (1984) for EPIC. The two wind variables considered are average daily velocity and daily direction. Average daily wind velocity is generated from a two-parameter gamma distribution of the dimensionless form

$$U = \left(\frac{V}{V_p}\right)^{\eta-1} \exp\left[-(\eta-1)\left(1 - \frac{V}{V_p}\right)\right] \quad [2.83]$$

where U is a dimensionless variable (0-1) expressing frequency with which wind velocity V (m/s) occurs, V_p is the wind velocity at the peak frequency, and η is the gamma distribution shape parameter. The shape parameter is calculated with the equation

$$\eta = \frac{\bar{V}^2}{SDV^2} \quad [2.84]$$

where \bar{V} is the annual average wind velocity (m/s) and SDV is the standard deviation of daily wind velocity (m/s). Values for the average annual wind velocity and the standard deviation of hourly wind are provided by the "Climatic Atlas of the United States" (U.S. Department of Commerce 1968). By experimenting with standard deviations of hourly and daily wind, a correction factor of 0.7 was found to be appropriate for converting hourly standard deviations to daily. The base of the dimensionless gamma distribution (maximum V/V_p) can be determined by Newton's classical method of solving nonlinear equations. The objective function is to select the base to minimize the sum of $\ln(U)$ and 11.5. The value of V_p can be determined by differentiating the gamma function expressed in terms of V and setting the result equal to zero. Then,

$$V_p = \frac{V_k (\eta - 1)}{\eta} \quad [2.85]$$

where V_k is the mean daily wind velocity for month k . The rejection technique is used to generate a daily value of V/V_p . The daily wind velocity is then computed by using the equation

$$V_i = (V_{pk}) \left(\frac{V}{V_p}\right) \quad [2.86]$$

where V_i is the generated velocity for day i , V_{pk} is the peak velocity for month k , and V/V_p is the value generated by the rejection technique.

Wind direction expressed as radians from north in a clockwise direction is generated from an empirical distribution specific for each location. The empirical distribution is simply the cumulative probability distribution of wind direction. The "Climatic Atlas of the United States" gives monthly percentages of wind from each of 16 directions. Thus, to estimate wind direction for any day, the model draws a uniformly distributed random number and locates its position on the appropriate monthly cumulative probability distribution.

Relative Humidity

The relative humidity model simulates daily average relative humidity from the monthly average by using a triangular distribution. As with temperature and radiation, the mean daily relative humidity is adjusted to account for wet- and dry-day effects. The assumed relation between relative humidity on wet and dry days is

$$RHW_k = RHD_k + \Omega_H (1.0 - RHD_k) \quad [2.87]$$

where RHW is the daily mean relative humidity on wet days for month k , RHD is the daily mean relative humidity on dry days, and Ω_H is a scaling factor ranging from 0.0 to 1.0. An Ω_H value of 0.9 seems appropriate for many locations. Using the continuity equation as described in the temperature and radiation sections produces the equation

$$RHD_k = \frac{RH_k - \Omega_H \left(\frac{NWD}{ND} \right)}{1.0 - \Omega_H \left(\frac{NWD}{ND} \right)} \quad [2.88]$$

where RH is the long-term average relative humidity for month k .

The appropriate value (RHW or RHD) is used as the peak of a triangular distribution to generate daily relative humidity. The upper limit of the triangular distribution is set with the equation

$$RHU_i = RHP_i + (1.0 - RHP_i) \exp(RHP_i - 1.0) \quad [2.89]$$

where RHU is the largest relative humidity value that can be generated on day i and RHP is the peak of the triangular distribution (RHW or RHD). The lower limit is set with the equation

$$RHL_i = RHP_i [1.0 - \exp(-RHP_i)] \quad [2.90]$$

where RHL is the lowest relative humidity value that can be generated on day i.

To assure that the simulated long-term value for mean relative humidity agrees with input RH, the generated value is adjusted by using the equation

$$RHG_i^* = RHG_i \left(\frac{RHP_i}{RH_i} \right) \quad [2.91]$$

where RHG* is the generated relative humidity on day i adjusted to the mean of the triangle, RHG is the relative humidity generated from the triangle, and RH is the mean of the triangle.

Erosion

Water

Rainfall/Runoff

The EPIC component for water-induced erosion simulates erosion caused by rainfall and runoff and by irrigation (sprinkler and furrow). To simulate rainfall/runoff erosion, EPIC contains three equations--the USLE (Wischmeier and Smith 1978), the MUSLE (Williams 1975), and the Onstad-Foster modification of the USLE (Onstad and Foster 1975). Only one of the equations (user specified) interacts with other EPIC components. The three equations are identical except for their energy components. The USLE depends strictly upon rainfall as an indicator of erosive energy. The MUSLE uses only runoff variables to simulate erosion and sediment yield. Runoff variables increased the prediction accuracy, eliminated the need for a delivery ratio (used in the USLE to estimate sediment yield), and enables the equation to give single storm estimates of sediment yields. The USLE gives only annual estimates. The Onstad-Foster equation contains a combination of the USLE and MUSLE energy factors.

Thus, the water erosion model uses an equation of the form

$$Y = \chi (K) (CE) (PE) (LS) (ROKF) \quad [2.92]$$

$$\chi = EI \quad \text{for USLE}$$

$$\chi = 11.8 (Q^* \cdot q_p)^{0.56} \quad \text{for MUSLE}$$

$$\chi = 0.646 EI + 0.45 (Q \cdot q_p^*)^{0.33} \quad \text{for Onstad-Foster}$$

where Y is the sediment yield (t/ha), K is the soil erodibility factor, CE is the crop management factor, PE is the erosion control practice factor, LS is the slope length and steepness factor, ROKF is the coarse fragment factor, EI is the rainfall energy factor, Q* is the runoff volume (m³), q_p is the peak runoff rate (m³/s), Q is the runoff volume (mm), and q*_p is the peak runoff rate (mm/h). The PE value is determined initially by considering the conservation practices to be applied. The value of LS is calculated with the equation (Wischmeier and Smith 1978)

$$LS = \left(\frac{\lambda}{22.1}\right) \xi (65.41 S^2 + 4.56 S + .065) \quad [2.93]$$

where S is the land surface slope (m/m), λ is the slope length (m), and ξ is a parameter dependent upon slope. The value of ξ varies with slope and is estimated with the equation

$$\xi = 0.3 S / [S + \exp(-1.47 - 61.09 S)] + 0.2 \quad [2.94]$$

The crop management factor is evaluated for all days when runoff occurs by using the equation

$$CE = \exp[(\ln 0.8 - \ln CE_{mn,j}) \exp(-1.15 CV) + \ln CE_{mn,j}] \quad \dots [2.95]$$

where CE_{mn,j} is the minimum value of the crop management factor for crop j and CV is the soil cover (above ground biomass plus residue) (t/ha).

The soil erodibility factor, K, is evaluated for the top soil layer at the start of each year of simulation with the equation

$$K = \left(0.2 + 0.3 \exp\left[-0.0256 SAN (1 - SIL / 100)\right]\right) \left(\frac{SIL}{CLA + SIL}\right)^{0.3} \\ \dots \left(1.0 - \frac{0.25 C}{C + \exp(3.72 - 2.95 C)}\right) \\ \dots \left(1.0 - \frac{0.7 SN1}{SN1 + \exp(-5.51 + 22.9 SN1)}\right) \quad [2.96]$$

where SAN, SIL, CLA, and C are the sand, silt, clay, and organic carbon contents of the soil (%) and SN1=1-SAN/100. Equation 2.96 allows K to vary from about 0.1 to 0.5. The first term gives low K values for soils with high coarse-sand contents and high values for soils with little sand. The fine sand content is estimated as the product of sand and silt divided by 100. The expression

for coarse sand in the first term is simply the difference between sand and the estimated fine sand. The second term reduces K for soils that have high clay to silt ratios. The third term reduces K for soils with high organic carbon contents. The fourth term reduces K further for soils with extremely high sand contents (SAN>70%).

The runoff model supplies estimates of Q and q_p . To estimate the daily rainfall energy in the absence of time-distributed rainfall, it is assumed that the rainfall rate is exponentially distributed:

$$r_t = r_p \exp(-t / \kappa) \quad [2.97]$$

where r is the rainfall rate at time t (mm/h), r_p is the peak rainfall rate (mm/h), and k is the decay constant (h). Equation 2.97 contains no assumption about the sequence of rainfall rates (time distribution). The USLE energy equation in metric units is

$$RE = \Delta R (12.1 + 8.9 \log \frac{R}{\Delta t}) \quad [2.98]$$

where RE is the rainfall energy for water erosion equations and ΔR is a rainfall amount (mm) during a time interval Δt (h). The energy equation can be expressed analytically as

$$RE = 12.1 \int_0^{\infty} r dt + 8.9 \int_0^{\infty} r \log r dt \quad [2.99]$$

Substituting equation 2.97 into equation 2.99 and integrating give the equation for estimating daily rainfall energy:

$$RE = R [12.1 + 8.9 (\log r_p - 0.434)] \quad [2.100]$$

where R is the daily rainfall amount (mm). The rainfall energy factor, EI, is obtained by multiplying equation 2.100 by the maximum 0.5-h rainfall intensity ($r_{.5}$) and converting to the proper units:

$$EI = R [12.1 + 8.9 (\log r_p - 0.434)] (r_{.5}) / 1000 \quad [2.101]$$

To compute values for r_p , equation 2.97 is integrated to give

$$R = (r_p) (\kappa) \quad [2.102]$$

and

$$R_t = R [1 - \exp(-t / \kappa)] \quad [2.103]$$

The value of $R_{.5}$ can be estimated by using $a_{.5}$, as mentioned in the Hydrology section of this chapter:

$$R_{.5} = a_{.5} R \quad [2.104]$$

To determine the value of r_p , equations 2.104 and 2.102 are substituted into equation 2.103 to give

$$r_p = -2 R \ln(1 - a_{.5}) \quad [2.105]$$

Since rainfall rates vary seasonally, $a_{.5}$ is evaluated for each month by using Weather Service information (U.S. Department of Commerce 1979). The frequency with which the maximum 0.5-h rainfall amount occurs is estimated by using the Hazen plotting position equation (Hazen 1930)

$$F = \frac{1}{2\tau} \quad [2.106]$$

where F is the frequency with which the largest of a total of τ events occurs. The total number of events for each month is the product of the number of years of record and the average number of rainfall events for the month. To estimate the mean value of $a_{.5}$, it is necessary to estimate the mean value of $R_{.5}$. The value of $R_{.5}$ can be computed easily if the maximum 0.5-h rainfall amounts are assumed to be exponentially distributed. From the exponential distribution, the expression for the mean 0.5-h rainfall amount is

$$\bar{R}_{.5,k} = \frac{R_{.5F,k}}{-\ln F_k} \quad [2.107]$$

where $\bar{R}_{.5,k}$ is the mean maximum 0.5-h rainfall amount, $R_{.5F,k}$ is the maximum 0.5-h rainfall amount for frequency F , and subscript k refers to the month. The mean $a_{.5}$ is computed with the equation

$$a_{.5,k} = \frac{\bar{R}_{.5,k}}{\bar{R}_k} \quad [2.108]$$

where \bar{R} is the mean amount of rainfall for each event (average monthly rainfall/average number of days of rainfall) and subscript k refers to the month. Daily values of $a_{.5}$ are generated from a two-parameter gamma distribution. The base of the gamma distribution is established by examining upper and lower limits of $a_{.5}$. The lower limit determined by a uniform rainfall rate gives $a_{.5}$ equal to 0.5/24 or 0.0208. The upper limit of $a_{.5}$ is set by considering a large rainfall event. In a large event, it is highly unlikely that all the rainfall occurs in 0.5 h ($a=1.$). The upper limit of $a_{.5}$ can be estimated by substituting a high value for r_p (250 mm/h is generally near the upper limit of rainfall intensity) into equation 2.103.

$$a_{.5u} = 1 - \exp(-125 / R) \quad [2.109]$$

where $a_{.5u}$ is the upper limit of $a_{.5}$. The peak of the $a_{.5}$ gamma distribution can be computed by using equation 2.85 written in the form

$$a_{.5P,k} = \frac{a_{.5,k} (\nu - 1)}{\nu} \quad [2.110]$$

where $a_{.5P,k}$ is the $a_{.5}$ value at the peak of the gamma distribution and ν is the gamma distribution shape parameter (a value of 10 is generally satisfactory), and k is the month.

The coarse fragment factor is estimated with the equation (Simanton et al. 1984)

$$ROKF = \exp(-.03 ROK) \quad [2.111]$$

where ROK is the percent of coarse fragments in the surface soil layer

Irrigation

Erosion caused by applying irrigation water in furrows is estimated with MUSLE (Williams 1975):

$$Y = 11.8 (Q^* \cdot q_p)^{0.56} (K) (CE) (PE) (LS) \quad [2.112]$$

where CE, the crop management factor, has a constant value of 0.5. The volume of runoff is estimated as the product of the irrigation volume applied and the irrigation runoff ratio.

The peak runoff rate is estimated for each furrow by using Manning's equation and assuming that the flow depth is 0.75 of the ridge height and that the furrow is triangular. If irrigation water is applied to land without furrows, the peak runoff rate is assumed to be 0.00189 m³/s per meter of field width.

Wind

The Manhattan, KS, equation for wind-induced erosion (Woodruff and Siddoway 1965) was modified by Cole et al. (1982) for use in the EPIC model. The original wind erosion equation is of the form

$$WE = f (I, WC, WK, WL, VE) \quad [2.113]$$

where WE is the soil loss from wind erosion (t/ha), I is the soil erodibility index (t/ha), WC is the climatic factor, WK is the soil ridge roughness factor, WL is the field length (mm) along the prevailing wind direction, and VE is the quantity of vegetative cover expressed as small grain equivalent (kg/ha).

Equation 2.113 was developed for predicting average annual wind erosion. Its main modification allows EPIC to predict daily values for WE.

Two of the variables, I and WC, remain constant for each day of a year. The soil erodibility index is calculated at the start of each year by using a soil textural triangle. Annual I evaluations are necessary to reflect changes in soil surface texture caused by tillage and erosion. The climatic factor, WC, is estimated only once (at the start of a simulation) as described by Lyles (1983). Lyles' method, based on the Thornthwaite precipitation-evaporation index (Thornthwaite 1931) is expressed in the equations

$$WC = \frac{386 V^3}{\left(\sum_{i=1}^{12} 10(R - E)_i \right)^2} \quad [2.114]$$

and

$$10(R - E) = 115 \left(\frac{R / 25.4}{1.8 T + 22} \right)^{10/9} \quad [2.115]$$

$$R \geq 12.7 \text{ mm,}$$

$$T \geq - 1.7^\circ\text{C}$$

where \bar{V} is the average annual windspeed (m/s) and R, E, and T are the average values of precipitation (mm), evaporation (mm), and temperature ($^{\circ}\text{C}$) for month i.

The other variables in equation 2.113 are subject to daily variation. The ridge roughness is a function of a row height and row interval

$$KR = \frac{4000 HR^2}{IR} \quad [2.116]$$

where KR is the ridge roughness (mm), HR is the ridge height (m), and IR is the ridge interval (m). The ridge roughness factor is a function of ridge roughness as expressed by the equations

$$WK = 1. , \quad KR < 2.27 \quad [2.117]$$

$$WK = 1.125 - 0.153 \ln (KR) , \quad 2.27 \leq KR < 89. \quad [2.118]$$

$$WK = 0.336 \exp(0.00324 KR) , \quad KR \geq 89. \quad [2.119]$$

Field length along the prevailing wind direction is calculated by considering the field dimensions and orientation and the wind direction:

$$WL = \frac{(FL) (FW)}{FL \left| \cos\left(\frac{\pi}{2} + \theta - \phi\right) \right| + FW \left| \sin\left(\frac{\pi}{2} + \theta - \phi\right) \right|} \quad [2.120]$$

where FL is the field length (m), FW is the field width (m), θ is the wind direction clockwise from north in radians, and ϕ is the clockwise angle between field length and north in radians.

The vegetative cover equivalent factor is simulated daily as a function of the amounts of standing live biomass, standing dead residue, and flat crop residue.

$$VE = 0.2533 (g_1 B_{AG} + g_2 SR + g_3 FR)^{1.363} \quad [2.121]$$

where g_1 , g_2 , and g_3 are crop specific coefficients, B_{AG} is the above ground biomass of a growing crop (t/ha), SR is the standing residue from the previous crop (t/ha), and FR is the flat residue (t/ha). Thus, all variables in equation 2.113 can be evaluated. To estimate the soil loss from wind erosion, however, requires a special combination of the factors as follows:

$$E2 = (WK) (I) \quad [2.122]$$

$$E3 = (WK) (I) (WC) \quad [2.123]$$

$$WL_0 = 1.56 \times 10^6 (E2)^{-1.26} \exp(-0.00156 E2) \quad [2.124]$$

$$WF = E2 [1. - 0.1218 (WL/WL_0)^{-0.3829} \exp(-3.33 WL/WL_0)] \quad [2.125]$$

$$E4 = (WF^{0.3484} + E3^{0.3484} - E2^{0.3484})^{2.87} \quad [2.126]$$

$$E5 = \psi_1 E4^{\psi_2} \quad [2.127]$$

$$WE = (E5) (DE) / (AE) \quad [2.128]$$

where field lengths greater than WL_0 (m) do not reduce the erosion estimate, WF is the field length factor, ψ_1 and ψ_2 are parameters, DE is the daily wind energy (kWh/m²), and AE is the average annual wind energy (kWh/m²). The parameters ψ_1 and ψ_2 are the functions of the vegetative cover factor described by the equations

$$\psi_2 = 1. + 8.93 \times 10^{-5} VE + 8.51 \times 10^{-9} VE^2 - 1.59 \times 10^{-13} VE^3 \quad [2.129]$$

$$\psi_1 = \exp(-7.59 \times 10^{-4} VE - 4.74 \times 10^{-8} VE^2 + 2.95 \times 10^{-13} VE^3) \quad [2.130]$$

Daily wind energy is estimated with the equation

$$DE = 193 \exp\left[1.103 \left(\frac{V - 30}{V + 1}\right)\right] \quad [2.131]$$

where V is the daily average wind velocity (m/s). Average annual wind energy is estimated by integrating the monthly gamma distributions of wind velocity

$$AE = 30.4 \sum_{k=1}^{12} \left(\frac{\int_{V_L}^{V_u} (DE)_k (\chi)_k dV}{\int_{V_L}^{V_u} \chi_k dV} \right) \quad [2.132]$$

where V_u is the upper limit of wind speed, V_l is the lower limit of erosive wind speed, and χ is the frequency of occurrence of wind speed V .

Nutrients

Nitrogen

Nitrate Loss in Surface Runoff

The amount of NO_3-N in runoff is estimated by considering the top soil layer (10-mm thickness) only. The total amount of water leaving the layer is the sum of runoff, lateral subsurface flow, and percolation:

$$QT = Q + Q_\ell + QR_\ell \quad [2.133]$$

where QT is the total water lost from the first layer (mm). The amount of NO_3-N lost with QT is

$$VN03 = (QT) (c_{N03}) \quad [2.134]$$

where $VN03$ is the amount of NO_3-N lost from the first layer and c_{N03} the concentration of NO_3-N in the first layer. At the end of the day, the amount of NO_3-N left in the layer is

$$WN03 = WN03_0 - (QT) (c_{N03}) \quad [2.135]$$

where $WN03_0$ and $WN03$ are the weights of NO_3-N contained in the layer at the beginning and ending of the day. The NO_3-N concentration can be estimated by dividing the weight of NO_3-N by the water storage volume:

$$c'_{N03} = c_{N03} - c_{N03} \left(\frac{QT}{P0_\ell - WP_\ell} \right) \quad [2.136]$$

where c'_{N03} is the concentration of NO_3-N at the end of a day, $P0$ is the soil porosity, and WP is the wilting point water content (mm) for soil layer ℓ . Equation 2.136 is a finite difference approximation for the exponential equation

$$c'_{N03} = c_{N03} \exp\left(\frac{-QT}{P0_\ell - WP_\ell}\right) \quad [2.137]$$

Thus, VN03 can be computed for any QT value by integrating equation 2.137:

$$VN03 = WN03 \left[1 - \exp\left(\frac{-QT}{P0_{\ell} - WP_{\ell}}\right) \right] \quad [2.138]$$

The average concentration of QT for the day is

$$c_{NO3} = \frac{VN03}{QT} \quad [2.139]$$

Amounts of NO₃-N contained in runoff, lateral flow, and percolation are estimated as the products of the volume of water and the concentration from equation 2.139.

NO₃-N Leaching

Leaching and lateral subsurface flow in lower layers are treated by the same approach used for the upper layer except that surface runoff is not considered.

NO₃-N Transport by Soil Water Evaporation

When water is evaporated from the soil, NO₃-N is moved upward into the top soil layer by mass flow. The equation for estimating this NO₃-N transport is

$$EN03 = \sum_{\ell=2}^M SEV_{\ell}^* (c_{NO3})_{\ell} \quad [2.140]$$

where EN03 is the amount of NO₃-N (kg/ha) moved from lower layers to the top layer by soil water evaporation E_s (mm), subscript ℓ refers to soil layers, and M is the number of layers contributing to soil water evaporation (maximum depth is 0.2 m).

Organic N Transport by Sediment

A loading function developed by McElroy et al. (1976) and modified by Williams and Hann (1978) for application to individual runoff events is used to estimate organic N loss. The loading function is

$$YON = 0.001 (Y) (c_{ON}) (ER) \quad [2.141]$$

where YON is the organic N runoff loss (kg/ha), Y is the sediment yield (t/ha), c_{ON} is the concentration of organic N in the top soil layer (g/t), and ER is the enrichment ratio. The enrichment ratio is the concentration of organic N in the sediment divided

by that in the soil. Enrichment ratios are logarithmically related to sediment concentration as described by Menzel (1980). An individual event enrichment-sediment concentration relationship was developed for EPIC considering upper and lower bounds. The upper bound of enrichment ratio is the inverse of the sediment delivery ratio. Exceeding the inverse of the delivery ratio implies that more organic N leaves the watershed than is dislodged from the soil. The delivery ratio is estimated for each runoff event by using the equation

$$DR = \left(\frac{q_p^*}{r_{ep}} \right)^{0.56} \quad [2.142]$$

where DR is the sediment delivery ratio (sediment yield divided by gross sheet erosion), q_p^* is the peak runoff rate (mm/h), and r_{ep} is the peak rainfall excess rate (mm/h). Equation 2.142 is based on sediment yield estimated by using MUSLE (Williams 1975). The rainfall excess rate cannot be evaluated directly because the hydrology model predicts only the total daily runoff volume. An estimate of the rate can be obtained, however, using the equation

$$r_{ep} = r_p - f \quad [2.143]$$

where r_p is the peak rainfall rate (mm/h) and f is the average infiltration rate (mm/h). The average infiltration rate can be computed from the equation

$$f = \frac{R - Q}{DUR} \quad [2.144]$$

where DUR is the rainfall duration (h). The rainfall duration can be estimated by solving equations 2.102 and 2.103 for t when $R_t/R=0.99$. Thus,

$$DUR = \frac{4.605 R}{r_p} \quad [2.145]$$

The lower limit of enrichment ratio is 1.0--sediment particle size distribution is the same as that of the soil. Thus, $1 \leq ER \leq 1/DR$. The logarithmic equation for estimating enrichment ratio is

$$ER = x_1 c_s^{x_2} \quad [2.146]$$

where c_s is the sediment concentration (g/m^3) and x_1 and x_2 are parameters set by the upper and lower limits. For the enrichment ratio to approach 1.0, the sediment concentration must be extremely high. Conversely, for the enrichment ratio to approach $1/\text{DR}$, the sediment concentration must be low. The simultaneous solution of equation 2.146 at the boundaries assuming that sediment concentrations range from 500 to $250,000 \text{ g}/\text{m}^3$ gives

$$x_2 = -\log\left(\frac{1}{\text{DR}}\right) / 2.699 \quad [2.147]$$

$$x_1 = \frac{1}{(0.25)^{x_2}} \quad [2.148]$$

Dentrification

As one of the microbial processes, denitrification is a function of temperature and water content. The equation used to estimate the denitrification rate is

$$\text{DN}_\ell = \text{WN03}_\ell \left(1 - \exp[(-1.4) (\text{TF}_{\text{N}\ell}) (C_\ell)] \right), \quad \text{SWF} \geq 0.9 \quad [2.149]$$

$$\text{DN} = 0. , \quad \text{SWF} < 0.9$$

DN is the denitrification rate in layer ℓ ($\text{kg}/\text{ha}/\text{d}$), TF_n is the nutrient cycling temperature factor, C is the organic carbon content (%), and SWF is the soil water factor. The temperature factor is expressed by the equation

$$\text{TF}_{\text{N}\ell} = \frac{T_\ell}{T_\ell + \exp(9.93 - 0.312 T_\ell)}, \quad T_\ell > 0. \quad [2.150]$$

$$\text{TF}_{\text{N}\ell} = 0., \quad T_\ell \leq 0.$$

where T is soil temperature ($^\circ\text{C}$) and subscript ℓ refers to the layers. The soil water factor considers total soil water in the equation

$$\text{SWF}_\ell = \frac{\text{SW}_\ell}{\text{P0}_\ell} \quad [2.151]$$

where SW is the soil water content in layer ℓ and P0 is the soil porosity (mm).

Mineralization

The N mineralization model is a modification of the PAPRAN mineralization model (Seligman and van Keulen 1981). The model considers two sources of mineralization: fresh organic N pool, associated with crop residue and microbial biomass, and the stable organic N pool, associated with the soil humus. Mineralization from the fresh organic N pool is estimated with the equation

$$RMN_{\ell} = (DCR_{\ell}) (FON_{\ell}) \quad [2.152]$$

where RMN is the N mineralization rate (kg/ha/d) for fresh organic N in layer ℓ , DCR is the decay rate constant for the fresh organic N, and FON is the amount of fresh organic N present (kg/ha). The decay rate constant is a function of C:N ratio, C:P ratio, composition of crop residue, temperature, and soil water:

$$DCR_{\ell} = (CNP_{\ell}) (RC) \left(\frac{SW_{\ell}}{FC_{\ell}} \right) \cdot (TF_{N\ell})^{0.5} \quad [2.153]$$

where CNP is a C:N and C:P ratio factor, RC is a residue composition factor, and FC is the soil water content (mm) at field capacity. The value of CNP is calculated with the equation

$$CNP_{\ell} = \min \begin{cases} \exp[-0.693 (CNR - 25) / 25] \\ \exp[-0.693 (CPR_{\ell} - 200) / 200] \\ 1.0 \end{cases} \quad [2.154]$$

where CNR is the C:N ratio and CPR is the C:P ratio in layer ℓ . The C:N and C:P ratios of crop residue are computed for each soil layer with the equations

$$CNR_{\ell} = \frac{0.58 FR_{\ell}}{FON_{\ell} + WN03_{\ell}} \quad [2.155]$$

$$CPR_{\ell} = \frac{0.58 FR_{\ell}}{FOP_{\ell} + AP_{\ell}} \quad [2.156]$$

where FOP is the amount of fresh organic P in layer ℓ (kg/ha) and AP is the amount of labile P (kg/ha). The value of RC is determined by the stage of residue decomposition. The first 20% of the residue is decomposed by using RC=0.8 (a rate appropriate for carbohydrate-like material). Between 20 and 90%, RC=0.05 (cellulose-like material). The final 10% of the residue is decomposed at a rate appropriate for lignin (RC=0.0095).

Organic N associated with humus is divided into two pools--active and stable--by using the equation

$$ON_{a\ell} = (RTN_{\ell}) (ON_{\ell}) \quad [2.157]$$

where ON_a is the active or readily mineralizable pool (kg/ha), RTN is the active pool fraction, ON is the total organic N (kg/ha), and the subscript ℓ is the soil layer number. The active pool fraction in the plow layer depends on the number of years the soil has been cultivated and is estimated with the equation

$$RTN_{\ell} = 0.4 \exp(-0.0277 YC) + 0.1 \quad [2.158]$$

where YC is period of cultivation before the simulation starts (yr). The concepts expressed in equation 2.158 are based on work of Hobbs and Thompson (1971). Below the plow layer the active pool fraction is set to 40% of the plow layer value, based on work of Cassman and Munns (1980). Organic N flux between the active and stable pools is governed by the equilibrium equation

$$RON_{\ell} = BKN \left(ON_{a\ell} \left(\frac{1}{RTN_{\ell}} \right) - ON_{s\ell} \right) \quad [2.159]$$

where RON is the flow rate (kg/ha/d) between the active and stable organic N pools, BKN is the rate constant ($\approx 1 \times 10^{-5}$) (d^{-1}), ON_s is the stable organic N pool, and subscript P is the soil layer number. The daily flow of humus related organic N (RON) is added to the stable pool and subtracted from the active pool.

Only the active pool of organic N is subjected to mineralization. The humus mineralization equation is

$$HMN_{\ell} = (CMN) (ON_{a\ell}) (SWF_{\ell} \cdot TF_{N\ell})^{0.5} (BD_{\ell})^2 / (BDP_{\ell})^2 \quad [2.160]$$

where HMN is the mineralization rate (kg/ha/d) for the active organic N pool in layer ℓ , CMN is the humus rate constant (≈ 0.0003) (d^{-1}), BD is the settled bulk density of the soil (t/m^3), and BDP is the current bulk density as affected by tillage (t/m^3). To maintain the N balance at the end of a day, the humus mineralization is subtracted from the active organic N pool; the residue mineralization is subtracted from the FON pool; 20% of RMN is added to the active ON pool; and 80% of RMN is added to $WNO3$ pool.

Immobilization

Like the mineralization model, the immobilization model is a modification of the PAPRAN model. Immobilization is a very important process in EPIC because it determines the residue decomposition rate. Of course, residue decomposition has an important effect on erosion. The daily amount of immobilization is computed by subtracting the amount of N contained in the crop residue from the amount assimilated by the microorganisms:

$$WIM_{\ell} = (DCR_{\ell}) (FR_{\ell}) (0.016 - c_{NFR}) \quad [2.161]$$

where WIM is the N immobilization rate in layer ℓ (kg/ha/d); 0.016 is the result of assuming that $C=0.4$ FR, that C:N of the microbial biomass and their labile products = 10, and that 0.4 of C in the residue is assimilated; and c_{NFR} is the N concentration in the crop residue (g/g). Immobilization may be limited by N or P availability. If the amount of N available is less than the amount of immobilization predicted from equation 2.161, the decay rate constant is adjusted with the relationship

$$DCR'_{\ell} = \frac{0.95 \text{ WN03}_{\ell}}{FR_{\ell} (0.016 - c_{NFR})} \quad [2.162]$$

where DCR' allows 95% use of the available $\text{NO}_3\text{-N}$ in soil layer ℓ . A similar adjustment is made if P is limiting. The crop residue is reduced by using the equation

$$FR_{\ell} = FR_{o\ell} - (DCR'_{\ell}) (FR_{o\ell}) \quad [2.163]$$

where FR_o and FR are the amounts of residue in soil layer ℓ at the start and end of a day (kg/ha). Finally, the immobilized N is added to the FON pool and subtracted from the WN03 pool.

Rainfall

To estimate the N contribution from rainfall, EPIC uses an average rainfall N concentration for a location for all storms. The amount of N in rainfall is estimated as the product of rainfall amount and concentration.

Phosphorus

Soluble P Loss in Surface Runoff

The EPIC approach is based on the concept of partitioning pesticides into the solution and sediment phases as described by Leonard and Wauchope (Knisel 1980). Because P is mostly associated with the sediment phase, the soluble P runoff equation can be expressed in the simple form

$$YSP = 0.01 (c_{LP\ell}) (Q) / k_d \quad [2.164]$$

where YSP is the soluble P (kg/ha) lost in runoff volume Q (mm), $c_{LP\ell}$ is the concentration of AP in soil layer ℓ (g/t), and k_d is the P concentration of the sediment divided by that of the water (m^3/t). The value of k_d used in EPIC is 175.

P Transport by Sediment

Sediment transport of P is simulated with a loading function as described in organic N transport. The P loading function is

$$YP = 0.001 (Y) (c_p) (ER) \quad [2.165]$$

where YP is the sediment phase P lost in runoff (kg/ha) and c_p is the concentration of P in the top soil layer (g/t).

Mineralization

The P mineralization model developed by Jones et al. (1984) is similar in structure to the N mineralization model.

Mineralization from the fresh organic P pool is estimated for each soil layer with the equation

$$RMP_\ell = (DCR_\ell) (FOP_\ell) \quad [2.166]$$

where RMP is the mineralization rate of fresh organic P in layer ℓ (kg/ha/d) and FOP is the fresh organic P in crop residue (kg/ha). Mineralization of organic P associated with humus is estimated for each soil layer by using the equation

$$HMP_\ell = \frac{(CMN) (ON_{a\ell}) (OP_\ell) (SWF_\ell \cdot TF_{N\ell})^{0.5} (BD_\ell)^2}{(ON_\ell) (BDP_\ell)^2} \quad [2.167]$$

where HMP is the humus P mineralization rate (kg/ha/d) and OP is the organic P content of soil layer ℓ (kg/ha). The rate of ON_a conversion to ON is used in equation 2.167 to calculate the active portion of the OP pool. This eliminates the need for maintaining two OP pools corresponding to the ON_a and ON_s pools.

To maintain the P balance at the end of a day, humus mineralization is subtracted from the organic P pool; residue mineralization is subtracted from the FOP pool; 20% of RMP is added to the OP pool; and 80% of RMP is added to labile P pool.

Immobilization

The P immobilization model, also developed by Jones et al. (1984), is similar in structure to the N immobilization model. The daily amount of immobilization is computed by subtracting the amount of P contained in the crop residue from the amount assimilated by the microorganisms:

$$WIP_{\ell} = (DCR'_{\ell}) (FR_{\ell}) (0.16 LF_{I\ell} - c_{PFR}) \quad [2.168]$$

where WIP is the P immobilization rate in layer ℓ (kg/ha/d); 0.16 is the result of assuming that C=0.4 FR and that 0.4 of the C in FR is assimilated by soil microorganisms; LF_I is the labile P immobilization factor allowing the P:C ratio of soil microorganisms to range from 0.01 to 0.02 as a function of labile P concentration, and c_{PFR} is the P concentration in the crop residue. The labile P immobilization factor is computed with the equations

$$LF_{I\ell} = 0.01 + 0.001 c_{LP\ell} , \quad c_{LP\ell} \leq 10 \quad [2.169]$$

$$LF_{I\ell} = 0.02 , \quad c_{LP\ell} > 10 \quad [2.170]$$

The immobilized P is added to the FOP pool and subtracted from the labile P pool.

Mineral P Cycling

The mineral P model was developed by Jones et al. (1984). Mineral P is transferred among three pools: labile, active mineral, and stable mineral. Fertilizer P is labile (available for plant use) at application but may be quickly transferred to the active mineral pool. Flow between the labile and active mineral pools is governed by the equilibrium equation

$$MPR_{\ell} = 0.1 SWF_{\ell} \exp(0.115 T_{\ell} - 2.88) \left(AP_{\ell} - MP_{a\ell} \left(\frac{PSP_{\ell}}{1 - PSP_{\ell}} \right) \right) \quad \dots [2.171]$$

where MPR is the mineral P flow rate for layer ℓ (kg/ha/d), T is the soil temperature ($^{\circ}C$), MP_a is the amount in the active mineral P pool (kg/ha), and PSP is the P sorption coefficient defined as the fraction of fertilizer P remaining in the labile pool after the initial rapid phase of P sorption is complete. The daily amount of P computed with equation 2.171 flows to the active mineral P pool and is, therefore, added to that pool and subtracted from the labile pool. Obviously, the flow reverses when labile P is less than $MP_{a\ell} PSP_{\ell} / (1 - PSP_{\ell})$. The P sorption

coefficient is a function of chemical and physical soil properties as described by the following equations (Jones et al. 1984).

In calcareous soils

$$\text{PSP}_\ell = 0.58 - 0.0061 \text{CAC}_\ell \quad [2.172]$$

In noncalcareous, slightly weathered soils

$$\text{PSP}_\ell = 0.02 + 0.0104 \text{AP}_\ell \quad [2.173]$$

In noncalcareous, moderately weathered soils

$$\text{PSP}_\ell = 0.0054 \text{BSA}_\ell + 0.116 \text{PH}_\ell - 0.73 \quad [2.174]$$

In noncalcareous, highly weathered soils

$$\text{PSP}_\ell = 0.46 - 0.0916 \ln \text{CLA}_\ell \quad [2.175]$$

where PSP is the P sorption coefficient for soil layer ℓ , CAC is the CaCO_3 concentration (g/t), and BSA is the base saturation by the ammonium acetate (NH_4OAc) method (%). PSP is constrained within the limits $0.05 \leq \text{PSP} \leq 0.75$. At equilibrium the stable P pool is assumed to be four times as large as the active mineral P pool. Flow between the P pools is governed by the equation

$$\text{ASPR}_\ell = \omega_\ell (4 \text{MP}_{al} - \text{MP}_{sl}) \quad [2.176]$$

where ASPR is the flow rate between the active and stable mineral P pools (kg/ha/d) for soil layer ℓ , ω is the flow coefficient (d^{-1}), and MP_s is the amount of stable mineral P (kg/ha). The daily amount of P computed with equation 2.176 flows into the stable pool and is subtracted from the active pool. Obviously, the flow reverses when $\text{MP}_{sl} > 4\text{MP}_{al}$. The flow coefficient, ω , is a function of PSP as expressed by the equations (Jones et al. 1984)

$$\omega_\ell = \exp(-1.77 \text{PSP}_\ell - 7.05) \quad [2.177]$$

for noncalcareous soils, and

$$\omega_\ell = 0.0076 \quad [2.178]$$

for calcareous soils.

Soil Temperature

Daily average soil temperature at the center of each soil layer is simulated for use in nutrient cycling and hydrology. The basic soil temperature equation is

$$T_{\ell,i} = \text{LAG}(T_{\ell,i-1}) + (1.0 - \text{LAG}) (Z_{\ell} (\bar{T} + \text{TG}_i) + \text{TG}_i) \quad [2.179]$$

where T is the soil temperature at the center of layer ℓ on day i ($^{\circ}\text{C}$), LAG is a coefficient ranging from 0.0 to 1.0 that allows proper weighting of yesterday's temperature, \bar{T} is the long-term average annual air temperature at the site, TG is the soil surface temperature, and FZ is a depth factor. Thus, given yesterday's temperature, equation 2.179 estimates today's temperature as a function of soil surface temperature, depth, and a lag coefficient. It is assumed that the temperature remains almost constant at some depth called damping depth and is approximately \bar{T} . The depth weighting factor governs temperature changes between the soil surface and the damping depth according to the equation

$$\text{FZ}_{\ell} = \frac{\text{ZD}}{\text{ZD} + \exp(-0.867 - 2.08 \text{ZD})} \quad [2.180]$$

where

$$\text{ZD} = \frac{Z_{\ell} + Z_{\ell-1}}{2.0 \text{DD}} \quad [2.181]$$

where Z is soil depth from the surface (m) and DD is the damping depth (m). Obviously, equations 2.180 and 2.181 make near surface temperatures a strong function of TG . As depth increases, \bar{T} has more influence until finally at the damping depth, the temperature is within 5% of \bar{T} .

The damping depth is a function of soil bulk density and water content as expressed in the equation

$$\text{DP} = 1.0 + \frac{2.5 \text{BD}}{\text{BD} + \exp(6.53 - 5.63 \text{BD})} \quad [2.182]$$

$$\S = \frac{\text{SW}}{(0.356 - 0.144 \text{BD}) Z_{\text{M}}} \quad [2.183]$$

$$\text{DD} = \text{DP} \exp \left(\ln \left(\frac{0.5}{\text{DP}} \right) \left(\frac{1 - \S}{1 + \S} \right)^2 \right) \quad [2.184]$$

where DP is the maximum damping depth for the soil (m), BD is the soil bulk density (t/m³), Z_M is the distance from the bottom of the lowest soil layer to the surface, and § is a scaling parameter.

To complete the solution of equation 2.179, the soil surface temperature must be estimated. The first step is to estimate the bare soil surface temperature (TGB). Of course, TGB is usually closely related to the air temperature. Other important factors that also influence TGB are precipitation and previous soil temperature. When precipitation occurs, the soil surface temperature usually decreases. Thus, the appropriate air temperature for estimating TGB is near the daily minimum.

$$TGBW_i = T_{mn,i} + \Omega_s (T_{mx,i} - T_{mn,i}) \quad [2.185]$$

where TGBW is the bare soil surface temperature on wet day, i, and Ω_s is a scaling factor to adjust for wet days. The value of Ω_s ranges from 0.0 to 1.0, but more realistic results can be obtained using $\Omega_s \approx 0.1$. The companion equation for dry days is derived from the continuity equation (equation 2.79).

$$TGBD_i = \frac{\frac{T_{mx,i} + T_{mn,i}}{2} - \left(\frac{NWD_k}{ND_k}\right) [T_{mn,i} + \Omega_s (T_{mx,i} - T_{mn,i})]}{1.0 - \frac{NWD_k}{ND_k}} \quad \dots [2.186]$$

where TGBD is the bare soil surface temperature on dry day, i, NWD is the number of wet days, and ND is the number of days in month k.

To estimate the lag in the system caused by heat stored in the soil, a 5-day moving average is applied to TGB.

$$TGB_i^* = \sum_{N=0}^4 TGB_{i-n} \quad [2.187]$$

where TGB* is the final estimate of bare soil surface temperature (°C) and TGB is either TGBW or TGBD obtained from equations 2.185 and 2.186.

If the soil surface is not bare, the surface temperature can be affected considerably by the amount of cover (crop residue or snow). This effect can be simulated by lagging the predicted bare surface temperature according to the equation

$$TG_i = (bcv) (TGB^*_{i-1}) + (1 - bcv) (TGB^*_i) \quad [2.188]$$

where TG is the final estimate of soil surface temperature ($^{\circ}C$) and bcv is a lagging factor for simulating residue and snow cover effects on surface temperature. The value of bcv is 0 for bare soil and approaches 1.0 as cover increases, as expressed in the equation

$$bcv = \max \left\{ \begin{array}{l} \frac{CV}{CV + \exp(7.563 - 1.297 \times 10^{-4} CV)} \\ \frac{SNO}{SNO + \exp(2.303 - 0.2197 SNO)} \end{array} \right. \quad [2.189]$$

where CV is the sum of above ground biomass and crop residue (t/ha) and SNO is the water content of the snow cover (mm).

Crop Growth Model

A single model is used in EPIC for simulating all the crops considered (Corn, Grain sorghum, Wheat, Barley, Oats, Sunflower, Soybean, Alfalfa, Cotton, Peanuts, Potatoes, Durham wheat, Winter peas, Faba beans, Rapeseed, Sugarcane, Sorghum hay, Range grass, Rice, Casava, Lentils, and Pine trees). Of course, each crop has unique values for the model parameters. EPIC is capable of simulating growth for both annual and perennial crops. Annual crops grow from planting date to harvest date or until the accumulated heat units equal the potential heat units for the crop. Perennial crops maintain their root systems throughout the year, although they may become dormant after frost. They start growing when the average daily air temperature exceeds their base temperature.

Phenological development of the crop is based on daily heat unit accumulation. It is computed by using the equation

$$HU_k = \left(\frac{T_{mx,k} + T_{mn,k}}{2} \right) - T_{b,j} , \quad HU_k \geq 0 \quad [2.190]$$

where HU, T_{mx} , and T_{mn} are the values of heat units, maximum temperature, and minimum temperature ($^{\circ}\text{C}$) on day k, and T_b is the crop-specific base temperature ($^{\circ}\text{C}$) (no growth occurs at or below T_b) of crop j. A heat unit index (HUI) ranging from 0 at planting to 1 at physiological maturity is computed as follows:

$$\text{HUI}_i = \frac{\left(\sum_{k=1}^i \text{HU}_k \right)}{\text{PHU}_j} \quad [2.191]$$

where HUI is the heat unit index for day i and PHU is the potential heat units required for the maturation of crop j. The value of PHU may be inputted or calculated by the model from normal planting at harvest dates. Date of harvest, leaf area growth and senescence, optimum plant nutrient concentrations, and partition of dry matter among roots, shoots, and economic yield are affected by HUI.

Potential Growth

Interception of solar radiation is estimated with a Beer's law equation (Monsi and Saeki 1953)

$$\text{PAR}_i = 0.5 (\text{RA})_i [1. - \exp(-0.65 \text{LAI})]_i \quad [2.192]$$

where PAR is photosynthetic active radiation (MJ/m^2), RA is solar radiation (MJ/m^2), LAI is the leaf area index, and subscript i is the day of the year. Using Monteith's approach (Monteith 1977), potential increase in biomass for a day can be estimated with the equation

$$\Delta B_{p,i} = 0.001 (\text{BE})_j (\text{PAR})_i (1 + \Delta \text{HRLT}_i)^3 \quad [2.193]$$

where ΔB_p is the daily potential increase in biomass (t/ha), BE is the crop parameter for converting energy to biomass (kg/MJ), HRLT is the day length (h), and ΔHRLT is the change in day length (h/d). The day length function of equation 2.193 increases potential growth during the spring and decreases it in the fall (Baker et al. 1980).

Day length is a function of the time of year and latitude as expressed in the equation

$$\text{HRLT}_i = 7.64 \cos^{-1} \left(-\tan\left(\frac{2\pi}{365} \text{LAT}\right) \tan(\text{SD})_i \right) \quad [2.194]$$

where LAT is the latitude of the watershed (degrees) and SD, the sun's declination angle, is defined by the equation

$$SD_i = 0.4102 \sin \left[\frac{2\pi}{365} (i - 80.25) \right] \quad [2.195]$$

In most crops, leaf area index (LAI) is initially zero or very small. It increases exponentially during early vegetative growth, when the rates of leaf primordia development, leaf tip appearance, and blade expansion are linear functions of heat unit accumulation (Tollenaar et al. 1979; Watts 1972). In vegetative crops such as sugarcane and some forages, LAI reaches a plateau, at which time the rates of senescence and growth of leaf area are approximately equal. In many crops, LAI decreases after reaching a maximum and approaches zero at physiological maturity. In addition, leaf expansion, final LAI, and leaf duration are reduced by stresses (Acevedo et al. 1971; Eik and Hanway 1965).

LAI is simulated as a function of heat units, crop stress, and crop development stages. From emergence to the start of leaf decline, LAI is estimated with the equations

$$LAI_i = LAI_{i-1} + \Delta LAI \quad [2.196]$$

$$\Delta LAI = (\Delta HUF) (LAI_{mx}) \left(1 - \exp[5.0(LAI_{i-1} - LAI_{mx})] \right) \sqrt{REG_i} \quad \dots [2.197]$$

where LAI is leaf area index, HUF is the heat unit factor, and REG is the value of the minimum crop stress factor. Subscript mx is the maximum value and Δ is the daily change. The heat unit factor is computed by using the equation

$$HUF_i = \frac{HUI_i}{HUI_i + \exp[ah_{j,1} - (ah_{j,2}) (HUI_i)]} \quad [2.198]$$

where $ah_{j,1}$ and $ah_{j,2}$ are parameters of crop j, and HUI is the heat unit index.

From the start of leaf decline to the end of the growing season, LAI is estimated with the equation

$$LAI_i = LAI_0 \left(\frac{1 - HUI_i}{1 - HUI_0} \right)^{adj} \quad [2.199]$$

where ad is a parameter that governs LAI decline rate for crop j and subscript o is the day of the year when LAI starts declining.

Crop height is estimated with the relationship

$$CHT_i = HMX_j \sqrt{HUF_i} \quad [2.200]$$

where CHT is the crop height (m) and HMX is the maximum height for crop j .

The fraction of total biomass partitioned to the root system normally decreases from 0.3 to 0.5 in the seedling to 0.05 to 0.20 at maturity (Jones 1985). The model simulates this partitioning by decreasing the fraction linearly from 0.4 at emergence to 0.2 at maturity. Thus, the potential daily change in root weight is computed with the equation

$$\Delta RWT_i = \Delta B_{p,i} (0.4 - 0.2 HUI_i) \quad [2.201]$$

where ΔRWT is the change in root weight (t/ha) on day i . The potential change in root weight through the root zone is simulated as a function of plant water use in each layer of soil with the equation

$$\Delta RW_{i,\ell} = (\Delta RWT_i) \left(\frac{u_{i,\ell}}{\sum_{\ell=1}^M u_{i,\ell}} \right) \quad [2.202]$$

where RW is the root weight in soil layer ℓ (t/ha), M is the total number of soil layers, and u is the daily water use rate in layer ℓ (mm/d).

Rooting depth normally increases rapidly from the seeding depth to a crop-specific maximum. In many crops, the maximum is usually attained well before physiological maturity (Borg and Grimes 1986). Rooting depth is simulated as a function of heat units and potential root zone depth:

$$\Delta RD_i = 2.5 (RDMX_j) (\Delta HUF_i), \quad RD_i \leq RZ_j \quad [2.203]$$

where RD is the root depth (m), $RDMX$ is the maximum root depth (m) for crop j in ideal soil, and RZ is the soil profile depth (m).

The economic yield of most grain, pulse, and tuber crops is a reproductive organ. Crops have a variety of mechanisms which ensure that their production is neither too great to be supported

by the vegetative components nor too small to ensure survival of the species. As a result, harvest index (economic yield/above-ground biomass) is often a relatively stable value across a range of environmental conditions. In EPIC, crop yield is estimated by using the harvest index concept:

$$YLD_j = (HI_j) (B_{AG}) \quad [2.204]$$

where YLD is the amount of the crop removed from the field (t/ha), HI is the harvest index, and B_{AG} is the above-ground biomass (t/ha) for crop j. Harvest index increases nonlinearly from 0 at planting to 1.0 at maturity according to the equation

$$HIA_i = HI_j \left(\frac{i}{\sum_{k=1}^i \Delta HUFH_k} \right) \quad [2.205]$$

where HIA is the harvest index on day i and HUFH is the heat unit factor that affects harvest index.

The harvest index heat unit is computed with the equation

$$HUFH_i = \frac{HUI_i}{HUI_i + \exp(6.50 - 10.0 HUI_i)} \quad [2.206]$$

The constants in equation 2.206 are set to allow $HUFH_i$ to increase from 0.1 at $HUI_i=0.5$ to 0.92 at $HUI_i=0.9$. This is consistent with the economic yield development of grain crops, which produce the greatest economic yield in the second half of the growing season.

Water Use

The potential water use, E_p , is estimated as a fraction of the potential evaporation by using the leaf-area-index relationship developed by Ritchie (1972).

$$E_{Pi} = E_{Oi} \left(\frac{LAI_i}{3} \right), \quad E_{Pi} \leq E_{Oi} \quad [2.207]$$

where E_o is the potential evaporation and LAI is the leaf area index on day i.

The potential water use from the soil surface to any root depth is estimated with the function

$$U_{Pi} = \frac{E_{Pi}}{1. - \exp(-\Lambda)} \left(1. - \exp\left[-\Lambda \left(\frac{Z}{RZ}\right)\right] \right) \quad [2.208]$$

where U_p is the total water use rate (mm/d) to depth Z (m) on day i , RZ is the root zone depth (m), and Λ is a water use distribution parameter. The amount used in a particular layer can be calculated by taking the difference between U_{Pi} values at the layer boundaries:

$$u_{P\ell} = \frac{E_{Pi}}{1. - \exp(-\Lambda)} \left[\left(1. - \exp\left[-\Lambda \left(\frac{Z_\ell}{RZ}\right)\right] \right) - \left(1. - \exp\left[-\Lambda \left(\frac{Z_{\ell-1}}{RZ}\right)\right] \right) \right] \dots [2.209]$$

where $u_{P\ell}$ is the potential water use rate from layer ℓ (mm/d).

Equation 2.209 applies to a soil that provides poor conditions for root development when Λ is set to a high value like 10. The high Λ value gives high water use near the surface and very low use in the lower half of the root zone. Since there is no provision for water deficiency compensation in any layer, considerable water stress may be incorrectly indicated if equation 2.209 is used. To overcome this problem, equation 2.209 was modified to allow plants to compensate for water deficiency in a layer by using more water from other layers. Total compensation can be accomplished by taking the difference between U_{Pi} at the bottom of a layer and the sum of water use above a layer:

$$u_{P\ell} = \frac{E_{Pi}}{1. - \exp(-\Lambda)} \left(1. - \exp\left[-\Lambda \left(\frac{Z_\ell}{RZ}\right) \right] \right) - \sum_{K=1}^{\ell-1} u_k \quad [2.210]$$

where u_k is the actual water use rate (mm/d) for all layers above layer ℓ . Thus, any deficit can be overcome if a layer that is encountered has adequate water storage. Neither equation 2.209 (no compensation) nor equation 2.210 (total compensation) is satisfactory to simulate a wide range of soil conditions. A combination of the two equations, however, provides a very general water use function:

$$u_{P\ell} = \frac{E_{Pi}}{1. - \exp(-\Lambda)}$$

$$\left(1. - \exp\left[-\Lambda \left(\frac{Z_\ell}{RZ}\right)\right] - (1. - UC) \left(1. - \exp\left[-\Lambda \left(\frac{Z_{\ell-1}}{RZ}\right)\right] \right) \right) - UC \sum_{k=1}^{\ell-1} u_k$$

..... [2.211]

where UC varies over a range (0.-1.) and is the water deficit compensation factor. In soils with a good rooting environment, UC=1. gives total compensation. The other extreme, poor conditions, allow no compensation (UC=0.). The procedure for estimating UC is described in the Growth Constraints section of this chapter.

The potential water use in each layer calculated with equation 2.211 is reduced when the soil water storage is less than 25% of plant-available soil water (Jones and Kiniry 1986) by using the equation

$$u_\ell = u_{p\ell} \exp \left(5. \left(\frac{4. (SW_{\ell i} - WP_\ell)}{(FC_\ell - WP_\ell)} - 1. \right) \right), \quad SW_\ell < \frac{FC_\ell - WP_\ell}{4} + WP_\ell$$

..... [2.212]

$$u_\ell = u_{p\ell}, \quad SW_\ell \geq \frac{FC_\ell - WP_\ell}{4} + WP_\ell \quad [2.213]$$

where SW is the soil water content in layer ℓ on day i (mm) and FC and WP are the soil water contents at field capacity and wilting point for layer ℓ .

Nutrient Uptake

Nitrogen

Supply and Demand. Crop use of N is estimated by using a supply and demand approach. The daily crop N demand is the difference between the crop N content and the ideal N content for that day. The demand is estimated with the equation

$$UND_i = (c_{NB})_i (B)_i - \sum_{k=1}^{i-1} UN_k \quad [2.214]$$

where UND is the N demand rate of the crop (kg/ha/d), c_{NB} is the optimal N concentration of the crop (kg/t), B is the accumulated biomass (t/ha) for day i , and UN is the actual N uptake rate (kg/ha/d). The optimal crop N concentration declines with increasing growth stage (Jones 1983a) and is computed as a function of growth stage by using the equation

$$c_{NB_i} = bn_1 + bn_2 \exp(-bn_3 HUI_i) \quad [2.215]$$

where bn_1 , bn_2 , and bn_3 are crop parameters expressing N concentration and HUI (heat unit index) is the fraction of the growing season.

Soil supply of N is assumed to be limited by mass flow of NO_3 -N to the roots

$$UN_{\ell,i} = u_{\ell,i} \left(\frac{WN03_{\ell}}{SW_{\ell}} \right)_i \quad [2.216]$$

where UN is the rate of N supplied by the soil (kg/ha/d), $WN03$ is the amount of NO_3 -N (kg/ha), SW is the soil water content (mm), u is water use rate (mm/d), and subscript ℓ refers to the soil layers. The total mass flow demand is estimated by summing the layer demands:

$$UNS_i = \sum_{\ell=1}^M UN_{\ell,i} \quad [2.217]$$

where UNS is the N supply rate from soil to plants (kg/ha/d). Since mass flow uptake can produce questionable results when N concentrations are extremely high or low, UN values obtained from equation 2.216 are adjusted:

$$UNa_{\ell,i} = UN_{\ell,i} \left(\frac{UND_i}{UNS_i} \right), \quad UNa_{\ell,i} \leq WN03_{\ell,i} \quad [2.218]$$

Equation 2.218 assures that actual N uptake cannot exceed the plant demand when mass flow estimates are too large. It also provides for increased N supply when mass flow estimates are too low despite the availability of NO_3 .

Fixation. Daily N fixation is estimated as a fraction of daily plant N uptake for legumes:

$$WFX_i = FXR_i \cdot UN_i, \quad WFX \leq 6.0 \quad [2.219]$$

where WFX is the amount of N fixation (kg/ha) and FXR is the fraction of uptake for day i. The fraction, FXR, is estimated as a function of soil NO₃ and soil water contents and plant growth stage:

$$FXR = \min(1.0, FXW, FXN) \cdot FXG \quad [2.220]$$

where FXG is the growth stage factor, FXW is the soil water content factor, and FXN is the soil NO₃ content factor. The growth stage factor is computed with the equations

$$FXG_i = 0.0, \quad HUI_i \leq 0.15, \quad HUI_i \geq 0.75 \quad [2.221]$$

$$FXG_i = 6.67 HUI_i - 1.0 \quad 0.15 < HUI_i \leq 0.3 \quad [2.222]$$

$$FXG_i = 1.0 \quad 0.3 < HUI_i < 0.55 \quad [2.223]$$

$$FXG_i = 3.75 - 5.0 HUI_i \quad 0.55 < HUI_i < 0.75 \quad [2.224]$$

where HUI is the heat unit index for day i. The soil water content factor reduces N fixation when the water content in the top 0.3 m is less than 85% of field capacity according to the equation

$$FXW_i = \frac{SW3_i - WP3}{0.85 (FC3 - WP3)}, \quad SW3 < 0.85(FC3 - WP3) + WP3 \quad [2.225]$$

where SW3, WP3, and FC3 are the water contents in the top 0.3 m of soil on day i, at wilting point, and at field capacity.

The amount of NO₃ in the root zone determines the soil NO₃ factor, FXN:

$$FXN = 0. , \quad WN03 > 300. \text{ kg/ha/m} \quad [2.226]$$

$$FXN = 1.5 - 0.005 \left(\frac{WN03}{RD} \right), \quad 100 < WN03 \leq 300. \quad [2.227]$$

$$FXN = 1.0 , \quad WN03 \leq 100. \text{ kg/ha/m} \quad [2.228]$$

where WN03 is the weight of NO₃ in the root zone (kg/ha) and RD is the root depth (m).

Phosphorus

Crop use of P is estimated by the supply and demand approach described in the N model. The daily plant demand is computed with equation 2.214 written in the form

$$UPD_i = (c_{PB})_i (B)_i - \sum_{k=1}^{i-1} UP_k \quad [2.229]$$

where UPD is the P demand rate for the plant (kg/ha/d), c_{PB} is the optimal P concentration for the plant, and UP is the actual P uptake rate (kg/ha/d). The optimal plant P concentration is computed with equation 2.215 written in the form

$$c_{PB_i} = bp_1 + bp_2 \exp(-bp_3 HUI_i) \quad [2.230]$$

where bp_1 , bp_2 , and bp_3 are crop parameters expressing P concentration. Soil supply of P is estimated by using the equation

$$UPS_i = 1.5 UPD_i \sum_{\ell=1}^M (LF_u)_\ell \left(\frac{RW_\ell}{RWT_i} \right) \quad [2.231]$$

where UPS is the rate of P supplied by the soil (kg/ha/d), LF_u is the labile P factor for uptake, RW is the root weight in layer ℓ (t/ha), and RWT is the total root weight on day i (t/ha). The constant 1.5 allows two-thirds of the roots to meet the P demand of the plant if labile P is not limiting. The labile P factor for uptake ranges from 0.1 to 1.0 according to the equation

$$LF_{u\ell} = 0.1 + \frac{0.9 c_{LP\ell}}{c_{LP\ell} + 117. \exp(-0.283 c_{LP\ell})} \quad [2.232]$$

where c_{LP} is the labile P concentration in soil layer ℓ (g/t). Equation 2.232 allows optimum uptake rates when c_{LP} is higher than 20 g/t. This is consistent with critical labile P concentrations for a range of crops and soils (See Chapter 7). Sharpley et al. (1984, 1985) described methods of estimating c_{LP} from soil test P and other soil characteristics.

Growth Constraints

Usually the potential crop growth and yield are not achieved because of various constraints imposed by the plant environment.

The model estimates the severities of the stresses caused by water, nutrients, temperature, aeration, and radiation. The estimates (stress factors) range from 0.0 (the most severe) to 1.0, and the stresses affect plants in several ways. In EPIC, the stresses are considered in estimating constraints on biomass accumulation, root growth, and yield. The biomass constraint is calculated by using the lowest value from among the stress factors estimated for water, nutrients (N and P), temperature, and aeration. The root growth constraint is the minimum of the soil strength, temperature, and aluminum toxicity stresses. A description of the stress factors involved in determining each constraint follows.

Biomass

The potential biomass predicted with equation 2.193 is adjusted daily with the following equation if any one of five plant stress factors is less than 1.0:

$$\Delta B = (\Delta B_p) (REG) \quad [2.233]$$

where REG is the crop growth regulating factor (the lowest value from among the estimates for the stress factors).

Water Stress. The water stress factor is computed by considering supply and demand in the equation

$$WS_i = \frac{\sum_{\ell=1}^M u_{i,\ell}}{E_{pi}} \quad [2.234]$$

where WS is the water stress factor, u is the water use in layer ℓ , and E_p is the potential plant water evaporation rate on day i . This is consistent with the concept that drought stress limits biomass production in proportion to transpiration reduction (Hanks 1983).

Temperature Stress. The plant temperature stress factor is estimated with the equation

$$TS_i = \sin \left(\frac{\pi}{2} \left(\frac{T_G - T_{bj}}{T_{oj} - T_{bj}} \right) \right) \quad [2.235]$$

where TS is the plant temperature stress factor, T_G is the soil surface temperature ($^{\circ}C$), T_b is the base temperature for crop j , and T_o is the optimal temperature for crop j . Equation 2.235 produces symmetrical plant growth stress about the optimal temperature and considers average daily soil surface temperature as a stress indicator.

Nutrient Stress. The N and P stress factors are based on the ratio of accumulated plant N and P to the optimal values. The stress factors vary nonlinearly from 1.0 at optimal N and P levels to 0. when N or P is half the optimal level (Jones 1983a). For N, the scaling equation is

$$SN_{S,i} = 2 \left(1 - \frac{\sum_{k=1}^i UN_k}{(c_{NB})_i (B)_i} \right) \quad [2.236]$$

where SN_S is a scaling factor for the N stress factor, UN is the crop N uptake rate on day k (kg/ha/d), c_{NB} is the optimal N concentration of the crop on day i , and B is the accumulated biomass (t/ha). The N stress factor is computed with the equation

$$SN_i = 1 - \frac{SN_{S,i}}{SN_{S,i} + \exp(3.39 - 10.93 SN_{S,i})} \quad [2.237]$$

where SN is the N stress factor for day i . The P stress factor, SP , is computed with equations 2.236 and 2.237 written in P terms.

Aeration Stress. When soil water content approaches saturation, plants may suffer from aeration stress. The water content of the top 1 m of soil is considered in estimating the degree of stress:

$$SAT = \frac{SW1}{PO1} - CAF_j \quad [2.238]$$

$$AS_i = 1 - \frac{SAT}{SAT + \exp(-1.291 - 56.1 SAT)}, \quad SAT > 0.0 \quad [2.239]$$

where SAT is the saturation factor, $SW1$ is the water content of the top 1 m of soil (mm), $PO1$ is the porosity of the top 1 m of soil (mm), CAF is the critical aeration factor for crop j (≈ 0.85 for many crops), and AS is the aeration stress factor. Finally, the value of REG is determined as the lowest of the stress factors WS , TS , SN , SP , and AS .

Root Growth. As described in equation 2.202, root growth is proportional to water use. Water use from a soil layer is estimated as a function of soil depth, water content, and a compensation factor according to equations 2.211 and 2.212. Soil strength, temperature, and aluminum toxicity stress factors are calculated from soil properties. The lowest of these three

stress factors, which then becomes the root growth stress factor, constrains root growth by governing the water use compensation factor.

Cold soil temperatures may limit root growth, especially when subsoil layers warm slowly in the spring (Taylor 1983). The temperature stress for each soil layer is computed by substituting soil temperature at the center of the layer for soil surface temperature in equation 2.235.

Numerous studies have shown that root growth is affected by soil strength. Three important strength determinants are bulk density, texture, and water content (Eavis 1972; Monteith and Bonath 1965; Taylor et al. 1966). All three variables are considered in estimating the EPIC soil strength stress factor by using the following equations:

$$SS_{\ell} = 0.1 + \frac{0.9 BD_{\ell}}{BD_{\ell} + \exp[bt_1 + bt_2 (BD_{\ell})]} \quad [2.240]$$

where SS is the soil strength factor in layer ℓ , BD is the soil bulk density (t/m^3) adjusted for water content, and bt_1 and bt_2 are parameters dependent upon soil texture. The values of bt_1 and bt_2 are obtained from a simultaneous solution of equation 2.240 by substituting boundary conditions for stress. The lower boundary, where essentially no stress occurs, is given by the equation (Jones 1983b)

$$BDL = 1.15 + 0.00445 SAN \quad [2.241]$$

where BDL is the bulk density near the lower boundary ($SS=1.$) for a particular percentage of sand, SAN . The upper boundary is given by the equation (Jones 1983b)

$$BDU = 1.5 + 0.005 SAN \quad [2.242]$$

where BDU is the bulk density near the upper boundary ($SS \approx 0.2$) for a particular percentage of sand, SAN . The equations for estimating bt_1 and bt_2 are

$$bt_2 = \frac{\ln(0.112 BDL) - \ln(8. BDU)}{BDL - BDU} \quad [2.243]$$

$$bt_1 = \ln(0.0112 BDL) - (bt_2) (BDL) \quad [2.244]$$

Equations 2.243 and 2.244 assure that equation 2.240 gives SS values of 1.0 and 0.2 for $BD=BDL$ and $BD=BDU$.

The water-content-adjusted bulk density is estimated with Grossman's equation (Grossman et al. 1985)

$$BD_{\ell,i} = BD3 + (BDD - BD3) \left(\frac{FC_{\ell} - SW_{\ell,i}}{FC_{\ell} - WP_{\ell} (4.083 - 3.33 BDD^{1/3})} \right) \dots [2.245]$$

where BD is the water-content-adjusted bulk density of day i , $BD3$ is the bulk density at 33 kPa water content, BDD is the bulk density of the oven dry soil, FC is the field capacity, WP is the wilting point, and SW is the soil water content for layer ℓ on day i .

Aluminum (Al) toxicity can limit root growth in some acid soil layers, and Al saturation is a widely used index of its effects (Abruna et al. 1982; Brenes and Pearson 1973; Pavan et al. 1982). Because crops and cultivars differ in sensitivity to Al toxicity (Foy et al. 1974; Mugwira et al. 1980), EPIC expresses Al toxicity as a function of this sensitivity. The Al toxicity stress factor associated with root growth is estimated with the equations

$$ATS_{\ell} = \frac{1}{100 - ALO_j}, \quad ALS_{\ell} > ALO_j \quad [2.246]$$

$$ATS_{\ell} = 1.0, \quad ALS_{\ell} \leq ALO_j \quad [2.247]$$

where ATS is the Al toxicity stress factor (0-1) for soil layer ℓ , ALS is the Al saturation (%), and ALO is the maximum ALS value crop j can tolerate without stress (%). Crop specific values of ALO are determined from the equation

$$ALO_j = 10 + 20(ALT_j - 1) \quad [2.248]$$

where ALT_j is the Al tolerance index number for crop j . Values of ALT range from 1 to 5 (1 is sensitive; 5 is tolerant) for various crops. Finally, the root growth stress factor, RGF , is the lowest of the stress factors SS , ATS , and TS .

Water Use

Plant water use is governed by the root growth stress factor and the water deficit compensation factor of equation 2.211. Recall that the water deficit compensation factor, UC , allows total compensation if the value is 1.0 and no compensation at 0.0. The value of UC for any layer is estimated as the product of the root growth stress factors for the layer and all layers above:

$$UC_{\ell} = \prod_{k=1}^{\ell} RGF_k \quad [2.249]$$

Thus, a low RGF_k greatly reduces water compensation for layer k and all layers below k .

The final estimates of water use for each layer are obtained by multiplying the u_{ℓ} values in equations 2.212 and 2.213 by RGF :

$$u_{\ell}^* = (u_{\ell}) (RGF)_{\ell} \quad [2.250]$$

Crop Yield

Crop yield may be reduced through water-stress-induced reductions in the harvest index. Most grain crops are particularly sensitive to water stress from shortly before until shortly after anthesis, when major yield components are determined (Doorenbos and Kassam 1979). Optimum conditions for growth may reduce harvest index slightly if dry matter accumulation is large and economic yield is limited by sink size. The harvest index is affected by water stress according to the equation

$$HIA_i = HIA_{i-1} - HI_j \left(1 - \frac{1}{1 + (WSYF_j) (FHU_i) (0.9 - WS_i)} \right) \quad \dots [2.251]$$

where HIA is the adjusted harvest index, $WSYF$ is a crop parameter expressing drought sensitivity, FHU is a function of crop stage, and WS is the water stress factor for day i . Notice that harvest index may increase slightly on days with WS values greater than 0.9. The crop stage factor, FHU , is estimated with the equation

$$FHU_i = \sin \left(\frac{\pi}{2} \left(\frac{HUI_i - 0.3}{0.3} \right) \right), \quad 0.3 \leq HUI_i \leq 0.9 \quad [2.252]$$

$$FHU_i = 0., \quad HUI_i < 0.3 \text{ or } HUI_i > 0.9$$

Thus, water stress affects harvest index only between 0.3 and 0.9 of maturity, with the greatest effect occurring at 0.6.

Winter Dormancy

The day length growth constraint is used to simulate a winter dormant period for fall planted crops. This constraint is only imposed for areas that have a growing season of fewer than 12 months. A 12-month growing season is defined in the model as having no month with mean minimum temperature of lower than 5°C.

If there is a dormant winter period, it is defined as the time when day length is within 1 h of the location's minimum day length.

If a crop becomes dormant in winter, the heat unit summation (eq. 2.191) is set to zero. This provides for rapid new growth when temperatures increase in the spring. During the dormant period, the plants are not allowed to grow. The standing live biomass is actually reduced during this period because of frost and short day length. The day length reduction factor is estimated with the equation

$$FHR_i = 0.35 \left(1.0 - \frac{HRLT_i}{HRLT_{mn} + 1} \right) \quad [2.253]$$

where FHR is the day length reduction factor, $HRLT_i$ is the day length on day i , and $HRLT_{mn}$ is the minimum day length for the location. The frost reduction factor is estimated with the equation

$$FRST_i = \frac{-T_{mn,i}}{-T_{mn,i} - \exp(af_{j,1} + af_{j,2} \cdot T_{mn,i})}, \quad T_{mn,j} < -1.0^\circ\text{C} \quad \dots [2.254]$$

where $FRST_i$ is the frost damage factor, T_{mn} is the minimum temperature on day i ($^\circ\text{C}$), and $af_{j,1}$ and $af_{j,2}$ are parameters expressing the crop's frost sensitivity. The reduction in standing live biomass is estimated with the equation

$$\Delta B_{AG,i} = 0.5 \cdot B_{AG,i} (1.0 - HUI_i) \cdot \max(FHR_i, FRST_i) \quad [2.255]$$

where ΔB_{AG} is the reduction in above ground biomass (t/ha) on day i , HUI is the heat unit index, and B_{AG} is the above ground biomass (t/ha) on day i .

Note that frost damage is greater when plants are small ($HUI \approx 0$) and approaches 0 as the plants near maturity.

Tillage

The EPIC tillage component was designed to mix nutrients and crop residues within the plow depth, simulate the change in bulk density, and convert standing residue to flat residue. Other functions of the tillage component include simulating ridge height and surface roughness.

Each tillage operation is assigned a mixing efficiency (0-1). The tillage mixing equation is

$$X_{\ell} = (1 - EF) X_{0\ell} + \left(\frac{Z_{\ell} - Z_{\ell-1}}{PD} \right) EF \sum_{k=1}^M X_{ok} \quad [2.256]$$

where X is the amount of the material in layer ℓ after mixing (kg/ha), EF is the mixing efficiency of the tillage operation (0-1), X_0 is the amount of the material before mixing (kg/ha), and M is the number of soil layers in the plow depth, PD (m).

The change in bulk density in the plow layer is simulated for each tillage operation by using the equation

$$BDP_{\ell} = BDP_{0\ell} - (BDP_{0\ell} - \frac{2}{3} BD_{0\ell}) (EF) \quad [2.257]$$

where BDP is the bulk density after tillage, BDP_0 is the bulk density in soil layer ℓ before tillage (t/m^3), and BD_0 is the bulk density of the soil when it has completely settled after tillage. Between tillage operations, the soil settles with each rainfall event according to the equations

$$SZ_{\ell} = \frac{0_{\ell-1}}{Z_{\ell}^{0.6}} \left(1. + \frac{2. SAN_{\ell}}{SAN_{\ell} + \exp(8.597 - 0.075 SAN_{\ell})} \right) \quad [2.258]$$

$$BDP_{\ell,i} = BDP_{\ell,i-1} + (BD_{\ell} - BDP_{\ell,i-1})$$

$$\dots \left(\frac{SZ_{\ell}}{SZ_{\ell} + \exp(3.375 - 0.008835 SZ_{\ell})} \right) \quad [2.259]$$

where SZ_{ℓ} is a scaling factor for soil layer ℓ , $0_{\ell-1}$ is the percolation rate into the layer (mm/d) ($R-Q$ for the top layer), and SAN is the percentage of sand in the layer. Equations 2.258 and 2.259 cause fast settling when rainfall is large and soils are sandy and have been tilled recently. Also, settling is much faster near the surface (this allows simulation of long-term deep chiseling effects). Of course, settling is relatively slow for soils low in sand content, especially in low rainfall areas.

Another important function of the tillage model, converting standing residue to flat residue, is accomplished with the equation

$$SR = (SR_0) \exp[-56.9 (PD) (EF)^2] \quad [2.260]$$

where SR_0 and SR are the standing residue weights before and after tillage (t/ha) and PD is the plow depth (m).

Other functions of the tillage component include simulating ridge height and interval and surface roughness. These variables are specified for each tillage implement. However, the ridge interval and height are computed after each tillage operation to reflect the combined effects of the current and previous operations. The ridge height is estimated by using the equations

$$HR = HT_k + (HT_{k-1} - HT_k) \exp(-PD_k/PD_{k-1}), \quad HT_k < HT_{k-1} \quad [2.261]$$

$$HR = HT_k, \quad HT_k \geq HT_{k-1} \quad [2.262]$$

where HR is the ridge height after the tillage operation k (m), HT is the input ridge height for the tillage operation (m), and k refers to the sequence of operations. After each tillage operation, the ridge interval is set to the input ridge interval of the operation with the greater HT .

The user specifies the date and depth for each tillage operation. The tillage operation is carried out on the specified date if the soil is dry enough. If not, the operation occurs on the next suitable day.

EPIC harvests crops in two basic ways--one kills the crop and the other does not. These two harvest methods along with the harvest index and harvest efficiency provide adequate flexibility to accommodate almost any harvest strategy. The harvest index (HI) is input for each crop and adjusted during each year of simulation as described in the Crop Yield section. Normally, the adjusted HI dictates the fraction of the above ground biomass removed from the crop. Thus, for a grain crop like corn, about 40-50% is removed. However, if corn is cut for silage, the input HI would be about 0.95. An option to override HI allows single crops to be harvested in two different ways. For example, oats could be harvested for grain by using the model adjusted value of $HI \approx 0.4$ and then the straw could be baled by using the appropriate override value (0.5-0.95). The harvest efficiency (HE) indicates what portion of the harvested material actually leaves the field. For most operations, HE may range between 0.7 to 0.95. However, it can be set as low as 0.0 to simulate the plowing under of cover crops.

Plant Environment Control

The plant environment control component provides mechanisms for applying irrigation water, fertilizer, lime, and pesticide or for simulating a drainage system. Instructions for implementing any of these plant environment modifiers will be published separately (Sharpley and Williams in press).

Drainage

Drainage via underground drainage systems is treated as a modification of the natural lateral subsurface flow of the area. Drainage is simulated by indicating which soil layer contains the drainage system and the time required for the drainage system to reduce plant stress. The drainage time (d) replaces the travel time in equation 2.32 for the layer containing the system.

Irrigation

The EPIC user has the option to simulate dryland or irrigated agricultural areas. Sprinkler or furrow irrigation may be simulated and the applications may be user specified or automatic. As implied, the user-specified option allows application dates and rates to be inputted. With the automatic option, the model decides when and how much water to apply. The user must input a plant water stress level to trigger automatic irrigation, the maximum volume applied per growing season, and the minimum time interval between applications. These constraints are used to automatically schedule irrigations.

When automatic irrigation occurs, the application volume raises the water content of the root zone to field capacity and satisfies runoff losses. The volume is calculated with the equation

$$\text{AIR} = \frac{\text{FC} - \text{SW}}{1 - \text{EIR}} \quad [2.263]$$

where AIR is the volume of irrigation water applied (mm), FC is the root zone field capacity (mm), SW is the root zone water content before irrigation (mm), and EIR is the runoff ratio.

Fertilization

EPIC provides two options for applying fertilizer. With the first option, the user specifies dates, rates, and depths of application of N and P. With the second, more automated option, the model decides when and how much fertilizer to apply. The three required inputs are (1) a plant stress level to trigger N fertilizer application, (2) the maximum N application per growing season, and (3) the minimum number of days between applications. At planting time, the model takes a soil sample and applies enough N and P to raise the concentrations in the root zone to those at the start of the simulation. Additional N may be applied during the growing season if the N plant stress factor reaches the trigger level, the minimum number of days between applications is exceeded, and the maximum amount of N fertilizer is not exceeded. Such top dressings, however, are applied only

if N is the active crop growth constraint. Thus, the annual N and P application rates vary according to the crop's needs, the soil's ability to supply those needs, and the magnitude of the N stress relative to water and temperature stresses.

Liming

EPIC simulates the use of lime to neutralize toxic levels of Al and/or to raise soil pH to near-optimum levels. Different algorithms are used to estimate lime requirements of "highly weathered" soils (Oxisols, Ultisols, Quartzipsamments, Ultic subgroups of Alfisols, and Dystric suborders of Inceptisols) (Sharples et al. 1985) and other soils. The highly weathered soils have large amounts of variable-charge clays. Moderate amounts of lime are required to increase their pH to about 5.5 and convert extractable Al to more inactive forms. However, the pH of these soils is highly buffered above pH 5.5, and very large amounts of lime are required to raise the pH to near 7.0. As a result, soils with variable charge clays are usually limed only to reduce Al saturation to acceptable levels.

The Al saturation of each soil layer is estimated with the equations (Jones 1984)

$$ALS_{\ell} = 154.2 - 1.017 BSA_{\ell} - 3.173 C_{\ell} - 14.23 PH_{\ell} , \quad PH_{\ell} \leq 5.6 \quad \dots [2.264]$$

$$ALS_{\ell} = 0. , \quad PH_{\ell} > 5.6 \quad [2.265]$$

where ALS is the Al saturation of soil layer ℓ (%) calculated as KCl-extractable Al divided by effective cation exchange capacity (ECEC), BSA is the base saturation calculated from cation exchange capacity (CEC) determined by the NH_4OAc (pH=7.0) method (%), C is the organic carbon content (%), and PH is the soil pH. For highly weathered soils, the lime required to neutralize toxic Al in the plow layer is estimated with the equation

$$RLA = 0.1 (ALS) (ECEC) (PD) (BD) \quad [2.266]$$

where RLA is the lime required to neutralize Al (t/ha), ECEC is the effective cation exchange capacity (cmol(p+)/kg), BD is the soil bulk density (t/m³), and PD is the plow depth (m).

ECEC is calculated as SMB/ALS (Soil Survey Staff 1982), where SMB (cmol/kg) is the sum of the bases extracted by NH_4OAc (pH=7.0). The constant 0.1 converts cmol(p+)/kg extractable aluminum to equivalent tonnes of $CaCO_3/ha$, assuming 2 cmol(p+) $CaCO_3$ are required to completely neutralize 1 cmol(p+) extractable Al

(Kamprath 1970). At the end of each year, enough lime is applied to meet the lime requirement (RLA) if $RLA \geq 1$ t/ha. If $RLA < 1$ t/ha no lime is applied. When lime is applied, the plow layer PH is raised to 5.4 and ALS is reduced to 0.

For EPIC, soil acidification and decreasing base saturation are caused by addition of fertilizer N and symbiotic N fixation by legumes. All fertilizer N is assumed to derive from anhydrous ammonia, urea, ammonium nitrate, or mixtures of these with equivalent acidifying effects. The $CaCO_3$ equivalent of fertilizer or fixed N is assumed to be 1.8 kg $CaCO_3$ /kg N (Pesek et al. 1971). This is within the range of variation reported by Pierre et al. (1971) for fertilized corn and by Nyatsanga and Pierre (1973) and Jarvis and Robson (1983) for legumes.

At the end of each year of simulation, the plow layer PH is reduced to reflect the change in base saturation caused by N fertilizer and N fixation. The change in base saturation is computed with the equation

$$\Delta BSA = \frac{0.036 (FN + WFX)}{(PD) (BD) (CEC)} \quad [2.267]$$

where FN is the amount of N fertilizer added during the year (kg/ha) and WFX is the amount of N fixation by legumes (kg/ha). The PH value is reduced by using the equation

$$PH = PH_0 - 0.05 \Delta BSA \quad [2.268]$$

where the constant 0.05 approximates the slope of the relationship between PH and ΔBSA for several soils when the for values of BSA are between 60 and 90 (Peech 1965).

For other soils, the lime requirement is the amount of lime needed to raise soil pH to 6.5 according to the equation

$$RLA = 0.01 (PD) (BD) (CEC) (\Delta BSA) \quad [2.269]$$

where ΔBSA is the change in base saturation needed to raise soil pH to 6.5. The constant 0.05 converts ΔBSA (as %) to equivalent tons of $CaCO_3$ per hectare, assuming that applied $CaCO_3$ reacts with equivalent unsaturated CEC. The ΔBSA is estimated with the relation

$$\Delta BSA = \min \left\{ \begin{array}{l} (6.5 - PH) / 0.023 \\ 90 - BSA \end{array} \right. \quad [2.270]$$

For soils that are not highly weathered, lime application is simulated if at the end of the year, $RLA > 2.0$ t/ha. When lime is applied, PH is changed to 6.5, base saturation is increased by ΔBSA , and ALS is set to 0.

Pesticides

The three pests considered in EPIC are insects, weeds, and plant diseases. The effects of all three pests are expressed in the EPIC pest factor. Crop yields are adjusted by multiplying the daily simulated yield by the pest factor. The pest factor ranges from 0 to 1--1 means no pest damage and 0 means total crop destruction by pests. Pesticides are applied on user-specified dates as part of the EPIC tillage operations.

Furrow Diking

Furrow diking is the practice of building small temporary dikes across furrows to conserve water for crop production. Since they reduce runoff, they may also aid in erosion control. The EPIC furrow diking model allows construction of dikes for any ridge spacing and at any interval down the furrows. Dikes may be constructed or destroyed mechanically on any day of the year. If estimated runoff for a particular event exceeds the dike storage volume, overtopping occurs and all of the estimated runoff is lost. If not, all of the rainfall infiltrates and is available for plant use. When runoff destroys the dikes, the model rebuilds them automatically. Rainstorms that do not overtop the dikes cause settling and, thus, reduce storage volume. Settling is estimated with the equation

$$H = H_0 \exp(-0.02 WE - 0.1 Y) \quad [2.271]$$

where H_0 is the dike height (m) before settling, H is the dike height after settling, WE is soil lost by wind-induced erosion (t/ha), and Y is soil lost by water-induced erosion (t/ha). Ridge height is also reduced with the settling function contained in equation 2.271.

The dike storage volume is estimated by assuming that the furrow and the dike are triangular and that the dike side slopes are 2:1. Given the dike and ridge heights, the dike interval, and the slope down the furrow, the volume can be calculated directly. There are two possible dike configurations that require slightly different solutions. Normally, the dike interval is relatively short (1.0-3.0 m) and the slope along the furrow is relatively flat (<1.0%). When the dike is full, water extends from the top of the downslope dike up the furrow to a point above the toe of the upslope dike. The volume is calculated by using cross-sectional areas at the toes of the two dikes. This

approach computes the volume in three parts (between the top and the toe of the downslope dike; between the toes of the two dikes; and between the toe and the waterline on the upslope dike). Beginning at the centerline of the downslope dike, the volume equations are

$$DV_I = \frac{1}{2} (H) (D_2) (W_2) \quad [2.272]$$

$$DV_{II} = \frac{1}{4} (DI - 4 H) [(D_2) (W_2) + (D_3) (W_3)] \quad [2.273]$$

$$DV_{III} = \frac{1}{4} (XD - DI + 2 H) (D_3) (W_3) \quad [2.274]$$

where DV is the dike volume between cross sections (m^3), H is the dike height (m), D is the water depth (m), W is the water surface width (m), DI is the dike interval (m), XD is the distance from the center of the downslope dike to the waterline on the upslope dike (m), and subscripts 2 and 3 refer to cross sections 2 and 3. Cross section 2 is at the toe of the downslope dike and cross section 3 is at the toe of the upslope dike. Water depth is calculated with the equations

$$D_2 = H - 2 (S) (H) \quad [2.275]$$

$$D_3 = H - S (DI - 2 H) \quad [2.276]$$

where S is the slope (m/m) along the furrow. Water surface width is a function of depth and ridge spacing, RS (m).

$$W = RS \left(\frac{D}{H} \right) \quad [2.277]$$

The distance XD is computed with the equations

$$XD = DI - 2 (H - DZ) \quad [2.278]$$

$$DZ = H - (S) (XD) \quad [2.279]$$

where DZ is the water line elevation on the upslope dike. The constant 2 in equation 2.278 comes from the assumed 2:1 dike sideslopes. Simultaneous solution of equations 2.278 and 2.279 yields

$$XD = \frac{DI}{1 + 2 S} \quad [2.280]$$

Substituting D, W, and XD into equations 2.272, 2.273, and 2.274 and summing give

$$DV = \frac{1}{4} \left(\frac{RS}{H} \right) \left(H^2 (1 - 2S)^2 (DI - 2H) + [H - S(DI - 2H)]^2 \left(\frac{DI}{1 + 2S} - 2H \right) \right) \dots [2.281]$$

Equation 2.281 is divided by the total surface area of a furrow dike unit to convert volume from m³ to mm.

$$DV = \frac{250}{(DI) (H)} \left(H^2 (1 - 2S)^2 (DI - 2H) + [H - S(DI - 2H)]^2 \dots \left(\frac{DI}{1 + 2S} - 2H \right) \right) [2.282]$$

In the simpler and more unusual dike configuration, the upslope waterline does not extend to the toe of the upslope dike. Only one cross section is involved and the volume is computed in two parts. Equation 2.272 is used to calculate the most downslope volume, and the upslope volume is calculated with the equation

$$DV_2 = \frac{1}{4} (D_2) (W_2) (H) \left(\frac{1}{S} - 2 \right) [2.283]$$

Adding equations 2.272 and 2.283, substituting D and W, and converting from m³ to mm give

$$DV = \frac{250 H^2 (1 - 2S)^2}{(S) (DI)} [2.284]$$

Thus, the average dike volume of a field is estimated with equation 2.282 or equation 2.284 as dictated by slope and dike height and interval. However, no field is exactly uniform in slope; dike and ridge heights vary, and furrow and dike side slopes may not be triangular. Therefore, the model provides a user-controlled dike efficiency factor to allow for varying conditions across a field. The dike efficiency factor also provides for conservative or optimistic dike system design.

Economics

The economic component of EPIC is more accurately represented as a crop budget and accounting subsystem. The algorithms keep track of the costs of producing and marketing the crops. Costs (and income) are divided into two groups: those costs which do

not vary with yield and those that do. These groups will be addressed in turn. All cost registers are cleared at harvest. All operations after harvest are charged to the next crop in the cropping sequence.

Tillage and (preharvest) machine operation costs are assumed to be independent of yield. These operation costs must be calculated outside of EPIC and are inputted as one variable into the tillage file. This cost cell contains all costs associated with the single operation or activity (e.g., a chiseling activity includes fuel, labor, depreciation, repair, interest, etc., for both the tractor and the chisel). A budget generator program like the Micro Budget Management System (MBMS) (McGrann et al. 1986) is convenient for making these calculations. This is an updated interaction program developed from the Enterprise Budget Generator (Kletke 1979). The MBMS is more compatible with EPIC in that it has output capabilities to itemize cost by machine operation. This information (when converted to metric units) can be inputted directly into the equipment file in EPIC. Farm overhead, land rent, and other fixed costs can be charged to the crop by first creating null operations in the equipment file with machine number and cost information only and then triggering the cost in EPIC with a null activity. Government payments can be credited by using negative cost entries in the same way.

Costs which are yield and management dependent are entered into EPIC in two regions of the input data. Seed costs, seeding rates, and crop prices are entered in the crop parameter file for each crop code. Seed costs are calculated as the product of seeding rate and cost per kilogram. Amendment costs are calculated similarly. The amendments include elemental N and P, irrigation water, and lime. Total cost per hectare is based on the sum of costs for machinery operations, seed, and amendments. Market value per hectare is based on the product of crop yield and net crop price. Net crop price is the market price minus the harvest, hauling, and other processing costs which are yield dependent. The net price must be determined outside EPIC.

When valid cost figures are entered into these EPIC input cells, the model will return annual cost and returns by crop. EPIC budget information is valuable not only for profit analyses but also risk analyses, since the annual distributions of profits and costs can be captured. Risk analyses capability greatly enhances the analytical value of EPIC for economic studies.

SUMMARY AND CONCLUSIONS

The EPIC model was developed to determine the relationship between erosion and productivity in the United States. Nine major aspects of this relationship are addressed: hydrology, weather, erosion, nutrients, plant growth, soil temperature, tillage, plant environment control, and economics. EPIC simulates the physical processes involved simultaneously and realistically, using readily available inputs. The model is generally applicable, computationally efficient, and capable of computing the effects of management changes on outputs.

The EPIC and CARD models were used to accomplish the 1985 national RCA analysis. EPIC has many potential uses beyond the RCA analysis including use (a) in national level conservation policy studies, (b) in program planning and evaluation, (c) in project planning and design, and (d) as a research tool. For example, EPIC can help identify, for a given set of conditions, the best management decisions involving drainage, irrigation, water yield, erosion control, weather, fertilizer and lime applications, pest control, planting dates, tillage, and crop residue. As a research tool, EPIC is useful in developing and validating model components, sensitivity analysis, and field experiment design.

NOTATIONS

- a = ratio of the maximum rainfall amount during a period equal the watershed time of concentration to the total rainfall for the storm
- a_{mn} = minimum value of a
- $a_{.5}$ = ratio of the maximum rainfall amount during 0.5 h to the total rainfall for the storm
- $a_{.5P}$ = $a_{.5}$ value at the peak of gamma distribution
- $a_{.5u}$ = upper limit of $a_{.5}$
- β = probability of a wet day following a dry day divided by probability of a wet day
- κ = decay constant in exponential rainfall rate distribution (h)
- Λ = plant-water-use-rate/soil-depth parameter

σ	=	average channel slope (m/m)
ρ	=	runoff coefficient expressing the watershed infiltration characteristics
λ	=	land surface slope length (m)
δ	=	slope of saturated vapor pressure curve (kPa/°C)
γ	=	psychrometer constant (kPa/°C)
μ	=	uniform random number (0.0-1.0)
ζ	=	power parameter in modified exponential rainfall distribution
Ω_H	=	parameter relating mean relative humidity for wet and dry days
Ω_R	=	ratio of mean solar radition on wet days to mean solar radiation on dry days
Ω_S	=	scaling factor to adjust soil surface temperature on wet days
Ω_T	=	parameter relating mean maximum air temperature for wet and dry days
η	=	gamma distribution shape parameter for estimating wind velocity
ξ	=	slope length power parameter (dependent upon slope) in the Universal Soil Loss Equation (USLE)
ν	=	gamma distribution shape parameter for estimating $a_{.5}$
θ	=	wind direction clockwise from north (radians)
ϕ	=	clockwise angle between field length and north (radians)
Ψ_1, Ψ_2	=	wind erosion parameters related to vegetative cover factor
ω	=	flow coefficient governing mineral P flow between active and stable pools (d ⁻¹)

ξ = scaling parameter for soil temperature damping depth
 χ = dimensionless variable (0-1) expressing frequency with which a specified wind velocity occurs (m/s)
 af_1, af_2 = crop parameters for frost sensitivity
 ah_1, ah_2 = crop parameters that determine the shape of the leaf-area-index-development curve
 ad = crop parameter that governs leaf-area-index-decline rate
 A = drainage area (ha)
 AB = albedo
 AB_s = soil albedo
 AE = average annual wind energy (kWh/m²)
 AIR = volume of irrigation water applied (mm)
 ALO = maximum ALS value a crop can tolerate without stress (%)
 ALS = aluminum saturation of the soil (%)
 ALT = aluminum tolerance index number (1-5)
 AP = labile P in soil (kg/ha)
 AS = aeration root growth stress factor (0-1)
 $ASPR$ = flow rate of P between active and stable mineral P pools (kg/ha/d)
 ATS = root growth stress factor due to aluminum toxicity (0-1)
 b = TP-40 rainfall distribution parameter
 bcv = lagging factor for simulating residue and snow cover effects on soil surface temperature (0-1)
 bn_1, bn_2, bn_3 = crop parameters for plant N concentration equation

bp_1, bp_2, bp_3 = crop parameters for plant P concentration equation
 bt_1, bt_2 = soil strength parameters related to soil texture and bulk density
 B = accumulated plant biomass (above ground and roots) (t/ha)
 B_{AG} = above ground biomass of growing crop (t/ha)
 B_P = potential crop biomass (t/ha)
 BD = soil bulk density (t/m³)
 BD_0 = bulk density of soil completely settled after tillage (t/m³)
 BDD = bulk density of oven dry soil (t/m³)
 $BD3$ = bulk density at 33 kPa water content (t/m³)
 BDL = bulk density near lower boundary of stress (causes no root growth stress) (t/m³)
 BDP = current bulk density as affected by tillage (t/m³)
 BDP_0 = bulk density in soil layer before tillage (t/m³)
 BDU = bulk density near upper stress boundary (root growth stress ≈ 0.2) (t/m³)
 BE = crop parameter--converts energy to biomass (kg/MJ)
 BKN = rate constant for N flow between pools of active and stable organic N (d⁻¹)
 BSA = base saturation as determined by ammonium acetate (NH₄OAc) method (%)
 c_{LP} = labile P concentration in the soil (g/t)
 c_{NB} = optimal N concentration for a plant (kg/t)
 c_{NFR} = N concentration in crop residue (g/g)

c_{NO3}	=	NO3 concentration in water (g/m ³)
c_{ON}	=	concentration of organic N in the soil (g/t)
c_P	=	P concentration in the soil (g/t)
c_{PB}	=	optimal P concentration for a plant (g/t)
c_{PFR}	=	P concentration in crop residue (kg/t)
c_s	=	sediment concentration in runoff (g/m ³)
C	=	organic carbon content of soil (%)
CAC	=	CaCO ₃ concentration in soil (g/t)
CAF	=	fraction of porosity containing water when aeration starts limiting root growth
CE	=	USLE crop management factor
CE_{mn}	=	minimum value of crop management factor
CEC	=	cation exchange capacity as determined by the NH ₄ OAc method (cmol/kg)
CHT	=	crop height (m)
CLA	=	clay content of the soil (%)
CMN	=	rate constant for N mineralization from humus (d ⁻¹)
CN	=	Soil Conservation Service (SCS) runoff curve number
CN_1	=	SCS runoff curve number for moisture condition 1 (dry)
CN_2	=	SCS runoff curve number for moisture condition 2 (average)
CN_3	=	SCS runoff curve number for moisture condition 3 (wet)
CNP	=	C:N and C:P rate parameter for crop residue decay
CNR	=	C:N ratio of crop residue

CPR	=	C:P ratio of crop residue
CV	=	soil cover (above ground biomass plus crop residue) (t/ha)
D	=	water depth in furrow dike system (m)
DCR	=	decay rate constant for fresh organic material (crop residue) (d^{-1})
DD	=	soil temperature damping depth (m)
DE	=	daily wind energy (kWh/m^2)
DI	=	furrow dike interval (m)
DN	=	denitrification rate ($kg/ha/d$)
DP	=	maximum damping depth for soil temperature (m)
DR	=	sediment delivery ratio (sediment yield divided by gross erosion)
DUR	=	rainfall duration (h)
DV	=	furrow dike volume (m^3)
DZ	=	waterline elevation on upslope furrow dike (m)
e_a	=	saturation vapor pressure at mean air temperature (kPa)
e_d	=	vapor pressure at mean air temperature (kPa)
E	=	evaporation (mm)
E_o	=	potential evaporation (mm)
E_p	=	potential evaporation rate of plant water (mm/d)
E_s	=	potential evaporation rate of soil water (mm/d)
EA	=	soil cover index (0-1)
ECEC	=	effective cation exchange capacity (cmol/kg)
EF	=	mixing efficiency of tillage operation (0-1)
EI	=	USLE rainfall energy factor

EIR	=	runoff ratio (volume of irrigation runoff/volume of water applied)
ELEV	=	elevation of site (m)
EN03	=	amount of $\text{NO}_3\text{-N}$ moved from lower layers to the top layer by soil evaporation (kg/ha)
EOS	=	30-day sum of potential evaporation (mm)
ER	=	enrichment ratio (concentration of organic N or total P in the sediment/soil concentrations)
EV	=	daily total evaporation from the soil (mm)
f	=	average infiltration rate during a storm (mm/h)
F	=	frequency with which the largest of a total of τ events occurs
FC	=	field capacity (33 kPa for many soils) water content (mm)
FFC	=	ratio of soil water content above wilting point to difference between field capacity and wilting point
FFC*	=	depth weighted FFC value
FHU	=	crop stage factor governing water stress on harvest index
FHR	=	winter dormancy day length factor for reducing standing live biomass (0-1)
FL	=	field length (m)
FN	=	amount of N fertilizer added (kg/ha)
FON	=	fresh organic N in crop residue (kg/ha)
FOP	=	fresh organic P in crop residue (kg/ha)
FR	=	flat crop residue (t/ha)
FRST	=	factor for estimating frost damage to crop (0-1)
FW	=	field width (m)
FXG	=	crop growth-stage factor regulating N fixation
FXN	=	soil NO_3 content factor governing N fixation

FXR	=	fraction of N uptake provided by N fixation
FXW	=	soil water content factor governing N fixation
FZ	=	depth factor in soil temperature equation
ξ_1, ξ_2, ξ_3	=	crop coefficients relating growing biomass and residue to small grain equivalent
G	=	soil heat flux (MJ/m ²)
h_o	=	net radiation (MJ/m ²)
H	=	furrow dike height (m)
HI	=	potential harvest index--ratio of crop yield to above ground biomass
HIA	=	actual harvest index (harvest index adjusted for water stress)
HMN	=	mineralization rate for active organic N pool (kg/ha/d)
HMP	=	humus P mineralization rate (kg/ha/d)
HMX	=	maximum crop height (m)
HR	=	ridge height (m)
HRLT	=	day length (h)
HRLT _{mn}	=	minimum day length (h)
HT	=	input ridge height for tillage operation (m)
HU	=	daily heat units--average daily temperature minus base temperature of crop (°C)
HUF	=	heat unit factor for driving leaf-area-index development (0-1)
HUFH	=	heat unit factor for estimating harvest index development (0-1)
HUI	=	heat unit index--ratio of accumulated to potential heat units (0-1)
HV	=	latent heat of vaporization (MJ/kg)

I	=	wind erosion soil erodibility index (t/ha)
IR	=	ridge interval (m)
k_d	=	P concentration in sediment divided by that of water (m^3/t)
K	=	USLE soil erodibility factor
KR	=	ridge roughness for wind erosion (mm)
L	=	channel length from most distant point to watershed outlet (km)
L_c	=	average channel flow length for watershed (km)
L_{ca}	=	distance along channel to watershed centroid (km)
LAG	=	lag parameter for estimating soil temperature (0-1)
LAI	=	leaf area index--area of plant leaves relative to the soil surface
LAT	=	latitude of watershed (degrees)
LF_I	=	labile P immobilization factor
LF_u	=	labile P factor for crop uptake (0-1)
LS	=	USLE slope length and steepness factor
MP_a	=	amount in active mineral P pool (kg/ha)
MP_s	=	amount in stable mineral P pool (kg/ha)
MPR	=	flow rate from labile to active mineral P pool (kg/ha/d)
n	=	Manning's roughness coefficient for water flow
ND	=	number of days in a month
NDD	=	number of dry days in a month
NWD	=	number of wet days in a month
O	=	percolation rate (mm/d)

ON	=	organic N content of the soil (kg/ha)
ON _a	=	active organic N pool (kg/ha)
ON _s	=	stable organic N pool (kg/ha)
OP	=	organic P content of the soil (kg/ha)
PAR	=	photosynthetic active radiation (MJ/m ²)
PB	=	barometric pressure (kPa)
PD	=	plow depth (m)
PE	=	factor for water erosion control practice
PH	=	soil pH
PHU	=	potential heat units for crop maturity (°C)
PO	=	soil porosity (mm)
PO1	=	porosity of top 1 m of soil (mm)
PSP	=	P sorption coefficient
PW	=	probability of wet day
P(W/D)	=	probability of a wet day following a dry day
P(W/W)	=	probability of a wet day following a wet day
q _c	=	average flow rate in channel (used to estimate watershed time of concentration) (m ³ /s)
q _p	=	peak runoff rate (m ³ /s)
q* _p	=	peak runoff rate (mm/h)
q _s	=	average surface flow rate (m ³ /s)
Q	=	runoff volume (mm)
Q*	=	runoff volume (m ³)
QR	=	lateral flow rate (mm/d)
QS	=	30-day sum of runoff (mm)

QT	=	total water loss from a soil layer (used to transport NO ₃) (mm)
r	=	rainfall intensity (mm/h)
r _{ep}	=	peak rainfall excess rate (mm/h)
r _p	=	peak rainfall rate (mm/h)
R	=	daily rainfall (mm)
\bar{R}	=	mean daily rainfall (mm)
R _t	=	rainfall amount during time t (mm)
$\bar{R}_{.5}$	=	mean maximum 0.5-h rainfall amount (mm)
R _{.5F}	=	maximum 0.5-h rainfall amount for frequency F (mm)
RA	=	solar radiation (MJ/m ²)
\overline{RA}	=	mean daily solar radiation (MJ/m ²)
RAB	=	net outgoing long wave radiation for clear days (MJ/m ²)
RAD	=	daily mean solar radiation on dry days (MJ/m ²)
RAMX	=	maximum solar radiation possible at a site on a given day (MJ/m ²)
RAW	=	daily mean solar radiation on wet days (MJ/m ²)
RC	=	residue composition factor
RD	=	root depth (m)
RDMX	=	maximum root depth (m)
RE	=	rainfall energy for water erosion equations
REG	=	crop growth constraint (lowest value from among the stress factors estimated for water, nutrients, aeration, and temperature) (0-1)
RFS	=	30-day sum of rainfall (mm)

RGF = root growth constraint (lowest value from among the stress factors estimated for soil strength, temperature, and aluminum toxicity) (0-1)

RH = relative humidity

\bar{RH} = mean of the triangular relative humidity distribution

RHD = daily mean relative humidity on dry days

RHG = relative humidity generated from triangular distribution

RHG* = generated relative humidity adjusted to the mean of the triangular distribution

RHL = lowest relative humidity value that can be generated

RHP = peak of the triangular relative humidity distribution (RHW or RHD)

RHU = largest relative humidity value that can be generated

RHW = daily mean relative humidity on wet days

RLA = lime required to neutralize aluminum in the plow layer (t/ha)

RMN = mineralization rate for fresh organic N (kg/ha/d)

RMP = mineralization rate for fresh organic P (kg/ha/d)

ROK = percent of coarse fragments in the surface soil layer

ROKF = coarse fragment factor

RON = flow rate between active and stable organic N pools (kg/ha/d)

RS = ridge spacing (m)

RSDV = standard deviation on daily rainfall (mm)

RTN = ratio of N in active pool to total organic N

RW = root weight in a soil layer (t/ha)

RWT = total root weight (t/ha)

RZ	=	soil profile depth (m)
s	=	SCS runoff curve number retention parameter (mm)
s _f	=	SCS runoff curve number retention parameter for frozen soil (mm)
S	=	land surface slope (m/m)
SAN	=	sand content of a soil layer (%)
SAT	=	saturation index for top 1 m of soil
SC	=	saturated conductivity of a soil layer--that is, rate of water drainage through a saturated layer (mm/h)
SCF	=	skew coefficient for skewed normal rainfall distribution
SD	=	sun's declination angle (radians)
SDRA	=	standard deviation of daily solar radiation (MJ/m ²)
SDTMX	=	standard deviation of daily maximum temperature (°C)
SDV	=	standard deviation of daily wind velocity (m/s)
SEV	=	potential evaporation from a soil layer (mm)
SEV*	=	soil-water-adjusted evaporation from a soil layer (mm)
SIL	=	silt content of soil (%)
SMB	=	sum of bases (cmol/kg)
SML	=	snowmelt rate (mm/d)
SN	=	N stress factor for crop growth (0-1)
SN _S	=	N stress scaling factor
SND	=	standard normal deviate
SNO	=	water content of snow (mm)
SR	=	standing residue from previous crop (t/ha)
SS	=	root growth stress factor due to soil strength (0-1)

SW	=	soil water content (mm)
SWF	=	soil water factor, associated with water content of soil pores, for a soil layer
t	=	time (h)
t_c	=	watershed's time of concentration (h)
t_{cc}	=	time of concentration for channel flow (h)
t_{cs}	=	time of concentration for surface flow (h)
T	=	temperature ($^{\circ}\text{C}$)
\bar{T}	=	long-term average annual air temperature ($^{\circ}\text{C}$)
T_b	=	base temperature for a crop (plants start growing) ($^{\circ}\text{C}$)
T_{mn}	=	daily minimum air temperature ($^{\circ}\text{C}$)
T_{mx}	=	daily maximum air temperature ($^{\circ}\text{C}$)
T_o	=	optimal temperature for a crop ($^{\circ}\text{C}$)
TD	=	daily mean maximum temperature for dry days ($^{\circ}\text{C}$)
TE	=	long-term extreme maximum and minimum monthly temperatures
TF_N	=	temperature factor for nutrient cycling
TG	=	soil surface temperature ($^{\circ}\text{C}$)
TGB*	=	final estimate of bare soil surface temperature ($^{\circ}\text{C}$)
TGBD	=	bare soil surface temperature on dry days ($^{\circ}\text{C}$)
TGBW	=	bare soil surface temperature on wet days ($^{\circ}\text{C}$)
TH	=	temperature stress factor affecting harvest index (0-1)
TS	=	temperature stress factor for crop growth (0-1)

TT	=	travel time through a soil layer (h)
TT _R	=	lateral flow travel time (d)
TW	=	daily mean maximum temperature for wet days (°C)
u	=	plant water use rate in a soil layer (mm/d)
UP	=	potential plant water use rate for the entire root zone (mm/d)
UC	=	plant-use/soil-water-deficit compensation factor (0-1)
UN	=	actual N uptake rate from a soil layer by a plant (kg/ha/d)
UND	=	plant N demand rate (kg/ha/d)
UNS	=	N supply rate from soil to plants (kg/ha/d)
U _P	=	actual P uptake rate from a soil layer by a plant (kg/ha/d)
UPD	=	plant P demand rate (kg/ha/d)
UPS	=	P supply rate from a soil layer to plants (kg/ha/d)
v _c	=	average channel flow velocity (m/s)
v _s	=	surface flow velocity (m/s)
V	=	mean daily wind speed (m/s)
\bar{V}	=	annual average wind speed (m/s)
V _L	=	lower limit of erosive wind speed (m/s)
V _p	=	wind speed at the peak frequency (m/s)
V _u	=	upper limit of wind speed (m/s)
VE	=	quantity of vegetative cover expressed as small grain equivalent (kg/ha)
VN03	=	amount of flow related NO ₃ -N loss from a soil layer (kg/ha)

w_1, w_2	=	shape parameters for soil water-runoff curve number retention parameter relationship
W	=	water surface width in furrow dike system (m)
WC	=	climatic factor for wind-induced erosion
WE	=	soil loss from wind-induced erosion (t/ha)
WF	=	field length factor for wind-induced erosion
WFX	=	nitrogen fixation by legumes (kg/ha)
WIM	=	N immobilization rate (kg/ha/d)
WIP	=	P immobilization rate (kg/ha/d)
WK	=	soil ridge roughness factor
WL	=	field length along the prevailing wind direction (m)
WN03	=	weight of $\text{NO}_3\text{-N}$ in a soil layer (kg/ha)
WP	=	soil water content of layer at wilting point (mm)
WS	=	water stress factor for crop growth (0-1)
WSYF	=	crop parameter expressing drought sensitivity
WTBL	=	depth from surface to water table (m)
WTL	=	limits of water table--WTMN or WTMX (m)
WTMN	=	minimum water table depth from the surface (m)
WTMX	=	maximum water table depth from the surface (m)
x_1, x_2	=	nutrient enrichment ratio parameters
X	=	material mixed by tillage (nutrients, crop residue, soil properties) (kg/ha)
XD	=	distance from center of downslope furrow dike to water line on upslope dike (m)
Y	=	sediment yield from water-induced erosion (t/ha)
YC	=	period of cultivation before simulation starts (yrs)
YLD	=	crop yield (t/ha)

YON = organic N runoff loss (kg/ha)
YP = sediment phase P lost in runoff (kg/ha)
YSP = soluble P lost in runoff volume (kg/ha)
Z = soil depth from the surface (m)

REFERENCES

- Abruna, F., J. Rodriguez, and S. Silva. 1982. Crop response to soil acidity factors in Ultisols and Oxisols in Puerto Rico. VI. Grain sorghum. *J. Agric. Univ. P.R.* 61:28-38.
- Acevedo, E., T.C. Hsiao, and D.W. Henderson. 1971. Immediate and subsequent growth responses of maize leaves to changes in water status. *Plant Physiol.* 48:631-636.
- Baker, C. K., J.N. Gallagher, and J.L. Monteith. 1980. Daylength change and leaf appearance in winter wheat. *Plant, Cell Environ.* 3:285-287.
- Borg, H. and D.W. Grimes. 1986. Depth development of roots with time: An empirical description. *Trans. ASAE* 29:194-197.
- Brenes, E. and R.W. Pearson. 1973. Root responses of three Gramineae species to soil acidity in an Oxisol and an Ultisol. *Soil Sci.* 116:295-302.
- Cassman, K.G. and D.N. Munns. 1980. Nitrogen mineralization as affected by soil moisture, temperature, and depth. *Soil Sci. Soc. Am. J.* 44:1233-1237.
- Cole, G.W., L.Lyles, and L.J. Hagen. 1982. A simulation model of daily wind erosion soil loss. 1982 ASAE Winter Meeting, Paper No. 82-2575.
- Doorenbos, J. and A.H. Kassam. 1979. Yield response to water. *Irrigation and Drainage Paper 33.* Food Agric. Org. United Nations, Rome.
- Eavis, B.W. 1972. Soil physical conditions affecting seedling root growth. I. Mechanical impedance, aeration, and moisture availability as influenced by bulk density and moisture levels in a sandy loam soil. *Plant Soil* 36:613-622.
- Eik, K. and J.J. Hanway. 1965. Some factors affecting development and longevity of leaves of corn. *Agron. J.* 57:7-12.

- Foy, C.D., H.N. Lafever, J.W. Swartz, and A.L. Fleming. 1974. Aluminum tolerance of wheat cultivars related to region of origin. *Agron. J.* 66:751-758.
- Grossman, R.B., W.D. Nettleton, and B.R. Brasher. 1985. Application of pedology to plant response prediction for tropical vertisols. *In Proc. Fifth Int. Soil Classification Workshop, Sudan, November 2-11, 1982.*
- Hanks, R.J. 1983. Yield and water-use relationships: An overview. pp. 393-411 *In* H.M. Taylor, W.R. Jordan, and T.R.
- Sinclair, eds., *Limitations to Efficient Water Use in Crop Production.* Am. Soc. Agron., Crop Sci. Soc. Am., Soil Sci. Soc. Am., Madison, WI.
- Hazen, Allen. 1930. *Flood Flows, A Study of Frequencies and Magnitudes.* John Wiley & Sons, Inc., New York.
- Hershfield, D.M. 1961. Rainfall frequency atlas of the United States for durations from 30 minutes to 24 hours and return periods from 1 to 100 years. U.S. Dep. Commer., Tech. Paper No. 40, 115 pp.
- Hobbs, J.A. and C.A. Thompson. 1971. Effect of cultivation on the nitrogen and organic carbon content of a Kansas argiustoll [Chernozem]. *Agron. J.* 63:66-68.
- Jarvis, S.C. and A.D. Robson. 1983. The effect of nitrogen nutrition of plants on the development of acidity in western Australian soils. I. Effects with subterranean clover grown under leaching conditions. *Aust. J. Agric. Res.* 34:341-353.
- Jones, C.A. 1983a. A survey of the variability in tissue nitrogen and phosphorus concentrations in maize and grain sorghum. *Field Crops Res.* 6:133-147.
- Jones, C.A. 1983b. Effect of soil texture on critical bulk densities for root growth. *Soil Sci. Soc. Am. J.* 47:1208-1211.
- Jones, C.A. 1984. Estimation of percent aluminum saturation from soil chemical data. *Commun. Soil Sci. Plant Anal.* 15:327-335.
- Jones, C.A. 1985. *C-4 Grasses and Cereals.* John Wiley & Sons, Inc., New York. 419 pp.
- Jones, C.A. and J.R. Kiniry, eds. 1986. *CERES-Maize.* Texas A&M Univ. Press, College Station. 194 pp.

- Jones, C.A., C.V. Cole, A.N. Sharpley, and J.R. Williams. 1984. A simplified soil and plant phosphorus model, I. Documentation. *Soil Sci. Soc. Am. J.* 48(4):800-805.
- Kamprath, E.J. 1970. Exchangeable aluminum as a criterion for liming leached mineral soils. *Soil Sci. Soc. Am. Proc.* 34:252-254.
- Kletke, D.D. 1979. Operation of the enterprise budget generator. *Okla. State Univ., Agric. Exp. Sta. Res. Rep.* P-790, 129 pp.
- Knisel, W.G. 1980. CREAMS, A field scale model for chemicals, runoff, and erosion from agricultural management systems. U.S. Dep. Agric. Conserv. Res. Rep. No. 26, 643 pp.
- Lyles, L. 1983. Erosive wind energy distributions and climatic factors for the West. *J. Soil Water Conserv.* 38(2):106-109.
- McElroy, A.D., S.Y. Chiu, J.W. Nebgen, and others. 1976. Loading functions for assessment of water pollution from nonpoint sources, *Environ. Prot. Tech. Ser.*, EPA 600/2-76-151, 445 pp.
- McGrann, J.M., K.D. Olson, T.A. Powell, and T.R. Nelson. 1986. Microcomputer budget management system user manual. *Dep. Agric. Econ., Texas A&M Univ., College Station.*
- Menzel, R.G. 1980. Enrichment ratios for water quality modeling. pp. 486-492. *In* W. G. Knisel, ed., CREAMS, A field scale model for chemicals, runoff, and erosion from agricultural management systems. U.S. Dep. Agric. Conserv. Res. Rep. No. 26, 643 pp.
- Monsi, M. and T. Saeki. 1953. Uber den Lichtfaktor in den Pflanzengesellschaften und sein Bedeutung fur die Stoffproduktion. *Japan J. Bot.* 14:22-52.
- Monteith, J.L. 1977. Climate and the efficiency of crop production in Britain. *Phil. Trans. Res. Soc. London Ser. B.* 281:277-329.
- Monteith, N.H. and C.L. Banath. 1965. The effect of soil strength on sugarcane growth. *Trop. Agric.* 42:293-296.
- Mugwira, L.M., S.J. Patel, and A.L. Fleming. 1980. Aluminum effects on growth and Al, Ca, Mg, K, and P. levels in triticale, wheat, and rye. *Plant Soil* 57:467-470.

- National Soil Erosion-Soil Productivity Research Planning Committee, USDA-ARS. 1981. Soil erosion effects on soil productivity: A research perspective. *J. Soil Water Conserv.* 36:82-90.
- Nicks, A.D. 1974. Stochastic generation of the occurrence, pattern, and location of maximum amount of daily rainfall. pp. 154-171. *In Proc. Symp. Statistical Hydrology, Aug.-Sept. 1971, Tucson, AZ.* U.S. Dep. Agric., Misc. Publ. No. 1275.
- Nyatsanga, T. and W.H. Pierre. 1973. Effect of nitrogen fixation by legumes on soil acidity. *Agron. J.* 65:936-940.
- Onstad, C.A. and G.R. Foster. 1975. Erosion modeling on a watershed. *Trans. ASAE* 18(2):288-292.
- Pavan, M.A., F.T. Bingham, and P.F. Pratt. 1982. Toxicity of aluminum to coffee in Ultisols and Oxisols amended with CaCO_3 , MgCO_3 , and $\text{CaSO}_4/2\text{H}_2\text{O}$. *Soil Sci. Soc. Am. J.* 46:1201-1207.
- Peech, M. 1965. Lime requirement. *Agronomy* 9:927-932.
- Penman, H.L. 1948. Natural evaporation from open, bare soil and grass. *Proc. Soc. London Ser. A* 193:120-145.
- Pesek, J., G. Stanford, and N.L. Case. 1971. Nitrogen production and use. pp. 217-269. *In R. A. Olson, ed., Fertilizer Technology and Use.* Soil Sci. Soc. Am., Madison, WI.
- Pierre, W.H., J.R. Webb, and W.D. Shrader. 1971. Quantitative effects of nitrogen fertilizer on the development and downward movement of soil acidity in relation to level of fertilization and crop removal in a continuous corn cropping system. *Agron. J.* 63:291-297.
- Priestley, C.H.B. and R.J. Taylor. 1972. On the assessment of surface heat flux and evaporation using large-scale parameters. *Mon. Weather Rev.* 100:81-92.
- Richardson, C.W. 1981. Stochastic simulation of daily precipitation, temperature, and solar radiation. *Water Resour. Res.* 17(1):182-190.
- Richardson, C.W. 1982. Dependence structure of daily temperature and solar radiation. *Trans. ASAE* 25(3):735-739.
- Richardson, C.W. and D.A. Wright. 1984. WGEN: A model for generating daily weather variables. U.S. Dep. Agric., Agric. Res. Ser., ARS-8, 83 pp.

- Ritchie, J.T. 1972. A model for predicting evaporation from a row crop with incomplete cover. *Water Resour. Res.* 8:1204-1213.
- Seligman, N.G. and H. van Keulen. 1981. PAPRAN: A simulation model of annual pasture production limited by rainfall and nitrogen. pp. 192-221 *In* M.J. Frissel and J.A. van Veen, eds., *Simulation of Nitrogen Behaviour of Soil-Plant Systems*, Proc. Workshop, Wageningen, Jan.-Feb. 1980.
- Sharpley, A.N., C.A. Jones, C. Gray, and C.V. Cole. 1984. A simplified soil and plant phosphorus model: II. Prediction of labile, organic, and sorbed phosphorus. *Soil Sci. Soc. Am. J.* 48:800-805.
- Sharpley, A.N., C.A. Jones, C. Gray, and others. 1985. A detailed phosphorus characterization of seventy-eight soils. *U.S. Dep. Agric., Agric. Res. Ser., ARS-31*, 32 pp.
- Sharpley, A.N. and J.R. Williams, eds. [In press.] EPIC -- Erosion/Productivity Impact Calculator 2: User manual. U.S. Department of Agriculture, Technical Bulletin No. 1768.
- Simanton, J.R., E. Rawitz, and E.D. Shirley. 1984. Effects of rock fragments on erosion of semiarid rangeland soils. Chapter 7, pp. 65-72. *In* *Erosion and Productivity of Soils Containing Rock Fragments*. Soil Sci. Soc. Am., Madison, WI.
- Soil Survey Staff. 1982. Procedures for collecting soil samples and methods of analysis for soil survey. U.S. Dep. Agric., Soil Conserv. Ser., Soil Survey Investigations Report No. 1 (revised August 1982). Washington, DC.
- Taylor, H.M. 1983. A program to increase plant available water through rooting modification. pp. 463-472 *In* *Root Ecology and Its Practical Application*. Int. Symp., Gumpenstein. September 1982. Bundesanstalt fur alpenlandische Landwirtschaft, A-8952 Irding.
- Taylor, H.M., G.M. Robertson, and J.J. Parker, Jr. 1966. Soil strength--root penetration relations for medium to coarse-textured soil materials. *Soil Sci.* 102:18-22.
- Thornthwaite, C.W. 1931. Climates of North America according to a new classification. *Geogr. Rev.* 21:633-655.
- Tollenaar, M., T.B. Daynard, and R.B. Hunter. 1979. Effect of temperature on rate of leaf appearance and flowering date of maize. *Crop Sci.* 19:363-366.
- U.S. Department of Agriculture, Soil Conservation Service. 1972. *National Engineering Handbook, Hydrology Section 4, Chapters 4-10.*

U.S. Department of Commerce. 1968. Climatic atlas of the United States. Environmental Science Services Administration, Environmental Data Service. 80 pp.

U.S. Department of Commerce. 1979. Maximum short duration rainfall. National Summary, Climatic Data.

Watts, W.R. 1972. Leaf extension in Zea mays. II. Leaf extension in response to independent variation of the temperature of the apical meristem, of the air around the leaves, and of the rootzone. J. Exp. Bot. 23:713-721.

Williams, J.R. 1975. Sediment yield prediction with universal equation using runoff energy factor. U.S. Dep. Agric., Agric. Res. Ser., ARS-S-40.

Williams, J.R. 1983. The physical components of the EPIC model. Proc. Int. Conf. on Soil Erosion and Conservation, January 16-22, 1983, Honolulu, HI.

Williams, J.R. and R.W. Hann. 1978. Optimal operation of large agricultural watersheds with water quality constraints. Texas Water Resources Institute, Texas A&M Univ., Tech. Rep. No. 96, 152 pp.

Williams, J.R. and K.G. Renard. 1985. Assessments of soil erosion and crop productivity with process models (EPIC). pp. 67-103. In R.F. Follett and B.A. Stewart, eds., Soil Erosion and Crop Productivity. Am. Soc. Agron., Crop Sci. Soc. Am., Soil Sci. Soc. Am., Madison, WI. 533 pp.

Williams, J.R., P.T. Dyke, and C.A. Jones. 1983a. EPIC--A model for assessing the effects of erosion on soil productivity. pp. 553-572. In W.K. Lauenroth, C.V. Skogerboe, and M. Flug, eds., Analysis of Ecological Systems: State-of-the-Art in Ecological Modeling. Proc. Third Int. Conf. on State-of-the-Art in Ecological Modeling, May 24-28, 1982, Colorado State Univ.

Williams, J.R., K.G. Renard, and P.T. Dyke. 1983b. A new method for assessing the effect of erosion on productivity--The EPIC model. J. Soil Water Conserv. 38:381-383.

Williams, J.R., C.A. Jones, and P.T. Dyke. 1984a. The EPIC model and its application. pp. 111-121. In Proc. ICRISAT-IBSNAT-SMSS Symp. on Minimum Data Sets for Agrotechnology Transfer, March 21-26, 1983, Hyderabad, India.

Williams, J.R., C.A. Jones, and P.T. Dyke. 1984b. A modeling approach to determining the relationship between erosion and soil productivity. Trans. ASAE 27:129-144.

Williams, J.R., J.W. Putman, and P.T. Dyke. 1985. Assessing the effect of soil erosion on productivity with EPIC. pp. 215-226. In Erosion and Soil Productivity, Proc. Nat. Symp. Erosion Soil Productivity. ASAE Publ. 8-85.

Wischmeier, W.H. and D.D. Smith. 1978. Predicting rainfall erosion losses, a guide to conservation planning. U.S. Dep. Agric., Agric. Handb. No. 537, 58 pp.

Woodruff, N.P. and F.H. Siddoway. 1965. A wind erosion equation. Soil Sci. Soc. Am. Proc. 29(5):602-608.

3. WEATHER GENERATOR DESCRIPTION

C.W. Richardson and A.D. Nicks

ABSTRACT

The weather generator in the EPIC model can generate daily values of precipitation, maximum temperature, minimum temperature, solar radiation, wind speed, and wind direction that approximate the observed weather for a site. The parameters required to generate a sample of weather data have been defined for locations in the 48 contiguous States. The weather generator offers a convenient method of obtaining the numerous long sequences of weather data that are required for the EPIC simulations.

INTRODUCTION

Climate and daily weather have a major influence on hydrology, erosion, nutrient cycling, and crop growth. EPIC requires daily values of precipitation, air temperature, solar radiation, wind speed, and wind direction. For long-term simulations, however, these values must be obtained by prediction. A weather generator model was, therefore, developed to generate the daily weather data with the same statistical characteristics as the actual weather at any given location.

The model is based on that described by Richardson (1981a); however, we introduced several assumptions to simplify the use of the model and also added a wind component. The parameters governing the generation of the weather variables have been determined for many locations in the United States and are given in Richardson and Wright (1984).

WEATHER GENERATOR DESCRIPTION

The weather model generates daily values of precipitation (p), maximum temperature (t_{\max}), minimum temperature (t_{\min}), solar radiation (r), wind speed (v), and wind direction (θ) over years for any given location (see "Notations" section in this chapter).

The model is designed to preserve the dependence in time, the internal correlation, and the seasonal characteristics that exist in actual weather data for the location. Precipitation and wind are generated independent of the other variables. Maximum temperature, minimum temperature, and solar radiation are generated, conditioned on whether the day is wet or dry.

Precipitation

A first-order Markov chain is used to generate the occurrence of wet or dry days. When a wet day is generated the precipitation amount is generated according to a skewed normal distribution (Nicks 1974).

With the first-order Markov chain model the probability of rain on a given day is conditioned on the wet or dry status of the previous day. A wet day is defined as having at least 0.2 mm of rain. Let $P(W/W)$ be the probability of day i being wet if day $i-1$ is wet, and let $P(W/D)$ be the probability of day i being wet if day $i-1$ is dry. Then,

$$P(D/W) = 1 - P(W/W) \quad [3.1]$$

$$P(D/D) = 1 - P(W/D)$$

where $P(D/W)$ is the probability of a dry day if day $i-1$ is wet and $P(D/D)$ is the probability of a dry day if day $i-1$ is dry. Therefore, the transition probabilities are fully defined if $P(W/W)$ and $P(W/D)$ are given.

Precipitation amount, assuming a skewed normal distribution is given by

$$p = \mu + \frac{2\sigma}{g} \left[\left[\frac{g}{6} \left(z - \frac{g}{6} \right) + 1 \right]^3 - 1 \right] \quad [3.2]$$

where p is daily precipitation amount, μ is the mean size of the precipitation event given a wet day, σ is the standard deviation, g is the skewness coefficient, and z is a standard normal deviate.

The values of $P(W/W)$, $P(W/D)$, μ , σ and g change during the year at most locations. In the weather generator, each of these precipitation parameters is held constant for each month but is varied monthly. The monthly values of these parameters have been determined for numerous locations in the United States. The parameters are used with a Markov chain generation procedure and equation 3.2 to generate daily precipitation values.

Temperature and Solar Radiation

The procedure used to generate daily values of t_{\max} , t_{\min} , and r has been described by Richardson (1981a). The procedure is based on the weakly stationary generating process given by Matalas (1967). The equation is

$$x_i(k) = Ax_{i-1}(k) + B\epsilon_i(k) \quad [3.3]$$

where $x_i(k)$ is a 3 X 1 matrix for day i , the elements of which are residuals of t_{\max} ($k = 1$), t_{\min} ($k = 2$), and r ($k = 3$); A and B are 3 X 3 matrices whose elements are defined such that the new sequences of residuals have the desired serial correlation and cross correlation coefficients, and ϵ_i is a 3 X 1 matrix of independent random components. The A and B matrices are given by

$$A = M_1 M_0^{-1} \quad [3.4]$$

$$BB^T = M_0^{-1} M_1 M_0^{-1} M_1^T \quad [3.5]$$

where the superscripts -1 and T denote the inverse and transpose of the matrix. M_0 and M_1 are matrices containing the lag-zero cross correlation coefficients and the lag-one serial correlation coefficients, respectively.

The seasonal and regional patterns of the correlation coefficients were described by Richardson (1982b). The seasonal and spatial variation in the correlation coefficients are relatively small. If the small variations are neglected and the average values of the correlation coefficients given by Richardson (1982b) are used, the A and B matrices become

$$A = \begin{bmatrix} 0.567 & 0.086 & -0.002 \\ 0.253 & 0.504 & -0.050 \\ -0.006 & -0.039 & 0.244 \end{bmatrix} \quad [3.6]$$

$$B = \begin{bmatrix} 0.781 & 0 & 0 \\ 0.328 & 0.637 & 0 \\ 0.238 & -0.341 & 0.873 \end{bmatrix} \quad [3.7]$$

The A and B matrices given in equations 3.6 and 3.7 are used with equation 3.3 to generate new sequences of the residuals of the t_{\max} , t_{\min} , and r that are serially and cross correlated.

The final daily generated values of t_{\max} , t_{\min} , and r are the residual elements generated with equation 3.3 plus a seasonal mean and standard deviation, as given by the equation

$$t_i(k) = x_i(k) \cdot s_i(k) + m_i(k) \quad [3.8]$$

where $t_i(k)$ is the final daily value of t_{\max} ($k = 1$), t_{\min} ($k = 2$), and r ($k = 3$); $s_i(k)$ is the standard deviation and $m_i(k)$ is the seasonal mean for day i . The values of $m_i(k)$ and $s_i(k)$ are conditioned on the wet or dry status as determined from the precipitation component of the model. By expressing equation 3.8 in terms of the coefficient of variation ($c = s/m$) rather than the standard deviation, the equation becomes

$$t_i(k) = m_i(k) [x_i(k) \cdot c_i(k) + 1] \quad [3.9]$$

The seasonal change in the means and coefficients of variation may be described by

$$u_i = \bar{u} + C \cos(0.0172(i-D)), \quad i = 1, \dots, 365 \quad [3.10]$$

where u_i is the value of $m_i(j)$ or $c_i(j)$ on day i , \bar{u} is mean of u_i , C is the amplitude of the harmonic, and D is the position of the harmonic in days. Values of the \bar{u} , C , and D have been determined for the mean and coefficient of variation of each weather variable (t_{\max} , t_{\min} , r) and for the wet or dry condition. These values were determined from daily weather data for many locations. There were no detectable differences in the means and coefficients of variation for t_{\min} on wet or dry days. Some of the parameters were strongly location dependent while other parameters did not change significantly with location. The D values for the descriptors of temperature (means and coefficients of variation of t_{\max} and t_{\min}) were near 200 days for all locations. Similarly, the D values for r were about 172 days (summer solstice) for all locations. Therefore, all the D values for temperature are assumed to be 200 days and all the D values for solar radiation are assumed to be 172 days.

Most of the \bar{u} and C values are location dependent. The values for each parameter have been calculated for locations in the United States. Contour maps of the parameters were developed and are given in Richardson and Wright (1984).

Wind

The wind component provides for generating daily values of wind speed and direction by a described procedure (Richardson 1982a). Wind speed is generated by using a two-parameter gamma distribution expressed as

$$f(v) = \frac{\gamma_j \lambda_j v^{\lambda_j - 1} e^{-\lambda_j v}}{\Gamma(\lambda_j)} \quad [3.11]$$

where λ_j and γ_j are distribution parameters for month j and v is daily wind speed. The values of λ_j and γ_j are estimated during the method of moments by

$$\lambda_j = \bar{v}_j^2 / s_j^2 \quad [3.12]$$

and

$$\lambda_j = \bar{v}_j / s_j^2 \quad [3.13]$$

where \bar{v}_j is the mean daily wind speed and s_j is the standard deviation of daily wind speed. The "Climatic Atlas of the United States" (U.S. Department of Commerce 1968) contains values of \bar{v}_j for many locations. The mean annual wind speed (\bar{v}_y) and the standard deviation of hourly wind speed on an annual basis (s_h) are also available in the "Climatic Atlas". We found that a correction factor of 0.7 is appropriate for converting the standard deviation of hourly wind speed to standard deviation of daily wind speed.

If the coefficient of variation of daily wind speed (c_v) for a location is assumed to be constant over the year, c_v may be estimated by

$$c_v = 0.7s_h/\bar{v}_y \quad [3.14]$$

The s_j values may be calculated by

$$s_j = c_v \cdot \bar{v}_j \quad [3.15]$$

The \bar{v}_j and s_j values are used with a gamma generation procedure to generate daily wind speeds.

Wind direction (θ) is generated from the cumulative probability distribution of wind direction. The "Climatic Atlas" gives for each month the percentage of days the wind blows from each of 16 directions by location. These 16 percentages are assembled to form a cumulative probability distribution for each month. The wind direction is determined by drawing a uniformly distributed random number and locating its position on the appropriate monthly cumulative probability distribution.

Precipitation and Temperature Correction

For most locations, the generated monthly precipitation values and temperatures will agree closely with the means obtained from observed data. For other locations, however, agreement will be poor because of differences due to the temporal and spatial smoothing inherent in the model, topographic features of the locations, or other factors. The weather generator can be directed to correct these differences if observed mean monthly values are available. Such observed values are available for selected locations from many sources.

For any given month, the precipitation that would be generated with the Markov-chain skewed normal model over a large number of years may be calculated as

$$G_j = U_j \cdot N_j \cdot P(W)_j \quad [3.16]$$

where G_j is the model-generated, mean precipitation for the month, U_j is the mean size of the precipitation event on a wet day, $P(W)_j$ is the unconditional probability of a wet day, and N_j is the number of days in the month. $P(W)_j$ can be calculated from the Markov chain conditional probabilities by

$$P(W)_j = P(W/D)_j / (1 - P(W/W)_j + P(W/D)_j) \quad [3.17]$$

The precipitation correction factor, K_j , for any given month can then be calculated as

$$K_j = H_j / G_j \quad [3.18]$$

where H_j is the month's mean observed precipitation. The month's generated daily precipitation amounts are corrected by multiplying by K_j .

The temperature correction may be based either on observed mean monthly temperature or on mean maximum and mean minimum temperatures, depending on the type of data available for the location. If the observed mean monthly temperature is available, the correction factor is calculated as the difference between that temperature and the generated mean monthly temperature. Then, generated daily maximum and minimum temperatures are both corrected by addition to the correction factor. If the observed mean monthly maximum and mean minimum temperatures are available, correction factors for maximum temperature and minimum temperature are computed independently.

EXAMPLE APPLICATION OF THE WEATHER GENERATOR

The weather generator procedure may be illustrated by comparing a sample of generated data with observed data. More extensive tests of the weather generator are presented in chapter 4.

A 30-year sample of weather data was generated for Lansing, MI. The precipitation, temperature, and radiation parameters were determined by entering the latitude and longitude into a program that describes the spatial pattern of the parameters within the 48 contiguous States as given by Richardson and Wright (1984). The wind parameters were obtained from the "Climatic Atlas."

Tables 3.1 - 3.3 show that the generated means for precipitation, daily maximum and minimum temperatures, and daily solar radiation by month are good approximations of the corresponding observed means and that use of the correction factors improves the agreement between the generated and observed means.

Table 3.4 shows good agreement between the generated and observed means of wind speed by month.

Table 3.5 shows the agreement between the generated and observed data on the percentage of days the wind direction is from a given quadrant in December. As indicated by both sets of data, the wind tends to be from the southwest (180-270 degrees) or northwest (270-360 degrees).

Table 3.1
Mean amounts of precipitation by month for Lansing, MI, as obtained from observation, generation, and generation with correction.

Month	Mean precipitation amount, mm		
	Observed ¹	Generated	Generated (corrected)
Jan	47.5	52.3	47.0
Feb	47.0	43.9	45.5
Mar	47.5	61.7	47.2
Apr	73.2	87.6	75.9
May	76.4	88.4	86.1
June	82.8	93.5	80.0
July	90.2	72.4	80.0
Aug	85.6	67.0	76.7
Sept	50.3	67.1	51.8
Oct	66.5	62.0	55.4
Nov	57.2	62.0	55.4
Dec	42.4	57.1	41.4
Annual	766.6	815.0	752.3

¹ Obtained from "Climatic Atlas of the United States" (U.S. Department of Commerce 1968) and based on data for 1931-60.

Table 3.2

Mean daily maximum temperature and minimum temperatures by month for Lansing, MI, as obtained from observation, generation, and generation with correction

Month	Mean maximum temperature, C			Mean minimum temperature, C		
	Observed ¹	Generated	Generated (corrected)	Observed ¹	Generated	Generated (corrected)
Jan	-0.5	-1.0	-0.3	-8.2	-9.4	-8.4
Feb	0.2	0.6	0.3	-7.9	-8.1	-8.2
Mar	3.9	6.0	4.4	-4.9	-3.4	-4.7
Apr	13.1	12.9	13.3	1.9	2.3	1.7
May	19.8	20.0	19.5	7.3	8.1	6.7
June	25.0	25.9	24.9	13.2	13.5	13.2
July	27.4	28.1	27.1	15.3	15.5	15.3
Aug	26.4	26.2	25.8	14.2	14.0	14.1
Sept	21.9	21.9	22.2	9.6	10.0	9.9
Oct	16.6	14.7	17.0	4.9	4.2	5.5
Nov	6.8	6.9	7.0	-1.9	-2.7	-2.0
Dec	1.0	0.9	0.9	-6.2	-7.4	-6.3
Annual	13.5	13.6	13.5	3.1	3.0	3.1

¹ Obtained from "Climatic Atlas of the United States" (U.S. Department of Commerce, 1968) and based on data for 1931-60.

Table 3.3
 Mean daily solar radiation by
 month for Lansing, MI, as obtained
 from observation and generation

Month	Mean solar radiation, ly	
	Observed ¹	Generated
Jan	121	120
Feb	210	199
Mar	309	306
Apr	359	430
May	483	535
June	547	585
July	540	563
Aug	466	491
Sept	373	367
Oct	255	243
Nov	136	145
Dec	108	103
Annual	311	341

¹ Obtained from "Climatic Atlas of the United States" (U.S. Department of Commerce 1968) and based on 11 years of data.

Table 3.4
 Mean daily wind speed by month for
 Lansing, MI, as obtained from
 observation and generation

Month	Mean windspeed, m/s	
	Observed ¹	Generated
Jan	4.9	5.0
Feb	4.5	4.6
Mar	5.8	5.5
Apr	4.5	4.5
May	4.5	4.4
June	4.5	4.4
July	4.0	3.9
Aug	4.0	4.0
Sept	3.1	3.2
Oct	3.1	3.2
Nov	4.0	4.0
Dec	4.9	4.9
Annual	4.3	4.3

¹ Obtained from "Climatic Atlas of the United States" (U.S. Department of Commerce 1968) and based on data for 1951-60.

Table 3.5
 Direction of December winds by quadrant
 for Lansing, MI, as shown by observation
 and generation

Quadrant, deg.	Percentage of days with wind from indicated quadrant	
	Observed ¹	Generated
0-90	15	23
90-180	14	7
180-270	38	40
270-360	34	29

¹ Obtained from "Climatic Atlas of the United States" (U.S. Department of Commerce 1968) and based on data for 1951-60.

NOTATIONS

A	= 3 X 3 matrix
B	= 3 X 3 matrix
C	= amplitude of Fourier series
c	= coefficient of variation
D	= position of harmonic of Fourier series (days)
G	= theoretical, model-generated, mean monthly precipitation (mm)
g	= skewness coefficient of precipitation amount
H	= observed mean monthly precipitation (mm)
h	= subscript denoting hourly value
i	= subscript denoting day of year
j	= subscript denoting month of year
K	= precipitation correction factor
k	= index identifying maximum temperature (k=1), minimum temperature (k=2), or solar radiation (k=3)
M ₀	= 3 X 3 lag-zero cross correlation matrix
M ₁	= 3 X 3 lag-zero serial correlation matrix
m	= mean of t _{max} , t _{min} , or r
N	= number of days in month
p	= daily precipitation (mm)
P(W)	= unconditional probability of a wet day

$P(D/D)$ = probability of a dry day given dry on previous day
 $P(D/W)$ = probability of a dry day given wet on previous day
 $P(W/D)$ = probability of a wet day given dry on previous day
 $P(W/W)$ = probability of a wet day given wet on previous day
 r = daily solar radiation (lys)
 s = standard deviation of t_{max} t_{min} , or r
 T = symbol denoting transpose of matrix
 $t(k)$ = generated value of t_{max} , t_{min} , or r
 t_{max} = daily maximum temperature ($^{\circ}C$)
 t_{min} = daily minimum temperature ($^{\circ}C$)
 U = mean size of precipitation events on a wet day (mm)
 u = daily value of m or c from Fourier series
 \bar{u} = mean of u for the year
 v = daily wind speed (m/s)
 \bar{v} = mean daily wind speed (m/s)
 $x(k)$ = 3 X 1 matrix of residuals of t_{max} , t_{min} , or r
 y = subscript denoting annual value
 γ = gamma distribution parameter
 $\epsilon(k)$ = 3 X 1 matrix of independent random components
 θ = wind direction, clockwise from north
 λ = gamma distribution parameter
 μ = mean precipitation amount on a wet day (mm)
 σ = standard deviation of precipitation amount on a wet day (mm)

REFERENCES

- Matalas, N.C. 1967. Mathematical assessment of synthetic hydrology. *Water Resour. Res.* 3:937-945.
- Nicks, A.D. 1974. Stochastic generation of the occurrence, pattern, and location of maximum amount of daily rainfall. In *Proceedings of the Symposium on Statistical Hydrology*, Tucson, AZ. U.S. Dept. Agric. Misc. Publ. 1275. pp. 154-171.
- Richardson, C.W. 1981a. Stochastic simulation of daily precipitation, temperature, and solar radiation. *Water Resour. Res.* 17:182-190.
- Richardson, C.W. 1981b. A comparison of three distributions for the generation of daily rainfall amounts. In *Proceedings of the International Symposium on Rainfall-Runoff Modeling*. May 18-21, Mississippi State, MS. Published by Water Resources Publishing, CO.
- Richardson, C.W. 1982a. A wind simulation model for wind erosion estimation. ASAE Paper No. 82-2576, 12 pp.

Richardson, C.W. 1982b. Dependence structure of daily temperature and solar radiation. Trans. ASAE 25:735-739.

Richardson, C.W. and D.A. Wright. 1984. WGEN: A model for generating daily weather variables. U.S. Dept. Agric., Agric. Res. Ser., ARS-8. 83 pp.

U.S. Department of Commerce. 1968. Climatic Atlas of the United States. Environmental Science Services Administration, Environmental Data Service. 80 pp.

4. EVALUATION OF THE EPIC MODEL WEATHER GENERATOR

A.D. Nicks, C.W. Richardson, and J.R. Williams

ABSTRACT

The weather generator for the EPIC model was independently tested and evaluated at 134 weather stations located in the contiguous United States. Generator inputs were calculated from data recorded over the period 1951 to 1970 for each of these locations, which consisted mostly of first order National Weather Service stations. These parameters were then used to generate ten 10-year runs at each station for daily rainfall, solar radiation, and maximum and minimum air temperatures. Mean monthly values of generated data (means of 10 runs) were then compared with the calculated period 1951-70 means (20 years) and the normal means published for the stations from 1931 to 1960. In less than 10 percent of the cases for rainfall and maximum air temperature, only 3 months or less were significantly different from the period mean for these variables. The weather generator model was considered to be adequate for the weather generating task required by EPIC.

INTRODUCTION

The weather generator component of the EPIC model generates daily information on the occurrence and amount of precipitation, maximum and minimum temperatures, and total solar radiation by using Fourier coefficients and parameters that govern these weather variables. The coefficients and parameters, which vary with geographic location, are all that are required as inputs. This chapter presents the results of an independent evaluation of the weather generator for selected sites within the contiguous United States. Theories supporting the generating techniques are well documented elsewhere and will be discussed only briefly in this report. Evaluation and development of the concepts have been described previously (Nicks, 1974, Nicks 1975, Nicks and Harp 1980, Richardson 1981). The weather generator model has also been described (Williams et al. 1982).

The daily weather variables of precipitation, temperature, and radiation are used by EPIC to simulate runoff, soil erosion, chemical transport, soil water status, and other processes and conditions in the soil-plant-water environment. In the simulation, EPIC calculates other weather and weather-dependent variables such as mean daily air temperature, soil temperature, snow accumulation, snowmelt, evaporation, and evapotranspiration. Wind data such as daily mean speed and direction are calculated with a separate wind generation model.

EVALUATION METHOD

The method used to evaluate the weather generator for EPIC was to select first order weather stations across the United States and then for each station (1) generate ten 10-year simulations of daily weather data, (2) compute monthly means of the weather data from the 10 simulations, and (3) compare the monthly means with two type of observed means--monthly period means and monthly normal means, which are described later in this section.

Table 4.1 lists the 134 first-order weather stations that were selected for testing, and figure 4.1 shows their geographic distribution.

Table 4.2 shows the two types of inputs needed for weather generation. The first type consists of parameters required to predict the occurrence of precipitation during each month and the amount of precipitation on each wet day. These parameters include the probability of a wet day or a dry day occurring directly after a given wet day; standard deviation; and skew coefficient. We calculated these parameters for the test stations, using a computer tape of weather data maintained at the National Oceanic and Atmospheric Administration's (NOAA's) National Weather Data Center at Asheville, NC. The second type of inputs consists of Fourier coefficients for generating the daily maximum and minimum air temperatures and total solar radiation. We calculated the coefficients from the Center's data files, called WBAN, for available locations and plotted the values on maps. Isovalue lines were then drawn; and the coefficients for the 134 stations used in the study were manually tabulated from the maps.

Also calculated from the data filed at the Center were the monthly means of weather variables, which are referred to as monthly "period means." As shown in table 4.1, the period of record on file ranged from 3 to 103 years; but for the most part it spanned 20 years, from 1951 to 1970. The record for each station was thus the basis of the inputs (parameters and Fourier coefficients) for the weather generator, the simulated monthly means of weather variables, and the observed monthly period means. Regardless of the length of the record-keeping period, all inputs and monthly means were representative of the weather during that period and could very well be adjusted up or down in magnitude if additional data were added to the record.

The monthly "normal means" were derived from the 1931-60 normal weather data that had been published for the 134 stations (Water Information Center 1974). The monthly period and normal means were usually different. In fact, they were often significantly different, as will be demonstrated in the test results.

Table 4.1

List of selected first order weather stations selected to test the EPIC climate generator, with longitude and latitude in degrees and hundredths

Station	Longitude	Latitude	Period of record ¹
Albany, NY	73.48	42.45	25
Albuquerque, NM	106.62	35.05	32
Amarillo, TX	101.70	35.23	28
Asheville, NC	82.32	35.26	5
Atlanta, GA	84.43	33.65	34
Augusta, GA	81.58	33.22	18
Austin, TX	97.42	30.18	27
Bakersfield, CA	119.05	35.42	32
Baltimore, MD	76.67	39.18	17
Baton Rouge, LA	91.09	30.32	7
Billings, MT	108.53	45.80	36
Birmingham, AL	86.45	33.34	62
Bismarck, ND	100.45	46.46	18
Blue Canyon, CA	120.70	39.28	30
Boise, ID	116.22	43.57	3
Boston, MA	71.03	42.37	17
Brownsville, TX	97.43	25.90	29
Buffalo, NY	78.73	42.93	28
Burns, OR	119.03	43.35	21
Caribou, ME	68.01	46.52	32
Charleston, SC	80.03	32.90	27
Charleston, WV	81.60	38.37	73
Chattanooga, TN	85.12	35.02	79
Cheyenne, WY	104.82	41.15	22
Chicago, IL	87.75	41.78	26
Cleveland, OH	81.51	41.24	16
Colorado Springs, CO	104.43	38.49	19
Columbia, MO	92.22	38.58	29
Columbia, SC	81.07	33.57	22
Columbus, OH	82.88	40.00	79
Concord, NH	71.50	43.20	87
Corpus Christi, TX	97.50	27.77	30
Dallas, TX	96.85	32.85	28
Denver, CO	104.88	39.77	33
Des Moines, IA	93.65	41.53	27
Detroit, MI	83.00	42.40	32
Dodge City, KS	97.97	37.46	15
Dubuque, IA	90.42	42.24	16
Duluth, MN	92.11	46.50	30
Elko, NV	115.47	40.50	27

Table 4.1--Continued
 List of selected first order weather
 stations selected to test the EPIC
 climate generator, with longitude and
 latitude in degrees and hundreths

Station	Longi- tude	Lati- tude	Period of record ¹
El Paso, TX	106.40	31.80	29
Eureka, CA	124.10	40.48	59
Evansville, IN	87.32	38.03	17
Flagstaff, AZ	111.40	35.08	16
Fort Smith, AR	94.22	35.20	23
Fort Wayne, IN	85.12	41.00	11
Fresno, CA	119.43	36.46	20
Galveston, TX	94.48	29.18	98
Grand Island, NE	98.32	40.97	27
Grand Junction, CO	108.32	39.07	21
Grand Rapids, MI	85.31	42.53	3
Great Falls, MT	111.22	47.29	33
Green Bay, WI	88.08	44.29	8
Greensboro, NC	80.56	35.13	30
Hartford, CT	72.68	41.93	53
Havre, MT	109.46	48.33	10
Helena, MT	112.00	46.36	30
Houston, TX	95.17	29.39	36
Huron, SD	98.13	44.23	18
Indianapolis, IN	86.27	39.73	18
Jackson, MS	90.22	32.33	18
Jacksonville, FL	81.70	30.50	30
Kalispell, MT	114.16	48.18	21
Kansas City, MO	94.60	39.12	35
Knoxville, TN	83.59	35.49	87
La Crosse, WI	91.15	43.52	7
Las Vegas, NV	115.17	36.08	21
Lexington, KY	84.36	38.02	74
Little Rock, AR	92.23	34.73	27
Louisville, KY	85.73	38.18	85
Macon, GA	83.39	32.42	20
Madison, WI	89.33	43.13	18
Meachum, OR	118.24	45.30	13
Medford, OR	122.52	42.22	28
Memphis, TN	89.59	35.03	86
Miami, FL	80.27	25.80	29
Miles City, MT	105.52	46.26	33
Milford, UT	113.01	38.26	9

Table 4.1--Continued
 List of selected first order weather
 stations selected to test the EPIC
 climate generator, with longitude and
 latitude in degrees and hundreths

Station	Longi- tude	Lati- tude	Period of record ¹
Milwaukee, WI	87.54	42.57	17
Minneapolis, MN	93.22	44.88	33
Mobile, AL	80.15	30.41	16
Montgomery, AL	86.24	32.18	85
Mt. Shasta, CA	122.32	41.32	27
Mount Washington, NH	71.18	44.16	25
Nantucket, MA	70.04	41.15	43
Nashville, TN	86.68	36.12	87
Newark, NJ	74.17	40.70	13
New Orleans, LA	90.06	29.95	87
New York, NY	73.58	40.47	103
Norfolk, VA	76.12	36.54	22
North Platte, NE	100.41	41.08	6
Oklahoma City, OK	97.60	35.40	30
Olympia, WA	122.54	46.58	23
Pendleton, OR	118.51	45.41	22
Philadelphia, PA	75.15	39.53	28
Phoenix, AZ	112.01	33.26	28
Pittsburgh, PA	80.22	40.50	18
Pocatello, ID	112.36	42.55	21
Portland, ME	70.32	43.65	31
Portland, OR	122.67	45.53	55
Providence, RI	71.43	41.73	53
Pueblo, CO	104.31	38.17	27
Raleigh, NC	78.78	35.87	25
Rapid City, SD	103.05	34.03	15
Richmond, VA	77.33	37.50	33
Roswell, NM	104.32	33.24	24
ST. Louis, MO	90.23	38.45	11
Salem, OR	123.01	44.55	20
Salt Lake City, UT	111.97	40.76	29
San Antonio, TX	98.28	29.32	26
San Diego, CA	117.10	32.44	29
San Francisco, CA	122.42	37.78	33
Savanah, GA	81.20	32.13	18
Scottsbluff, NE	103.36	41.52	15
Sexton Summit, OR	123.22	42.37	16
Shreveport, LA	93.49	32.28	6
Stampede Pass, WA	121.20	47.17	21

Table 4.1--Continued
 List of selected first order weather
 stations selected to test the EPIC
 climate generator, with longitude and
 latitude in degrees and hundreths

Station	Longi- tude	Lati- tude	Period of record ¹
Syracuse, NY	76.07	43.07	22
Tallahassee, FL	84.22	30.23	11
Tampa, FL	82.32	27.58	25
Toledo, OH	83.48	41.36	87
Topeka, KS	95.38	39.04	11
Tulsa, OK	95.54	36.12	31
Waco, TX	97.13	31.37	26
Walla Walla, WA	118.20	46.02	50
Washington, DC	77.05	38.90	87
Wichita, KS	97.25	37.39	4
Williston, ND	103.62	48.15	41
Wilmington, DE	75.60	39.67	10
Winnemucca, NV	117.48	40.54	87
Yakima, WA	120.32	46.34	18
Yuma, AZ	114.60	32.67	15

¹ Records maintained at the National Weather
 Data Center, Ashville, NC.

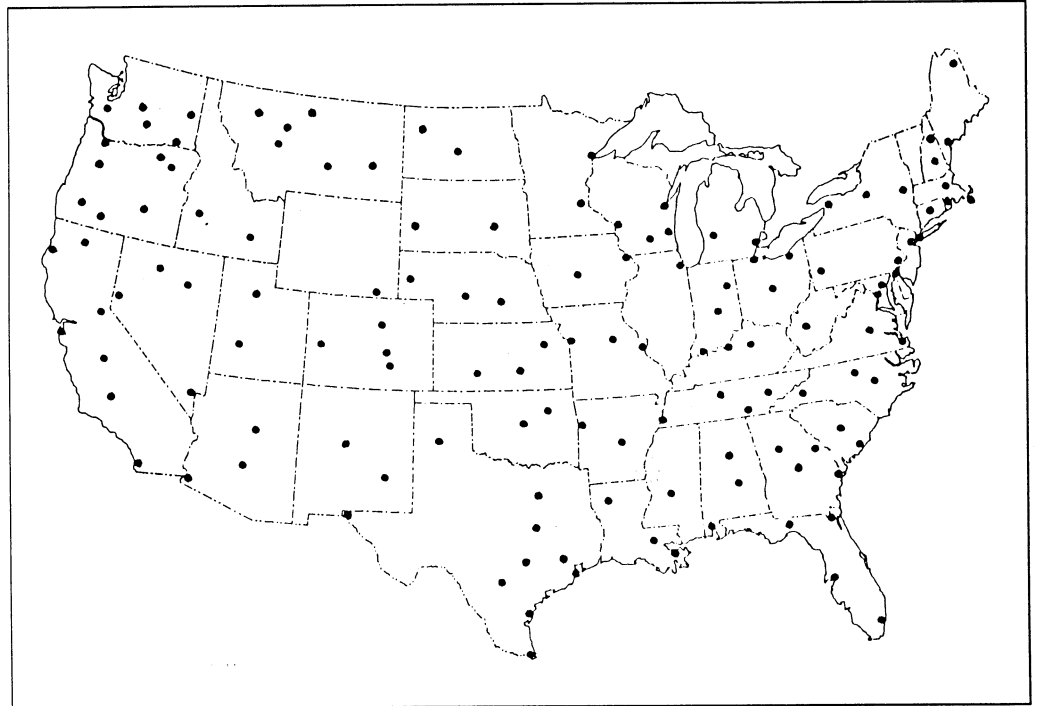

Figure 4.1
Locations of first order weather station used in testing EPIC
weather generating model.

A two-sided t-test was used to test whether the simulated means were significantly different from the period and normal means for total monthly precipitation; monthly mean, maximum, and minimum temperatures; and monthly mean total solar radiation. Values obtained from the simulations but not submitted to rigorous statistical testing were extreme values of daily precipitation, temperature, and solar radiation, as well as the number of days of precipitation during the month.

A program was written to both generate and statistically evaluate the weather data for each of the selected stations. This mainline program in conjunction with other component models of EPIC provide for inputting the required data to generate the weather values.

Sample input data for weather simulation, input data for the statistical evaluation of simulated weather, and output of statistical data are presented in tables 4.2-4.4 for the Jackson, MS, station.

Table 4.2
 Example of input, consisting of parameters
 and Fourier coefficients, required to
 generate daily rainfall, maximum and
 minimum air temperatures, and solar radation

JACKSON, MISSISSIPPI

STAT. LAT.= 32.33 LONG.= 90.22 YEARS OF OBS= 18

-MO RAIN PROB-		-MO STATS FOR DAILY RAIN-		
W/D	W/W	MEAN	ST DV	SKW CF ¹
.516	.262	.385	.518	2.438
.454	.287	.434	.504	1.754
.458	.258	.482	.595	1.940
.364	.267	.551	.790	2.665
.539	.170	.530	.682	2.413
.450	.205	.402	.564	2.598
.451	.289	.391	.541	3.420
.394	.246	.393	.532	2.491
.429	.174	.456	.750	2.871
.396	.126	.413	.820	5.611
.389	.217	.431	.600	3.084
.488	.267	.493	.564	1.476

FOURIER COEFS(MEAN, AMPLITUDE)

MAX TEMP CLEAR ²	=	24.44	10.56
MAX TEMP RAIN ³	=	23.06	10.56
COEF OF VAR MAX TEMP ⁴	=	.12	-.08
MIN TEMP ⁵	=	12.67	10.28
COEF OF VAR MIN TEMP ⁶	=	.17	-.12
SOL RAD CLEAR ⁷	=	450.	180.
SOL RAD RAIN ⁸	=	268.	180.

- ¹ W/D - Probability of dry day, given previous wet day.
 W/W - Probability of wet day, given previous wet day.
 MEAN - Mean daily rainfall (inches).
 ST DV - Standard deviation of daily rainfall (inches).
 SKW CF - Skew coefficient of daily rainfall (inches).
- ² Maximum mean temperature (°C) on clear days.
- ³ Maximum mean temperature (°C) on rainy days.
- ⁴ Coefficient of variation of maximum temperature.
- ⁵ Minimum mean temperature (°C).
- ⁶ Coefficient of variation of minimum temperature.
- ⁷ Mean solar radiation on clear days.
- ⁸ Mean solar radiation on rainy days.

Table 4.3

Example of inputs, consisting of period (M) and normal (N) means to statistically evaluate the simulated means for the Jackson, MS, station (lat. = 32.33, long. = 90.22)

Month	Temperature ($^{\circ}$ C)										Month	
	Maximum		Minimum		Daily		Amount of rain (mm)		Solar radiation (ly)			No.day rain
	M	N	M	N	M	N	M	N	M	N		
J	13.33	14.78	2.40	3.28	7.86	9.03	124.7	129.3	212.3	221.0	12.8	
F	14.52	16.93	3.53	4.67	90.02	18.53	124.4	129.3	275.5	273.0	11.3	
M	18.13	20.06	7.04	7.50	12.59	13.78	144.9	158.2	362.9	350.0	11.8	
A	23.50	24.44	12.19	12.06	17.84	18.25	139.3	122.4	465.5	452.0	10.0	
M	28.68	28.72	17.32	16.00	23.00	22.36	164.3	103.9	524.9	571.0	12.2	
J	32.84	33.0	21.33	20.17	27.09	26.58	110.7	94.5	563.5	562.0	10.8	
J	34.45	34.22	22.93	21.39	28.69	27.81	119.5	117.1	542.9	573.0	12.0	
A	33.32	33.94	21.78	20.94	27.55	27.44	106.2	83.3	490.2	524.0	10.6	
S	29.54	31.50	18.09	18.17	23.81	24.83	118.8	53.3	401.1	542.0	10.3	
O	24.43	26.50	13.08	11.72	18.75	19.11	101.4	55.4	316.2	369.0	9.7	
N	18.98	19.56	7.08	6.17	13.39	12.86	109.0	102.9	240.5	263.0	10.0	
D	14.95	15.22	3.97	3.67	9.46	9.44	155.1	142.2	197.8	219.0	12.4	

Period means based on 18 yr of record; normal means based on data reported over 1931-60.

Table 4.4

Example of test program output listing the two sided t-test results for simulated means vs. period means and normal means of monthly rainfall in inches

Run	Months											
	J	F	M	A	M	J	J	A	S	O	N	D
1	134.84	124.54	169.17	168.31	209.40	116.17	134.36	93.53	106.30	76.92	140.98	180.31
2	152.01	122.03	150.75	130.52	158.42	95.64	121.17	92.41	90.89	95.67	102.28	147.78
3	126.61	176.23	167.20	149.98	139.29	123.31	115.01	116.83	115.86	108.37	134.32	163.78
4	125.05	116.65	131.51	132.59	216.04	106.01	135.39	119.12	114.19	56.74	103.49	167.59
5	178.83	123.46	120.59	127.48	153.34	128.19	119.63	126.17	112.07	107.19	94.44	155.32
6	111.53	139.45	139.27	156.67	112.77	116.13	136.12	84.27	106.10	78.96	113.35	161.36
7	130.28	107.19	159.21	150.02	159.70	161.40	100.75	86.35	128.61	88.43	94.00	137.42
8	125.35	146.43	150.78	133.85	208.45	117.44	134.68	126.73	103.72	79.87	132.13	134.33
9	139.02	132.27	135.08	186.11	149.84	100.45	118.30	92.37	137.97	89.24	88.31	145.74
10	106.54	129.04	165.30	103.61	146.43	100.23	116.42	92.35	132.13	82.32	110.79	163.77

Period mean test.

MEAN ¹	133.01	131.73	148.88	143.91	165.37	116.50	123.18	103.01	114.78	86.37	111.41	155.74
ST.D ²	61.91	57.51	50.16	70.12	103.12	57.16	35.07	51.06	43.35	45.80	55.71	43.16
SD.M ³	19.58	18.19	15.86	22.17	32.61	18.08	11.09	16.15	13.71	14.48	17.62	13.65
CR.U ⁴	44.28	41.14	35.88	50.16	73.76	40.89	25.08	36.52	31.01	32.76	39.85	30.87
DIFF ⁵	8.27	7.36	4.03	4.60	1.06	5.78	3.69	-3.19	-4.00	-15.03	2.40	.59
OB.R ⁶	124.74	124.37	144.85	139.32	164.31	110.72	119.49	106.20	118.78	101.40	109.01	155.15
	0.	0.	0.	0.	0.	0.	0.	0.	0.	0.	0.	0.

Run	Months											
	J	F	M	A	M	J	J	A	S	O	N	D
MEAN ₁	133.01	131.73	148.88	143.91	165.37	116.50	123.18	103.01	114.78	86.37	111.41	155.74
ST.D ²	61.91	57.51	50.16	70.12	103.12	57.16	35.07	51.06	43.35	45.80	55.71	43.16
SD.M ³	19.58	18.19	15.86	22.17	32.61	18.08	11.09	16.15	13.71	14.48	17.62	13.65
CR.U ⁴	44.28	41.14	35.88	50.16	73.76	40.89	25.08	36.52	31.01	32.76	39.85	30.87
DIFF ⁵	3.72	2.44	-9.36	21.49	61.48	22.01	6.09	19.70	61.44	31.00	8.54	13.50
OB.R ⁶	129.29	129.29	158.24	122.43	103.89	94.49	117.09	83.31	53.34	55.37	102.87	142.24
	0.	0.	0.	0.	0.	0.	0.	0.	1.	0.	0.	0.

1 - SIGNIFICANT. 0 - NONSIGNIFICANT

- ¹ Mean monthly rainfall.
- ² Standard deviation of monthly rainfall.
- ³ Standard deviation of the mean.
- ⁴ Critical difference for t0.05.
- ⁵ Difference between observed and simulated means.
- ⁶ Observed period or normal mean of monthly rainfall.

Table 4.4 illustrates the type of data generated and the general method of testing the data against the period and normal means. Listed first are the mean monthly values of rainfall for each 10-year run. These are averaged, and the averages shown in a row, after the word MEAN. Listed next are the standard deviation and standard deviation of the means for the runs, along with the critical difference at $t_{0.95} = 2.262$ and the difference between the observed and the generated means. This last difference is compared to the critical difference (U). If the resulting difference is larger than U, the test fails. Failure is noted by "1," which is listed under the appropriate months in the line following the OB.R values. Similar tests were made for monthly total solar radiation and maximum, minimum, and mean daily temperatures.

RESULTS

For most of the 134 stations, table 4.5 shows the number of months that the simulated means of precipitation (Rain); maximum (Tmax), minimum (Tmin), and average air temperatures (Tave); and solar radiation (Sol.rad) differed significantly from the corresponding period and normal means as shown by the t-tests. For example, reading left to right under the weather variables in the table, the simulated means for the Albuquerque, NM, location were significantly different from the period means for 0, 0, 1, 2, and 9 months and from the normal means for 7, 9, 9, 9, and 12 months.

A summary of all stations combined is presented in table 4.6, where the tests on period means have been composited to show the number of stations failing the significance test at the number of months shown. For example, there were 5, 35, 81, 71 and 81 stations for each of the weather variables, respectively, which had failed the test during one or more months during the year.

Table 4.5
 Number of months that simulated data on
 rain, temperature, and solar radiation differed
 significantly ($p = 0.05$) from the corresponding
 period mean (M) and normal mean (N)

Station	Rain		Tmax		Tmin		Tave		Sol. rad	
	M	N	M	N	M	N	M	N	M	N
Albany, NY	0	0	2	12	0	11	0	9	3	9
Albuquerque, NM	0	7	0	9	1	9	2	9	9	12
Amarillo, TX	0	9	0	9	1	10	1	10	1	10
Asheville, NC	0	2	0	9	2	12	0	12	0	11
Atlanta, GA	0	3	0	7	3	9	0	7	0	6
Augusta, GA	0	6	0	10	1	8	0	8	0	7
Austin, TX	0	3	0	8	0	8	0	9	0	11
Bakersfield, CA	0	10	0	9	2	12	4	12	0	10
Baltimore, MD	0	3	0	12	1	11	1	7	2	10
Baton Rouge, LA	0	1	0	8	0	8	0	8	0	11
Billings, MT	0	7	0	11	1	11	1	8	0	12
Birmingham, AL	0	2	0	7	1	10	0	9	0	10
Bismarck, ND	0	5	0	9	2	4	2	5	1	7
Blue Canyon, CA	0	7	0	12	3	12	5	11	1	11
Boise, ID	0	7	1	10	0	9	4	8	0	11
Boston, MA	0	2	2	8	1	11	3	7	0	12
Brownsville, TX	0	5	0	6	0	10	0	10	0	8
Buffalo, NY	0	0	3	11	0	9	3	8	0	8
Burns, OR	0	9	0	8	1	12	3	12	3	8
Caribou, ME	0	1	0	8	0	9	3	9	3	6
Charleston, SC	0	2	0	9	1	9	0	7	0	9
Charleston, WV	0	0	0	9	0	9	1	9	2	12
Chattanooga, TN	0	1	0	7	3	10	0	9	0	4
Cheyenne, WY	1	2	1	12	3	9	0	9	0	11
Chicago, IL	0	2	3	9	2	12	2	12	1	11
Cleveland, OH	0	0	1	5	0	8	0	10	3	7
Colorado Springs, CO	0	7	0	9	1	10	0	12	0	11
Columbia, MO	0	0	0	7	3	11	1	10	1	6
Columbia, SC	0	3	0	11	3	7	0	11	0	7
Columbus, OH	0	0	0	4	0	5	2	7	0	7
Concord, NH	0	0	3	8	0	12	3	9	0	10
Corpus Christi, TX	0	5	0	6	12	12	1	11	12	12
Dallas, TX	0	5	0	6	3	11	0	12	0	10

Table 4.5--Continued
 Number of months that simulated data on rain,
 temperature, and solar radiation differed
 significantly ($p = 0.05$) from the corresponding
 period mean (M) and normal mean (N)

Station	Rain		Tmax		Tmin		Tave		Sol. rad	
	M	N	M	N	M	N	M	N	M	N
Denver, CO	0	7	0	10	2	9	2	8	1	11
Des Moines, IA	0	1	1	8	0	5	1	8	2	9
Detroit, MI	0	0	3	9	2	11	3	6	0	11
Dodge City, KS	0	6	0	3	1	8	0	11	0	9
Dubuque, IA	0	5	2	9	1	7	2	6	1	10
Duluth, MN	0	0	0	11	2	7	3	9	3	9
Elko, NV	0	7	0	10	0	12	0	12	3	11
El Paso, TX	0	10	0	8	3	10	12	11	0	7
Eureka, CA	0	4	0	11	4	10	0	12	7	10
Evansville, IN	0	1	0	7	0	9	1	10	1	6
Flagstaff, AZ	0	8	0	12	3	12	0	12	4	12
Fort Smith, AR	0	4	0	8	2	8	0	9	1	4
Fort Wayne, IN	0	1	1	8	0	7	0	7	3	9
Fresno, CA	1	11	0	11	3	10	0	11	4	12
Galveston, TX	2	5	0	12	0	12	0	4	0	11
Grand Island, NE	0	6	0	9	1	6	0	5	1	8
Grand Junction, CO	0	8	0	10	0	8	0	10	3	12
Grand Rapids, MI	0	1	2	10	1	8	2	9	3	8
Great Falls, MT	0	6	0	10	2	7	1	8	3	11
Green Bay, WI	0	3	0	7	1	7	1	7	3	8
Greensboro, NC	0	2	0	6	2	10	0	5	1	7
Hartford, CT	0	2	1	10	1	12	3	5	2	9
Harve, MT	0	6	0	9	2	10	1	9	2	12
Helena, MT	0	6	0	9	1	12	0	7	1	11
Houston, TX	0	4	0	5	0	3	0	5	0	10
Huron, SD	0	3	0	10	0	7	1	6	1	10
Indianapolis, IN	0	3	0	7	2	8	2	4	0	8
Jackson, MS	0	1	0	7	0	9	0	7	0	6
Jacksonville, FL	0	2	0	11	0	6	0	7	0	10
Kalispell, MT	0	3	0	8	1	11	0	10	3	12
Kansas City, MO	0	4	0	7	2	12	0	7	0	11
Knoxville, TN	0	1	0	7	2	9	0	7	1	5
La Crosse, WI	0	1	0	9	1	8	2	9	2	7
Las Vegas, NV	0	10	0	12	2	12	4	12	0	12
Lexington, KY	0	0	0	8	0	7	2	8	1	11
Little Rock, AR	0	3	0	8	3	8	0	4	0	8
Louisville, KY	0	1	0	6	0	8	1	11	2	8

Table 4.5--Continued
 Number of months that simulated data on rain,
 temperature, and solar radiation differed
 significantly ($p = 0.05$) from the corresponding
 period mean (M) and normal mean (N)

Station	Rain		Tmax		Tmin		Tave		Sol. rad	
	M	N	M	N	M	N	M	N	M	N
Macon, GA	0	3	0	11	0	8	0	9	0	11
Madison, WI	0	2	2	9	1	6	2	8	2	7
Meacham, OR	0	5	2	11	0	12	1	12	4	12
Medford, OR	0	7	0	9	3	12	1	8	6	7
Memphis, TN	0	6	0	7	3	9	0	8	1	3
Miami, FL	0	2	0	7	1	11	0	5	0	11
Miles City, MT	0	7	0	12	1	8	1	10	1	9
Milford, UT	0	9	0	9	0	11	0	11	4	10
Milwaukee, WI	0	3	2	10	1	11	2	10	3	8
Minneapolis, MN	0	2	1	8	1	6	2	8	2	5
Mobile, AL	1	1	0	9	0	9	0	7	0	7
Montgomery, AL	0	3	0	11	0	10	0	9	0	9
Mount Shasta, CA	0	9	0	11	3	12	7	10	1	12
Mt. Washington, NH	0	12	2	12	3	12	1	12	4	10
Nantucket, MA	0	1	1	10	1	12	1	11	3	8
Nashville, TN	0	5	0	7	1	10	1	4	1	8
Newark, NJ	0	1	0	6	0	11	2	10	3	8
New Orleans, LA	0	0	0	8	0	12	0	11	0	12
New York, NY	0	1	0	8	1	10	3	6	2	10
Norfolk, VA	0	2	0	10	2	12	0	12	1	5
North Platte, NE	0	7	0	9	2	7	1	9	0	6
Oklahoma City, OK	0	5	0	10	0	10	0	11	0	7
Olympia, WA	0	4	1	11	0	12	4	12	5	11
Pendleton, OR	0	4	1	10	0	12	1	11	4	12
Philadelphia, PA	0	1	0	9	0	10	2	8	2	5
Phoenix, AZ	0	11	0	12	3	10	0	9	6	11
Pittsburgh, PA	0	0	1	5	0	7	3	12	0	7
Pocatello, ID	0	5	1	9	0	7	0	8	2	6
Portland, ME	0	0	2	10	2	12	3	9	1	9
Portland, OR	0	5	0	11	0	12	6	10	3	11
Providence, RI	0	1	1	11	1	11	3	7	2	10
Pueblo, CO	0	5	0	11	0	11	0	8	2	10
Raleigh, NC	0	4	0	10	3	10	0	7	0	7
Rapid City, SD	0	3	1	8	2	7	1	10	1	9
Richmond, VA	0	3	0	12	1	9	1	9	1	12
Roswell, NM	0	8	0	12	2	12	0	11	7	11

Table 4.5--Continued
 Number of months that simulated data on rain,
 temperature, and solar radiation differed
 significantly ($p = 0.05$) from the corresponding
 period mean (M) and normal mean (N)

Station	Rain		Tmax		Tmin		Tave		Sol. rad	
	M	N	M	N	M	N	M	N	M	N
St. Louis, MO	0	2	0	7	1	10	1	10	1	6
Salem, OR	0	3	0	11	1	11	3	11	5	11
Salt Lake City, UT	0	5	1	7	0	11	4	8	0	10
San Antonio, TX	0	4	0	8	0	8	0	7	0	10
San Diego, CA	0	10	0	12	3	11	0	12	3	10
San Francisco, CA	0	9	0	11	3	12	0	11	5	7
Savanah, GA	0	3	0	9	0	8	0	7	0	8
Scottsbluff, NE	0	7	1	10	1	8	1	8	0	9
Sexton Summit, OR	0	4	0	11	3	11	1	12	7	9
Shreveport, LA	0	4	0	7	0	8	0	8	0	7
Stampede Pass, WA	0	4	1	12	0	12	2	12	4	10
Syracuse, NY	0	1	3	8	0	7	0	8	3	7
Tallahassee, FL	0	3	0	9	0	7	0	7	0	7
Tampa, FL	0	4	0	11	0	8	0	10	0	9
Toledo, OH	0	0	2	10	1	10	0	6	2	8
Topeka, KS	0	2	0	9	2	8	0	8	0	6
Tulsa, OK	0	3	0	10	0	9	0	7	0	10
Waco, TX	0	6	0	8	0	8	0	8	0	11
Walla Walla, WA	0	3	1	11	0	12	1	12	4	9
Washington, DC	0	0	0	11	1	11	1	8	2	12
Wichita, KS	0	6	0	10	0	10	1	10	0	11
Williston, ND	0	3	0	9	2	6	2	8	1	5
Wilmington, DE	0	1	0	10	1	8	2	9	1	7
Winnemucca, NV	0	9	0	9	1	12	3	12	3	11
Yakima, WA	0	12	1	11	0	11	3	12	3	11
Yuma, AZ	1	11	2	12	3	12	4	8	2	12

Table 4.6
 Summary of test run results listing
 the number of stations at the indicated
 number of months for which simulated values
 tested against the period means failed the
 significance test ($p=0.05$)

Number of months	Number of stations				
	Rain	Tmax	Tmin	Tave	Sol. rad.
0	5	35	81	71	81
1	1	10	45	43	55
2	0	5	23	25	38

Other comparisons were made using the data generated from the climate model. These include monthly snowfall listed in table 4.7 and daily extreme values for precipitation and temperature in table 4.8. Snow is not generated directly in the climate model. However, any precipitation generated for days when the average temperature is at or below 0°C is considered by EPIC to be snow. These accumulations are then subject to snowmelt according to a snowmelt component model of EPIC. Comparison of simulated and observed snow data is complicated by the fact that snow is usually observed and reported as depth of accumulation on the ground. The weather model, however, generates values for these accumulations in terms of equivalent depth of rainfall. Therefore, direct comparisons between, observed and simulated snow amounts were made for only at those stations with mean daily temperature at or below 0°C for the months of January, February, and December table 4.7. Usually, the agreement between observed and simulated amounts was close.

DISCUSSION

In general, the weather generator in EPIC does a remarkable job in generating mean daily rainfall, as shown by the results of comparisons with period means. It does less well on maximum temperature, solar radiation, and minimum temperature, in descending order. Average daily temperature is calculated from maximum and minimum values and, therefore, is not readily comparable; i.e., poor agreement between the generated and period means for only one of the last two weather variables can affect the agreement between the average temperatures.

Inspection of table 4.5 shows that the generated data, derived from the period of record available on tape (generally, 1951-70) do not agree closely with the published normal values (1931-60). A similar conclusion can be drawn from table 4.7. There are several reasons for the discrepancies between the simulated and published normal values. As stated previously, the normals are from a different period of record than the period used to derive the generator parameters. Furthermore, the critical differences, as given as examples in table 4.4, were very small for variables such as temperature; therefore, the margin for significance was exceeded in many cases by a very small amount (1°C). Also, the best results might more closely match published normals if for each station, the period of generation were adjusted so that it equaled the number of years for which data were used to calculate the normal means. More research and investigation of this procedure is warranted to extend the application of the generator.

CONCLUSIONS

Overall, the generator is judged to be adequate for the weather generating task required by EPIC, considering that it performs well in generating precipitation amount and sequence, maximum temperature, and solar radiation. In less than 10 % of the cases for rainfall and maximum air temperature, only 3 months or less were significantly different from the period mean for these variables. Therefore, it should be considered to generate representative data for the period. In addition, the generator development and associated compilation of parametric values make it readily available for the user of EPIC and other similar models which require daily weather data.

Table 4.7
 Observed and simulated amounts (mm) of snow for
 winter months at selected stations

Station	January		February		December	
	Ob.	Sm.	Ob.	Sm.	Ob.	Sm.
Albany, NY	62.70	51.60	55.90	50.78	65.80	52.04
Billings, MT	13.70	21.93	15.20	22.65	15.00	24.24
Bismarck, ND	9.10	13.69	10.90	14.79	10.20	13.88
Boise, ID	33.50	37.60	33.80	25.75	33.50	27.67
Boston, MA	100.10	89.86	84.30	87.41	92.20	93.77
Buffalo, NY	72.10	52.85	69.20	47.64	76.20	57.72
Burns, OR	37.30	42.79	31.20	22.78	36.60	24.03
Caribou, ME	53.60	44.37	51.30	52.70	61.70	66.04
Cheyenne, WY	14.20	11.78	16.50	5.79	13.20	11.72
Chicago, IL	47.20	39.83	40.60	34.56	48.30	46.03
Charleston, WV	101.30	35.58	88.90	37.45	75.70	30.40
Cleveland, OH	60.50	52.87	53.80	38.15	58.20	37.82
Colorado Springs, CO	7.40	11.80	8.40	12.79	6.10	10.75
Columbia, MO	43.40	36.23	46.00	28.49	49.80	19.65
Corpus Christi, TX	41.40	18.44	43.20	25.44	52.80	21.72
Columbus, OH	74.70	40.13	57.70	35.02	63.20	28.84
Concord, NH	73.90	58.49	58.40	68.25	71.40	84.30
Des Moines, IA	33.00	23.52	27.90	26.63	29.00	22.94
Denver, CO	14.00	20.16	17.50	24.19	11.90	17.49
Detroit, MI	52.10	41.97	52.80	39.48	52.80	42.49
Dodge City, KS	12.40	13.96	19.80	14.76	12.70	14.91
Dubuque, IA	46.50	30.41	35.60	32.85	48.30	45.43
Duluth, MN	29.20	25.47	24.40	21.98	29.50	31.14
Elko, NV	27.20	34.02	24.10	21.15	26.70	29.52
Fort Wayne, IN	64.50	52.35	45.00	42.87	57.40	42.49
Grand Island, NE	14.70	22.12	16.80	22.98	14.00	21.40
Grand Junction, CO	16.30	20.53	17.50	18.58	14.50	16.56
Grand Rapids, MI	48.50	36.96	44.40	33.16	51.60	43.50
Green Bay, WI	32.80	24.14	34.50	25.20	32.00	27.42
Hartford, CT	80.00	67.98	65.30	61.71	83.60	62.40
Havre, MT	12.40	15.80	10.90	14.03	11.90	14.95
Helena, MT	11.90	16.22	10.90	13.46	13.50	18.52
Huron, SD	14.50	9.02	12.40	26.63	11.40	17.39
Indianapolis, IN	80.00	61.95	52.80	41.46	70.90	38.37
Kalispell, MT	34.80	32.43	25.40	23.89	33.80	30.17
Kansas City, MO	35.80	32.44	31.50	16.66	38.90	14.19
La Crosse, WI	31.00	18.63	28.20	26.71	31.00	23.59

Table 4.7--Continued
 Observed and simulated amounts (mm) of snow for
 winter months at selected stations

Station	January		February		December	
	Ob.	Sm.	Ob.	Sm.	Ob.	Sm.
Madison, WI	33.30	24.54	28.70	27.61	35.60	36.81
Meachum, OR	107.70	86.49	103.10	65.00	11.30	74.20
Miles City, MT	11.20	14.99	9.40	18.66	9.40	17.97
Milford, UT	14.50	21.07	18.00	21.34	19.00	19.77
Milwaukee, WI	40.10	34.48	32.30	26.93	37.60	37.86
Minneapolis, MN	17.80	17.28	19.80	27.36	21.80	24.50
Mt. Washington, NH	73.90	120.89	58.40	141.88	71.40	128.94
Nantucket, MA	107.20	89.03	95.50	78.28	99.80	69.42
Newark, NJ	84.60	55.83	71.10	28.39	81.80	21.74
New York, NY	84.10	52.49	72.10	26.04	82.80	15.95
North Platte, NE	9.90	14.33	8.60	21.11	10.20	13.78
Olympia, WA	199.40	155.31	168.10	94.99	229.90	102.51
Pendleton, OR	37.60	37.76	35.60	27.75	42.90	28.31
Philadelphia, PA	84.30	53.56	71.10	12.93	74.70	13.74
Pittsburgh, PA	75.40	55.12	55.60	33.68	61.00	28.66
Pocatello, ID	30.70	23.65	23.40	20.27	25.40	24.60
Portland, ME	111.00	81.77	96.50	99.06	97.80	99.83
Portland, OR	137.90	115.30	123.70	48.89	180.30	58.49
Providence, RI	95.20	84.56	72.10	79.68	87.60	69.66
Pueblo, CO	7.90	12.38	12.20	11.74	7.60	14.48
Rapid City, SD	12.20	12.49	8.10	21.16	8.60	14.75
Saint Louis, MO	50.30	36.23	51.80	18.81	50.00	15.64
Salem, OR	145.30	138.72	135.10	55.80	180.80	58.71
Salt Lake City, UT	30.50	32.14	31.20	35.76	34.00	39.61
Scottsbluff, NE	20.80	12.99	23.40	13.00	21.80	16.65
Spokane, WA	62.00	57.45	47.20	39.70	61.70	51.42
Stampede Pass, WA	305.60	232.69	257.80	184.53	411.20	199.08
Syracuse, NY	80.00	51.99	79.50	60.09	80.00	55.70
Toledo, OH	57.10	48.91	47.20	39.11	58.20	37.82
Topeka, KS	27.20	22.98	24.60	18.04	29.50	23.83
Walla Walla, WA	48.00	48.52	38.60	32.52	47.00	42.04
Williston, ND	12.40	15.45	11.70	16.18	13.70	16.01
Wilmington, DE	90.40	33.56	75.70	38.81	75.90	48.62
Winnemucca, NV	24.40	29.90	25.70	14.27	25.40	12.32
Yakima, WA	30.20	39.24	22.10	28.91	28.40	29.07

Table 4.8
 Simulated and observed daily extreme weather values, Jackson, MS

	Month											
	J	F	M	A	M	J	J	A	S	O	N	D
Simulated Max. Temperature (C)	23.50	23.94	31.66	33.83	37.55	39.84	39.36	39.05	37.82	34.39	30.17	25.24
Observed Max. Temperature (C)	29.44	27.78	31.11	33.89	37.22	39.44	40.00	41.44	39.44	35.56	30.00	28.89
Simulated Min. Temperature (C)	.56	.69	1.84	4.98	10.37	15.48	19.79	16.15	10.52	5.59	2.54	.70
Observed Min. Temperature (C)	-20.56	-17.22	-8.33	-1.11	5.66	8.89	13.89	12.22	5.00	-2.22	-7.78	-8.89
Simulated Max. Rainfall (mm)	162.56	81.28	105.41	183.39	155.70	132.59	133.60	133.35	126.75	191.26	134.37	110.74
Observed Max. Rainfall (mm)	110.49	102.11	96.27	123.19	117.60	121.41	87.88	113.79	72.39	48.51	10.85	190.50

REFERENCES

- Nicks, A.D. 1974. Stochastic generation of the occurrence, pattern, and location of maximum amount of daily rainfall. Proc. Symp. on Statistical Hydrology, U.S. Dep. Agric., Agric. Res. Ser., Misc. Publ. 1975. pp. 154-171.
- Nicks, A.D. 1975. Stochastic Generation of Hydrologic Model Inputs. Ph. D. Dissertation, University of Oklahoma, Norman, OK.
- Nicks, A.D. and Harp, J.R. 1980. Stochastic generation of temperature and solar radiation data. 48:1-17.
- Richardson, C.W. 1981. Stochastic simulation of daily temperature, and solar radiation. Water Resour. Res. 17:182-190.
- Water Information Center, Inc. 1974. Climate of the States. Vol. 1. Eastern States. Port Washington, NY. 479 pp.
- Williams, J.R., P.T. Dyke, and C.A. Jones. 1982. EPIC: A model for assessing the effects of erosion on soil productivity. Proceedings of Symposium on Chemical Transport. Ft. Collins, CO. March, 1982. 75 pp.

5. COMPUTATION OF UNIVERSAL SOIL LOSS EQUATION R AND C FACTORS FOR SIMULATING INDIVIDUAL-STORM SOIL LOSS

J. M. Laflen G. R. Foster and C.A. Onstad

ABSTRACT

Equations, data, and methods are given for computing the rainfall and crop management factors needed to simulate individual-storm soil loss with the Universal Soil Loss Equation. The methodology for calculating C-values is expected to be incorporated into EPIC.

INTRODUCTION

Soil erosion predictions for individual storms (Williams 1983) will be made by EPIC through the use of the Universal Soil Loss Equation (USLE). To improve the accuracy of the predictions, slightly different versions of the USLE rainfall and runoff factor (R) and cover-management factor (C) will be used by EPIC. Soil erodibility, slope-length, and conservation-practice factors, however, will be the values commonly used in the USLE. The new C-values will be based on functions of interactive relationships of soil, surface, and crop conditions. These functions will be computed from the production, tillage, and residue management outputs of other component models of EPIC.

The soil erosion prediction component of EPIC is still undergoing development and testing. This chapter describes the equations we propose for increasing the accuracy of EPIC to estimate rainfall-induced soil erosion. Not included is a discussion of the wind-erosion component and erosion caused by irrigation or snowmelt.

Units used in this chapter are those given by Foster et al. (1981) for SI units. Units for R and C are such that soil loss as computed by EPIC is in tons per hectare.

MODIFICATION OF THE USLE RAINFALL AND RUNOFF FACTOR

The USLE is designed to predict long-term annual soil losses and is not recommended for predicting soil losses due to individual events (Wischmeier and Smith 1978). A major weakness of the USLE for short-term soil loss predictions, is the failure of its R-value, referred to in this chapter as "rainfall erosivity factor", to adequately account for hydrologic conditions, particularly antecedent conditions as they affect the peak rate and total volume of surface runoff. Williams (1975), Onstad and Foster (1975), and Foster et al. (1977) evaluated modifications of the USLE rainfall erosivity factor so that individual-storm soil loss predictions may be improved. Because EPIC's hydrologic component model provides estimates of total volume

and peak rate of surface runoff, for individual storms, an opportunity arose to improve the corresponding soil loss predictions.

Williams's (1975) replacement for the USLE erosivity factor (R_w) can be expressed as

$$R_w = 27.06A^{0.12} Q^{0.56} q_p^{0.56} \quad [5.1]$$

where A is watershed area (ha), Q is the volume of runoff (mm), and q_p is peak flow rate (mm/h). The equation was derived by using watershed sediment yield; hence, the erosivity factor of Williams also expresses the effect of a delivery ratio. When used with Williams' erosivity replacement, USLE is named MUSLE (Modified Soil Loss Equation).

The replacement for the erosivity factor (R_o) in the Onstad-Foster modification of USLE (OF) can be expressed as

$$R_o = 0.5R + 3.42 Q q_p^{1/3} \quad [5.2]$$

where R is the usual USLE rainfall erosivity factor in SI units (Foster et al. 1981), and is the product of storm rainfall energy (E) and maximum 30-minute rainfall intensity (I). Q and q_p are as in equation 5.1.

The variables in equations 5.1 and 5.2 are expressed in the SI system of units, as recommended by Foster et al. (1981). When the English system of units is used, and Q is in inches, q_p in in/h, A in acres, and R is the product of E (cft.tons/acre) and I (in/h), the constant 27.06 in equation 5.1 is 53.41 and the constant 3.42 in equation 5.2 is 15.00.

A major difference between OF and MUSLE is that MUSLE does not include a rainfall variable, even though it is well recognized that rainfall energy is important in soil erosion (Young and Wiersma 1973). In the absence of runoff, MUSLE will not predict soil loss whereas OF will predict half the amount of soil loss predicted by the USLE. If runoff volume and/or runoff rates are large relative to rainfall erosivity, as they might be when antecedent moisture conditions are high and/or the soils are impermeable and have little water-holding capacity, MUSLE soil loss predictions may exceed those of OF.

Another major difference between OF and MUSLE is that MUSLE relates sediment yield to watershed area. A cursory examination of equation 5.1 would suggest that sediment yield, which varies directly with R_w in MUSLE, will increase as watershed area increases, a contradiction of much of the published literature.

However, as watershed area increases, both Q and q_p usually decrease at a rate such that Williams' erosivity factor and predicted sediment yield should decrease.

If runoff erosivity relative to rainfall erosivity is low, individual-storm soil loss predicted by OF or MUSLE should be lower than that predicted by USLE. If runoff erosivity is large relative to rainfall erosivity, soil loss predicted by either OF or MUSLE should be greater than that predicted by USLE. Values of R_w and R_o calculated for several runoff rates are mutually compared with three R values in figures 5.1 - 5.3.

There has been considerable debate as to which soil loss equation to use. Most of the debate has centered on what estimate is most important in predicting the effect of soil erosion on crop production; is it erosion or sediment yield from an area? When MUSLE is used, deposition at some point on the area is assumed. Although this is expected on watersheds, deposition occurs both in cropped and noncropped areas. The area of cropland where deposition occurs is quite small relative to total cropland area, and is usually on lower slopes having little erosion. Yields on these areas may be affected only slightly by erosion or deposition. The debate has not involved any questions about the quality of soil loss estimates.

MODIFICATION OF THE USLE COVER AND MANAGEMENT FACTOR (C)

The USLE cover and management factor (C) is the ratio of soil loss from land cropped under specified conditions to the corresponding loss from clean-tilled fallow (Wischmeier and Smith 1978). It expresses the effect of variables related to cover and management on soil erosion. C-values are commonly expressed on an average annual basis for a specific site, crop system, and management. They also may be expressed as an average over a cropping period, even though variables affecting soil erosion might range considerably within that period. The methodology proposed here allows C to be computed daily from values of variables that are computed by the programs in EPIC and are known to affect soil erosion. A subfactor approach (Wischmeier 1975, Mutchler et al. 1982) is used to relate C to variables important in the erosion process. This equation is

$$C = (PLU)(CC)(SR)(RC) \quad [5.3]$$

where PLU is a prior land use subfactor, CC is a crop-canopy subfactor, SR is a subsurface-roughness subfactor, and RC is a residue-cover subfactor.

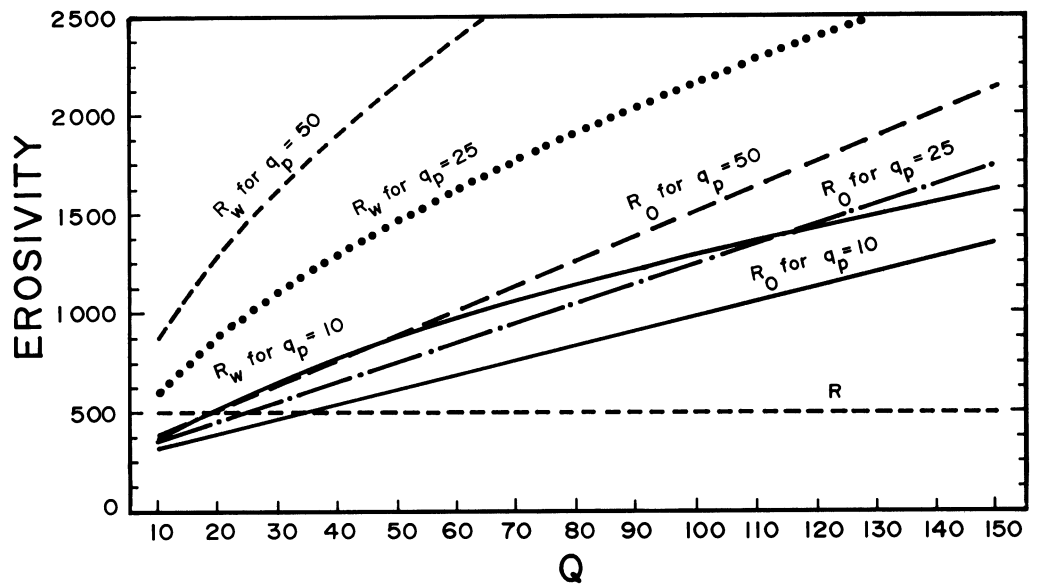

Figure 5.1
 Comparison of USLE rainfall erosivity factor value of 500 with the Williams (R_w) and Onstad-Foster (R_o) replacements.

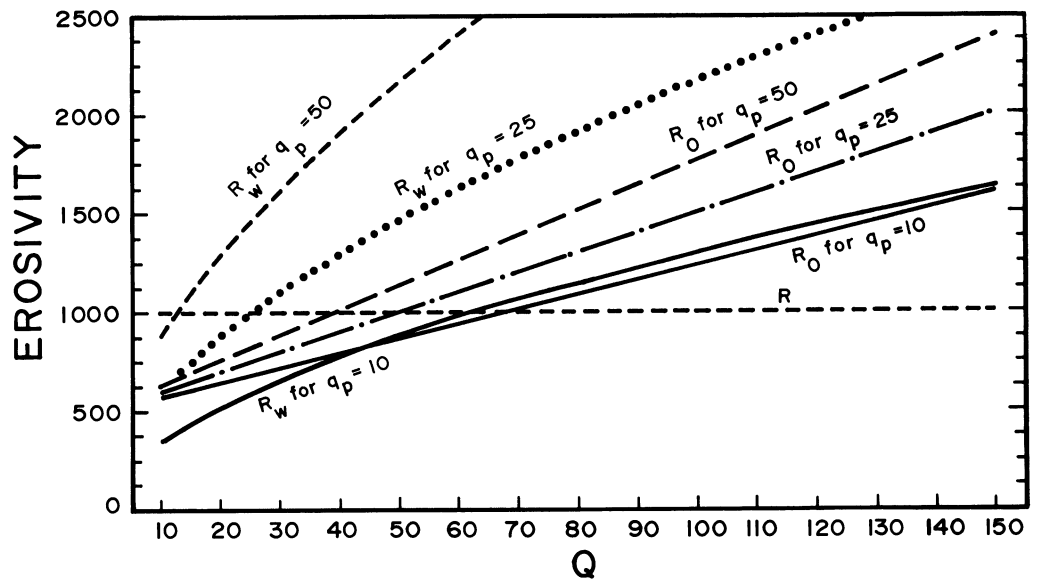

Figure 5.2
 Comparison of USLE rainfall erosivity factor value of 1000 with the Williams (R_w) and Onstad-Foster (R_o) replacements.

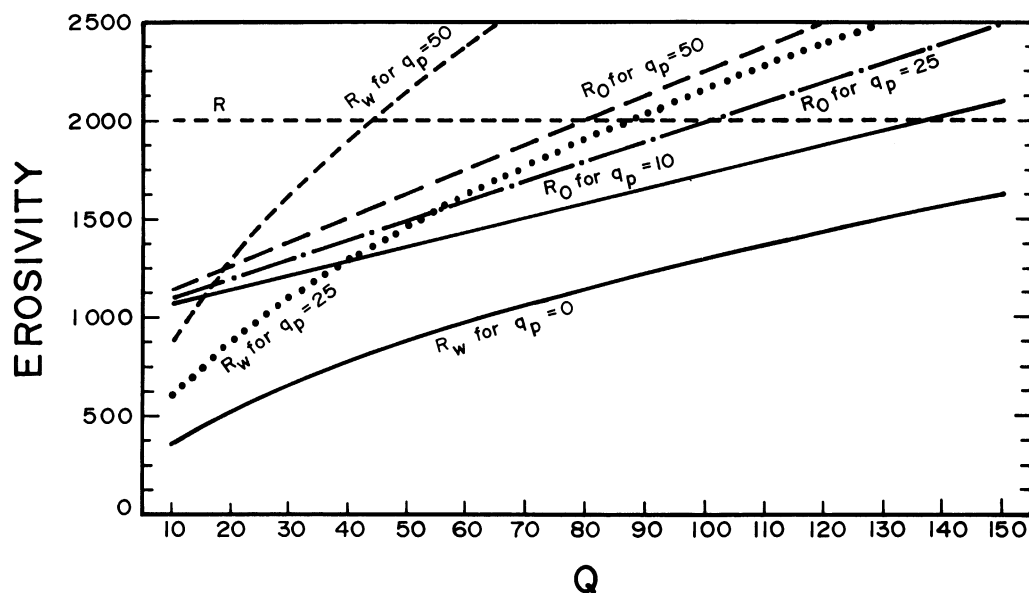

Figure 5.3
Comparison of USLE rainfall erosivity factor value of 2000 with the Williams (R_w) and Onstad-Foster (R_o) replacements.

PLU, Prior-Land-Use Subfactor

The effect of prior land use on soil erosion is well recognized. Wischmeier and Smith (1978) expressed this in a "sod factor." Also, incorporated residue is generally recognized as influencing soil erosion. Laflen and Moldenhauer (1979) quantified the effect of soybeans on soil erosion during the subsequent cropping period. The effect of prior land use then can be written as

$$PLU = CON[FA + FB(DBO)]\exp(-0.012 RSDU) \quad [5.4]$$

where CON is a consolidation factor, FA and FB are coefficients, DBO is the number of days since plowing of a sod or harvest of an oilseed crop, and RSDU is the average residue (kg/ha/mm depth) for the 10- to 100-mm depth. Values of FA and FB for cropped conditions are given in table 5.1.

Consolidation over time, such as would occur in no-till or meadow, reduces the erodibility of soil. This is expressed by the variable CON in equation 5.4. When tillage is performed, the effect of consolidation is negated. The consideration that occurs over a few months after tillage, has seemingly little effect on the erodibility of the soil. Hence, one value for CON (0.65) is used for no-till and meadow (and for no-till into meadow); another, for long-term undisturbed land such as pasture or range (0.45); and another, for all other conditions (1.0).

Table 5.1
Values of FA and FB for various cropping sequences

Period when values apply	Contained in cropping sequence		FA	FB
	Oilseed crop	Meadow		
All except for period after oilseed harvest or for period after plowing meadow ¹	Yes/No	Yes/No	1.00	0.0
First 2 years after plowing meadow, or first year after plowing meadow if oilseed grown first year after plowing meadow	Yes/No	Yes/No	.30	.00096
After oilseed harvest when oilseed grown first year after plowing meadow	Yes	Yes	.91	.00025
After oilseed harvest unless oilseed is grown first year after plowing meadow	Yes	Yes/No	1.40	-.0011

¹ Period after oilseed harvest is from harvest of oilseed to harvest of following crop or 1 year, whichever comes first. Period after plowing meadow is 2 years.

CC, Crop-Canopy
Subfactor

The relation between crop canopy and the crop canopy subfactor is expressed as

$$CC = 1 - FC[\exp(-0.34H)] \quad [5.5]$$

where H is the effective canopy height and FC is the fraction of land surface covered by crop canopy. This expresses the graphical relationship given by Wischmeier and Smith (1978) for the zero crop residue level. The relationship, which shows how the combined effects of canopy and residue affect C, was developed with the assumption that the fraction of rainfall intercepted by canopy is equal to the fraction of the land surface covered by canopy and that the intercepted rainfall reaches the ground as 2.5-mm diameter drops falling from some average height H. Quinn and Laflen (1981) showed that this relationship is satisfactory for corn.

Wischmeier and Smith (1978) indicated that the effects of canopy and residue are not fully additive; that is, the effects are not totally independent. Wischmeier (1975) discussed this

interaction in some detail. His reasoning dealt with the overlapping effects of canopy and residue on raindrop-impact energy. While both canopy and residue reduce erosion by reducing the impact energy of rainfall, residue also reduces erosion by reducing rill erosion, by establishing sites of deposition of eroded soil, and by reducing the transport capacity of runoff water. A study by Laflen and Colvin (1981) showed that residue was equally effective in reducing the erosion of soil under a wide range of canopy types. For these reasons, we did not include a crop-canopy and residue-cover interaction effect, but instead, elected to consider residue cover as a separate subfactor.

Values of H in equation 5.5 were estimated as 0.6 times the total height of the crop. Fraction of canopy cover (FC) can be computed

$$FC = 6.5LAI^{0.75} S^{-0.48} \quad [5.6]$$

where LAI is leaf-area index and S is row spacing (mm). Equation 5.6 is an unpublished relationship developed by Onstad.

SR, Surface-Roughness Sub-factor

Surface roughness is known to influence soil erosion. Cogo et al. (1983) showed that random roughness, an index of surface roughness (Allmaras et al. 1966), can be used to predict the effect of surface roughness on soil erosion. They also showed that surface roughness was reduced during a rainfall event. These results, as well as other unpublished works, were used to develop an equation expressing the effect of surface roughness, cumulative erosion, and incorporated residue on soil erosion. The effects of these variables on soil erosion are given by

$$SR = \exp[-0.026(RG-6)]. \quad [5.7]$$

where RG is a roughness factor expressed by the equation

$$RG = 6+(RB-6)(1-\exp[-0.00035 RS])\exp(-0.18EC) \quad [5.8]$$

In equation 5.8, RB is random roughness (mm), RS is residue amount (kg/ha) in the tilled zone (includes roots), and EC is cumulative erosion since last tillage. When the expression for RG is substituted into equation 5.7, equation 5.9 results:

$$SR = \exp[-0.026(RB-6)(1-\exp[-0.00035RS])\exp(-0.18EC)] \quad [5.9]$$

Values of RB for several tillage tools are given in table 5.2 and were estimated from data of Voorhees et al. (1981) and from unpublished measurements by Onstad and others.

The impact of tillage-induced roughness decreases as rainfall and/or soil erosion occurs. Erosive rains not only cause interrill erosion but also effectively reduce roughness. If soil loss occurs, rill patterns will be established, increasing erosion during successive rains. The use of a kinetic-energy term instead of an erosion term in equation 5.9 was considered.

SR approaches a maximum of 1 when the surface is smooth and is at a minimum when the surface is very rough, considerable residue is incorporated, and no erosion has occurred since tillage. Minimum values for SR are given in table 5.2 for several tillage tools.

Table 5.2
Values of variables associated with soil surface roughness due to tillage tool

Tool	RB(mm)	Mixing efficiency	Minimum values of SR	Minimum values of $(6/RG)^{0.08}$
Large offset disk	50	0.75	0.32	0.84
Moldboard plow	30	0.90	0.54	0.88
Lister	25	0.80	0.61	0.89
Chisel plow	20	0.33	0.69	0.91
Disk	18	0.50	0.73	0.92
Field cultivator	15	0.30	0.79	0.93
Row cultivator	15	0.50	0.79	0.93
Anhydrous applicator	13	0.15	0.83	0.94
Rod weeder	10	0.05	0.90	0.96
Planter	10	0.15	0.90	0.96
Smooth	6	--	1.00	1.00

From Voorhees et al. (1981) and unpublished data of C. A. Onstad and others.

RC, Residue-Cover Subfactor

The residue cover subfactor is expressed as

$$RC = \exp[-3.5 M (6/RG)^{0.08}] \quad [5.10]$$

where M is the fraction of the land surface covered by crop residue. The roughness factor RG is included as an interaction term with residue cover because roughness is expected to reduce the apparent effectiveness of residue in reducing runoff

velocity and sediment transport (Cogo et al. 1983). When a surface is smooth and considerable erosion has occurred, the value of $(6/RG)^{0.08}$ in equation 5.10 is nearly 1. Minimum values of $(6/RG)^{0.08}$ for various tools are given in table 5.2.

The coefficient -3.5. in equation 5.10 was another subject of considerable debate. Laflen et al. (1980) reviewed considerable published data and computed values of the exponent ranging from -1.6 to -7.4. G. R. Foster in an unpublished review also showed that there was a wide range of exponents. He evaluated data on stones and woodchips, as well as residue from small grains and row crops. Wischmeier and Smith's (1978) mulch factor closely follows an exponential relationship with a coefficient of -2.5. Laflen et al. (1978) noted that the effect of residue cover varied by slope; and Brenneman and Laflen (1982), by soil erosion. The value of -3.5 in equation 5.10 represents a consensus judgement, recognizing that the exponent ranges quite widely depending on conditions.

Because soil erosion is sensitive to residue cover, the relationship between residue cover and residue mass is important. Based on the mixing efficiency of a particular tillage tool (table 5.2) and the residue mass on the surface before tillage, the mass of residue that is mixed in the tillage zone, the mass remaining on the land surface, and the fraction of land surface covered by the crop residue after passage of the tillage tool can be computed. The mass of residue incorporated into the soil is the mass of above-ground plant material multiplied by the mixing efficiency of the tool, the mass remaining on the soil surface is obtained by difference, and the fraction of the land surface cover is computed with the following equation (Gregory 1982):

$$M = 1 - \exp(-aRW) \quad [5.11]$$

where M the fraction of land surface covered by crop residue, a is the ratio of the area covered by a single piece of residue to the mass of that piece of residue, and RW is the mass of surface residue per unit area of land surface (units are the inverse of those of a). When much of the residue is leaves, a large fraction of the ground surface is covered by a relatively small mass of residue, resulting in a large value of a . When leaves have disintegrated because of tillage and/or decomposition and mostly stalks, stems, cobs, etc., remain, the same mass of residue covers a much smaller area, resulting in a smaller value of a . The data base for making judgements about a -values is quite small and is summarized in table 5.3. Values recommended for use in equation 5.11 are given in table 5.4.

Table 5.3

Estimates of a-value, the ratio of area covered by a single piece of residue to the weight of the residue

Source	Type of residue	a-Value (ha/kg)	Time residue collected
Sloneker & Moldenhauer (1977)	Oats	0.0014	After harvest
Wischmeier & Smith (1978)	Straw	0.00054	-----
Gregory (1982)	Wheat	0.00048	After harvest
Sloneker & Moldenhauer (1977)	Corn	0.0004	After harvest
Gregory (1982)	Corn	0.00032	After harvest
Laflen ¹	Corn	0.00025	After planting
Sloneker & Moldenhauer (1977)	Soybeans	0.00072	After harvest
Gregory (1982)	Soybeans	0.00030	After harvest
Laflen ¹	Soybeans	0.00023	After planting
Gregory (1982)	Sunflowers	0.00020	After harvest
Laflen ¹	Sunflowers	0.00028	After harvest
Gregory (1982)	Cotton	0.00014	After harvest standing stems cut off

¹ Data unpublished.

Table 5.4

Recommended a-values for use in equation 5.11

Time	Type of residue	a-Value (ha/kg)
Harvest to first tillage	Corn, sorghum, soybeans, peanuts	0.0003
	Small grains	0.0005
	Cotton	0.00014
	Sunflowers	0.00020
	Alfalfa, pasture	0.00040
First tillage to harvest	Corn, sorghum, soybeans, peanuts	0.00020
	Small grains	0.00050
	Cotton	0.00014
	Sunflowers	0.00020
	Alfalfa, pasture	0.00020

Table 5.5

C-values obtained with equation 3 and with the USLE

Conditions	Date	C-Values	
		Computed	USLE
Meadow fall plowed, corn planted	May 15	0.25	0.26
Meadow fall plowed, corn planted	July 15	0.10	0.10
Continuous corn--moldboard plowed & disked	May 15	0.52	0.65
Continuous corn--moldboard plowed & disked	July 15	0.20	0.20
Continuous corn--fall chisel, spring disk	May 15	0.21	0.18
Continuous corn--fall chisel, spring disk	July 15	0.08	0.12
Continuous corn after fall chisel	Nov. 1	0.03	0.03
Oats--in spring-disked corn residue	April 15	0.12	0.22
Oats--in spring-disked corn residue	June 1	0.04	0.05
Corn--in corn/soybean rotation, no-till	May 15	0.17	0.25
Corn--in corn/soybean rotation, no-till	July 15	0.08	0.11
Soybeans--in corn/soybean rotation, no-till	May 15	0.03	0.05
Soybeans--in corn/soybean rotation, no-till	July 15	0.01	0.05
Meadow	July 15	0.01	0.004
Wheat--after fall-disked corn residue	Dec. 1	0.08	0.16
Wheat--after fall-disked corn residue	May 1	0.06	0.04

TESTING STORM SOIL LOSS SIMULATION

Because USLE, MUSLE, and OF are currently used in EPIC, their adequacy for predicting soil loss can be compared. Each of these soil loss equations was tested independently during its development and received an evaluation independent of the testing received here (Williams 1975, Onstad and Foster 1975).

The methodology we propose for computing C-values has yet to be incorporated into EPIC. At this time (Sept., 1989), this technology is being incorporated into a major revision of the Revised Universal Soil Loss Equation (RUSLE). The technology is similar to that proposed herein, with more extensive data sets that include more recent research findings. RUSLE also includes improvements in other relationships currently used in predicting soil erosion.

We made some comparisons of USLE C-values with those predicted using equation 5.3. These comparisons are given in table 5.5, and, for the most part, agree well. This agreement is not unexpected because in deriving our equations, we used some information from Wischmeier and Smith (1978). We also used some of the data sets common to the development of C-values for the USLE. This agreement is particularly true of the prior land-use subfactor as it relates to the period after plowing of a meadow and to soil erosion after soybeans.

Much of the information currently available concerning roughness and residue impacts on soil erosion was not available when Wischmeier and Smith (1978) prepared Agricultural Handbook 537. We used this information in the derivation of our equations; and while fine-tuned to only a certain extent, they do a good job of quantifying the impacts of a number of variables, heretofore only qualitatively evaluated, on C-values in the USLE.

NOTATIONS

A	= watershed area (ha)
C	= USLE cover and management factor
CC	= crop canopy subfactor
CON	= consolidation factor
DBO	= number of days since sod plowed
E	= storm rainfall energy (mj/ha)
EC	= cumulative erosion since last tillage (t/ha)
FA	= coefficient affecting prior-land-use subfactor
FB	= coefficient affecting prior-land-use subfactor
FC	= fraction of land surface covered by crop canopy (%)
H	= effective canopy height (m)
I	= maximum 30-min rainfall intensity (mm/hr)
LAI	= leaf area index (%)
M	= fraction of land surface covered by crop residue (%)
OF	= Onstad-Foster
PLU	= prior-land-use subfactor
Q _p	= peak flow rate (mm/h)
Q	= runoff volume (mm)
R	= USLE rainfall and runoff factor, also referred to as rainfall erosivity factor (mj.mm/ha.hr)
R _o	= rainfall erosivity factor of Onstad-Foster
R _w	= rainfall erosivity factor of Williams
RB	= random roughness (mm)
RC	= residue-cover subfactor
RG	= roughness factor
RS	= amount of residue (kg/ha)
RSDU	= average residue (kg/ha/mm/depth)
RW	= residue height (kg/ha)
S	= row spacing (mm)
SR	= subsurface-roughness subfactor

REFERENCES

- Allmaras, R.R., R.E. Burwell, W.E. Larson, R.F. Holt, and W.W. Nelson. 1966. Total porosity and random roughness of the interrow zones influenced by tillage. U.S. Dep. Agric. Conserv. Rep. No. 7.
- Brenneman, L.G., and J.M. Laflen. 1982. Modeling sediment deposition behind corn residue. Trans. Am. Soc. Agri. Eng. 25:1245-1250.
- Cogo, N.P., W.C. Moldenhauer, and G.R. Foster. 1983. Soil loss reduction from conservation tillage practices. Soil Sci. Soc. Am. J. 47:1005-1008.
- Foster, G.R., L.D. Meyer, and C.A. Onstad. 1977. A runoff erosivity factor and variable slope length exponents for soil loss estimates. Trans. Am. Soc. Agric. Eng. 20:683-687.
- Foster, G.R., D.K. McCool, K.G. Renard, and W. C. Moldenhauer. 1981. Conversion of the Universal Soil Loss Equation to SI metric units. J. Soil Water Conserv. 36:355-359.
- Gregory, J.M. 1982. Soil cover prediction with various amounts and types of crop residue. Trans. Am. Soc. Agric. Eng. 25:1333-1337.
- Laflen, J.M., J.L. Baker, R.O., Hartwig, W.F. Buchele, and H.P. Johnson. 1978. Soil and water loss from conservation tillage systems. Trans Am. Soc. Agri. Eng. 21:881-885.
- Laflen, J.M., and T.S. Colvin. 1981. Effect of crop residue on soil loss from continuous row cropping. Trans. Am. Soc. Agric. Eng. 24:605-609.
- Laflen, J.M., and W.C. Moldenhauer. 1979. Soil and water losses from corn-soybean rotations. Soil Sci. Soc. Am. J. 43:1213-1215.
- Laflen, J.M., and W.C. Moldenhauer, and T.S. Colvin. 1980. Conservation tillage and soil erosion on continuously row-cropped land. Proc. of Crop Production with Conservation in the '80s. Am. Soc. Agric. Eng., St. Joseph, MI.

- Mutchler, C.K., C.E. Murphree, and K.C. McGregor. 1982. Subfactor method for computing C factors for continuous cotton. Trans. Am Soc. Agric. Eng. 25:327-332.
- Onstad, C.A., and G.R. Foster. 1975. Erosion modeling on a watershed. Trans. Am. Soc. Agric. Eng. 18:288-292.
- Quinn, N.W., and J.M. Laflen. 1981. Characteristics of raindrop throughfall under corn canopy. Trans. Am. Soc. Agric. Eng. 26:1445-1450.
- Slonekar, L.L., and W.C. Moldenhauer. 1977. Measuring the amounts of crop residue after tillage. J. Soil Water Conserv. 32:231-236.
- Voorhees, W.B., R.R. Allmaras, and C.E. Johnson. 1981. Alleviating temperature stress, pp. 217-266. In Arkin, G. F. and H. M. Taylor (ed), Modifying the Root Environment to Reduce Crop Stress. Am. Soc. Agric. Eng., St. Joseph, MI.
- Williams, J.R. 1975. Sediment yield predictions with Universal equation using runoff energy factor, pp 244-252. In Present and Prospective Technology for Predicting Sediment Yields and Sources. U.S. Dep. Agric., Agric. Res. Serv. (Publ.) ARS-S-40.
- Williams, J.R. 1983. The physical components of the EPIC model. Proceedings of the International Conference on Soil Erosion and Conservation. Honolulu, HA.
- Wischmeier, W.H. 1975. Estimating the soil loss equation cover and management factors for undisturbed lands, pp. 118-125. In Present and Prospective Technology for Predicting Sediment Yields and Sources. ARS-5-40. Agric. Res. Ser., U. S. Dep. Agric., Washington, D.C.
- Wischmeier, W.H., and D.D. Smith 1978. Predicting rainfall erosion losses. U.S. Dep. Agric., Agric. Handb. 537.
- Young, R.A., and J.L. Wiersma. 1973. The role of rainfall impact in soil detachment and transport. Water Resour. Res. 9:1629-1636.

6. THE WIND EROSION COMPONENT OF EPIC

George W. Cole and Leon Lyles

ABSTRACT

The basic concept of soil flux integration is reviewed to show how it has guided the adaptation of the Wind Erosion Equation for use in the EPIC model. The major integration problems involved summing short-term, continual soil losses to give 1 day's soil loss. The adaptation is reviewed and the results of some numerical data are compared.

INTRODUCTION

The Wind Erosion Equation, which was developed to predict annual average soil loss associated with a single crop (Skidmore 1976, Skidmore and Woodruff 1968, Woodruff and Siddoway 1965), was adopted for use in EPIC. The adaptation was needed because in simulating the long-term effects of soil loss due to wind- and water-induced erosion, EPIC computes at a daily rate and considers multiple crops per year. The Wind Erosion Equation (WEE), therefore, had to be adapted so that (1) soil loss would be expressed in metric tonnes per (hectare.day) rather than tons per (acre.year), (2) it would simultaneously handle a growing crop and residues from previous crops, and, most importantly, (3) it would compute soil losses for 1-day rather than 1-year intervals.

In the following sections, the basic structure of the WEE is reviewed as an aid to comprehending the modifications used in adapting the equation for use in EPIC. For a more comprehensive review see Cole et al. (1982). The modifications are then discussed and, finally, some numerical results from typical EPIC simulations are analyzed.

WIND EROSION

General Concepts

WEE was developed originally as a prediction and design tool to estimate soil loss and the effects of various conservation practices in reducing soil loss. Consequently, the units of measurement were chosen to be grasped easily. For example, since soil loss is cyclic with a yearly period, the unit of a year was a natural choice.

The variable chosen to express soil loss, E , has the units of soil loss flux. However, since it is defined as a potential average annual soil loss (Woodruff and Siddoway 1965), E represents the temporal and spatial average of f , the "point" flux. E cannot vary in the interval of 1 year or over the space of a given field. It can only vary according to five factors: I , K , C , L , and V (all symbols are defined in the "Notations"

section of this chapter). Actually, these factors are functions of other variables. Because E is an average flux in space and time, we have the following for an erodible rectangular field of area A and duration T :

$$m = \int_T \int_A f(x,y,t) dx dy dt \quad [6.1a]$$

and

$$E = m/(AT) \quad [6.1b]$$

The geometry for any such rectangular field of area A ($A = lw$) is depicted in figure 6.1. For any other geometry, a different functional relationship would exist for E . The implication is that a different wind erosion equation would be required for each shape; e.g., WEE is not adequate for a circular field. However, since A and T are contained in the limits of integration of equation 6.1a and the divisor of equation 6.1b, the same f would apply for any shape or duration.

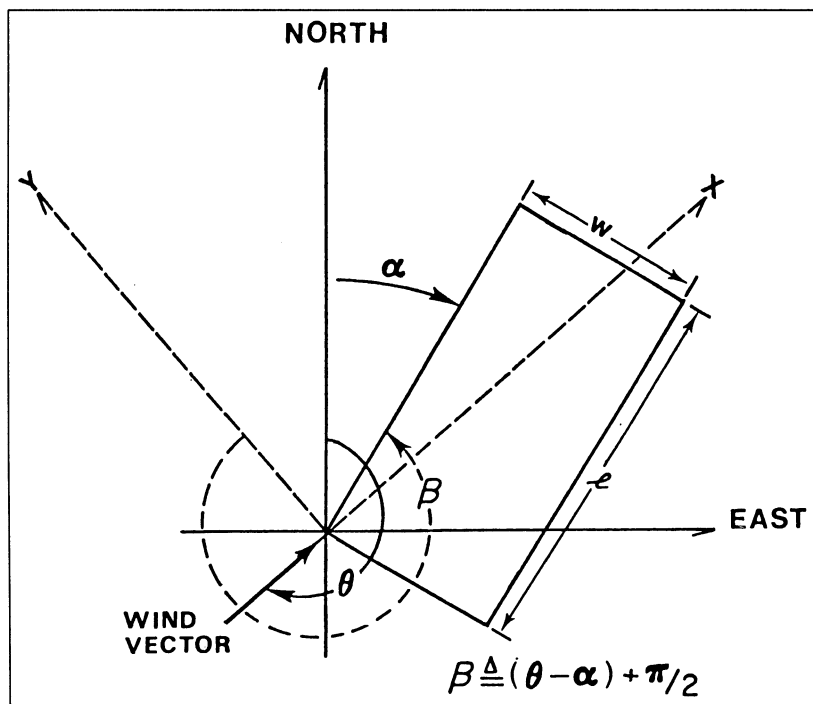

Figure 6.1
A plan view of a rectangular field, relative to north, showing the defining angles and the wind reference coordinate system.

Woodruff and Siddoway (1965) and Skidmore and Woodruff (1968) imply that

$$E = f_2[V, f_3(IK, IKC, L)] \quad [6.2]$$

Since equations 6.1b and equation 6.2 are equivalent, there must exist a relationship similar to equation 6.1a such that

$$m = \int_T \int_A f_4(\hat{V}, \hat{I}, \hat{K}, \hat{C}, x) dx dy dt \quad [6.3]$$

where all or some of the independent variables are functions of space and/or time. The use of the caret on the factor implies that if an independent variable is present in equation 6.2, then some unknown functional form must exist at the flux level, i.e., f_4 , for each factor.

Modifications

The major problem in adapting the wind erosion equation for use in EPIC is the unavailability of f_4 . In its place we must use its integrated form, i.e., equation 6.2. In this section we describe the method to accomplish this, along with the method of accounting for the time and space variations of the factors that affect soil loss.

EPIC provides the framework to sum the effects of the various factors that affect soil loss and, hence, productivity. From the point of view of soil loss by wind, loss is equivalent to the sum of the daily soil loss surface density. This sum is expressed analytically by rearranging equation 6.1 into

$$E = \frac{1}{AT} \int_T \int_y q dy dt \quad [6.4]$$

where

$$q \triangleq \int f dx \quad [6.5]$$

Rearranging Eq. [6.4] results in

$$E_{EPIC} = \frac{1}{T} \sum_{i=1}^n \left[\frac{1}{A} \int \Delta t_i q dt dy \right] \quad [6.6]$$

where the bracketed quantity represents the daily soil loss per unit area (m_i), and T the simulation period.

The modifications of WEE must produce the equivalent of the daily soil loss surface density shown in brackets in equation 6.6. EPIC sums for n days, where n is chosen prior to simulation. In equation 6.6 the order of integration of t and y

is the reverse of that in equation 6.4. This reversal implies that the q as computed does not change during the day; i.e., it is a daily average. This assumption then restricts the y integration for a fixed wind angle (θ), which results in a simple computation of L , since there is only one integration over the field in the y direction for 1 day.

The problem of inputs changing during the period of computation has been simplified but not changed. Variables such as I , K , and V can now be considered essentially constant for a single day; but L will change, since θ and u change on a shorter time scale than EPIC's computation iteration period of 1 day. Hence, we are faced with converting q to some daily average value. This is similar to the problem Chepil faced; i.e., how to convert from short-time, essentially continuous relative soil loss with fixed input variables to absolute soil loss for a year (Chepil 1960). Here we have to convert from short-term soil losses to 1 day's rather than 1 year's soil loss, but the problem remains, since the description of the wind variable that drives soil loss still fluctuates considerably during 1 day.

The justification for using a daily average is based on an argument used in calculus, i.e., that a sum based on finite increments becomes exactly equal to the integral as the increment approaches zero. Here then, we claim that long-term calculations of soil loss based on daily averages will approach that based on the original experimental short-term data more closely than a single calculation for 1 year.

The above argument presupposes that q is available! This is hardly so, as noted by Cole et al. (1982). What is needed, then, is a relationship which when applied to E would approximate the integration of q for 1 day, yielding "daily E ".

The best available function that approximates this desired function involves a single multiplication factor that Bondy et al. (1980) called the erosive wind energy factor. They used a monthly factor to subdivide E , while allowing the I , K , L , and V factors to take on values for the periods under consideration. We extended their concept by shortening the period of interest from month to a single day.

The assumption that soil loss is directly proportional to erosive wind energy is implied by equation 6.7 which computes period average soil loss flux, i.e.,

$$E_i = r_i E \quad [6.7]$$

where r_i is the erosive wind energy factor for the i th period. If E has units of tonnes per (hectare.year), then E_i has units of tonnes per (hectare.day).

To utilize equation 6.7 with equation 6.6 requires that m_i be determined, i.e.,

$$m_i'' = \Delta t_i E_i$$

However, since Δt_i in EPIC is 1 day, both variables are numerically equal; and, consequently, E_i can be summed as if it were m_i'' .

The erosive wind energy factor is calculated as

$$r_i = e_i / \sum_{i=1}^n e_i \quad [6.8]$$

where

$$e_i \triangleq \int_{\Delta t_i} \dot{W} dt \quad [6.9]$$

or equivalently,

$$e_i = c_i \langle u_e^3 \rangle_i \Delta t_i \quad [6.10]$$

equation 6.10 is derived from equation 6.9 by expressing the work rate \dot{W} , in terms of the steady state form of the first law of thermodynamics, i.e.,

$$\dot{W} = \begin{cases} \dot{P} - \dot{Q} & u > u_t \\ 0 & u \leq u_t \end{cases} \quad [6.11]$$

where

$$P = \int_{A_3} \tau_{zx}(z) u(z) dx dy \quad [6.12]$$

and \dot{Q} is zero for all $u > u_t$. Equation 6.12 expresses the total power flow into a rectangular control volume that represents the boundaries of a one-dimensional fluid-flow soil-loss system.

For application in EPIC, equations 6.7, 6.8, and 6.10 are used, with the index i representing the i th day and the upper limit n in equation 6.8 representing the number of days in a year. The daily value of $\langle u_e^3 \rangle$ is computed by using a regression equation relating it to $\langle u \rangle$. This regression equation was developed from the following two equations, assuming that the daily windspeed is distributed as a two parameter Weibull distribution, p , i.e.,

$$\langle u_e^3 \rangle = \int_{u_t}^{\infty} u^3 p(u, k, c) du; \quad k \triangleq 2 \quad [6.13]$$

and

$$c \triangleq 1.12 \langle u \rangle \quad [6.14]$$

Equation 6.13 is derived from the standard definition of the third moment of the distribution, p . For erosive wind, the integration is for all values greater than the threshold value, u_t . Figure 6.2 illustrates how these modifications (and those that follow) fit into the EPIC's wind erosion submodel.

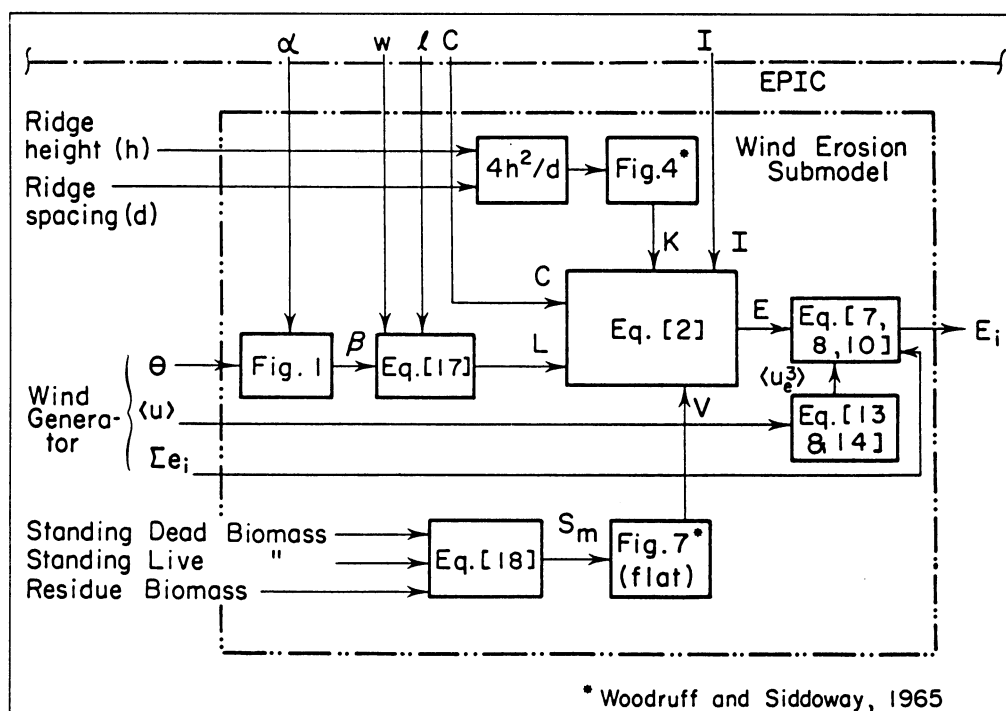

Figure 6.2
Block diagram of the wind erosion submodel and its interfaces within EPIC.

Having now dealt with the time integration of q in equation 6.6, the integration with respect to y must be considered. If, as in the previous argument, we claim that the application of the erosive wind energy factor approximates the removal of the integration from E , we might also attribute to it the capability of removing the crosswind or y component of integration. An alternate hypothesis involves the use of a single worst L , by Chepil et al. (1964), i.e.,

$$L = w \sec A; \quad 0^\circ < A < 85^\circ \quad [6.15]$$

where A is defined as the angle between side w of the field and the positive x axis and is called the prevailing wind erosion direction. Because they used this L , the value of E would imply a rectangular field of width w and length L that is aligned on the L side with the average wind vector. Here again, L is independent of y . In other words, the effect of varying L into E was desired and was accomplished external to WEE.

To properly incorporate the effect of varying L with y would require integration of equation 6.7 over y for each day or equivalently for each field angle β . This integration would be equivalent to perhaps 10-20 computer solutions of equation 6.7 per time step, depending on the size of Δy .

By adopting a scheme to select "an L " that yields the "correct answer," one can reduce the number of computations. This is, in essence, what Chepil et al. (1964) implied by his worst case estimate and also what Skidmore (1965) implied by his time weighting concept. Because neither approach appears to be founded upon actual integration of q with respect to y , it appears that any reasonable scheme that satisfies

$$0 < L < (\ell^2 + w^2)^{1/2} \quad [6.16]$$

would be an adequate approximation. We selected an average of the chords as they vary in y , which for a rectangular field of 1 and w oriented at β is

$$L = \frac{\ell w}{w |\cos \beta| + \ell |\sin \beta|} \quad [6.17]$$

While equation 6.17 is arbitrary, it does satisfy the criteria of equation 6.16 and is simple to compute.

Finally, we come to the method used in EPIC to simultaneously simulate the effects of a growing crop and residue from a previous crop. Due to the paucity of mixture data, a modification of the method of Lyles and Allison (1980) was proposed. That is,

$$S_m = \sum_{i=1}^n P_i S_{it} \quad [6.18]$$

where

$$P_i = R_i / \sum_{i=1}^n R_i \quad [6.19]$$

$$\sum_{i=1}^n P_i = 1 \quad [6.20]$$

and S_{it} is the grain equivalent for crop i (Lyles and Allison 1980), based on the total mixture weight. S_m (equation 6.18) is a weighted sum that satisfies the following two criteria:

$$(S_{it})_{\min} \leq S_m \leq (S_{it})_{\max} \quad [6.21]$$

and

$$S_m \rightarrow S_k; \quad i = 1, 2, \dots, k, \dots, n \quad [6.22]$$

as

$$P_k \rightarrow 1. \quad [6.23]$$

However, based on the further simplifying assumption that S_i is linear, the actual implementation in EPIC is a simple sum of S_i .

SIMULATION RESULTS

No measured data sets of erosion amounts are available for validating EPIC modifications of WEE. Using representative soils, crop rotations, and management operations for various States in the Midwest, Great Plains, and West, we compared 50 years' estimates of erosion amounts as simulated by EPIC and WEE according to current procedures (Bondy et al. 1980). We chose 10 counties to give geographic coverage and various crop rotations common to those counties (table 6.1).

Table 6.1

Wind erosion estimated by EPIC and WEE for selected crop rotations and locations in the United States

Comparison run No.	Crop rotation sequence ¹	Location		Av. estimated soil loss		
		County, State	Soil ²	t/(ha.yr) ⁴		WEE
				EPIC ³		
1.	Corn-soy	Auglaize, OH	Keene SiL	0.1 ±0.1	0.1	
2.	Corn-soy	Auglaize, OH	Keene SiL	0.8 ±0.4	1.3	
3.	Corn	Harrison, IA	Ida SiL	⁵ 0.3 ±0.3	2.8	
4.	Corn	Harrison, IA	Ida SiL	⁵ 2.4 ±.7	2.6	
5.	Corn-soy	Monona, IA	Luton SiC	⁵ 1.1 ±0.5	3.4	
6.	Corn-soy	Monona, IA	Luton SiC	9.2 ±4.6	11.5	
7.	Whet-whet-falo	McLean, ND	Williams L	⁵ 0.0 ±0.0	0.4	
8.	Whet-whet-falo	McLean, ND	Williams L	⁵ 2.6 ±2.4	9.8	
9.	Whet-falo	Bennett, SD	Keith SiL	⁵ 1.3 ±2.0	0.7	
10.	Whet-falo	Lyman, SD	Promise C	1.4 ±2.4	1.1	
11.	Whet-falo	Lyman, SD	Promise C	8.7 ±9.3	3.2	
12.	Whet-falo	Cheyenne, NB	Alliance SiL	0.2 ±1.2	0.0	
13.	Whet-corn-falo	Red Willow, NB	Keith SiL	3.5 ±2.4	1.9	
14.	Whet-corn-falo	Red Willow, NB	Keith SiL	4.7 ±3.0	1.9	
15.	Corn (irr)	Sherman, KS	Keith SiL	⁵ 9.2 ±1.8	4.3	
16.	Grsg (irr)	Finney, KS	Carwile FLS	101.1 ±10.3	24.2	
17.	Grsg-falo	Finney, KS	Carwile FLS	125.1 ±23.1	120.2	
18.	Whet-grsg-falo	Stevens, KS	Vona SL	28.2 ±20.1	18.1	
19.	Whet	Carson, TX	Pullman CL	⁵ 4.7 ±4.3	1.0	
20.	Whet-grsg-falo	Deaf Smith, TX	Pullman CL	31.8 ±26.9	34.6	
21.	Cotn-grsg	Bailey, TX	Amarillo FSL	119.1 ±25.4	130.6	
22.	Cotn	Bailey, TX	Amarillo FLS	165.8 ±26.9	199.4	
23.	Cotn	Gaines, TX	Patricia FS	741.6±117.7	581.2	
24.	Whet-falo	Prowers, CO	Baca Cl, Wiley SiL	3.9 ±2.7	0.2	
25.	Cotn-cotn-grsg	Quay, NM	Pullman L	54.4 ±14.7	47.3	
26.	Whet-alfa-alfa	Curry, NM	Amarillo FSL	41.7 ±19.0	5.6	
27.	Oats-oats-alfa alfa-alfa	Churchill, NV	Tipperary S	22.2 ±11.5	8.8	

¹ Soyb = soybeans, whet = wheat, falo = fallow, grsg = grain sorghum, irr = irrigated, cotn = cotton, alfa = alfalfa.

² SiL = silt loam, SiC = silt clay, L = loam, C = clay, FSL = fine sandy loam, SL = sandy loam, CL = clay loam, S = sand.

³ 50-year average.

⁴ + - 1 standard deviation.

⁵ 49-year average.

Agreement between EPIC and WEE was excellent for 17 comparison runs, fair for 7, and poor for 3. Possible reasons for differences between the two methods of estimating wind erosion include

1. EPIC has residue decomposition equations that are applied daily. In WEE, an average overwinter residue loss, usually 15 to 30 %, is applied at the end of winter in the rotation.
2. Simplified forms of the small-grain equivalent equation are used in EPIC, while the original equations are used in solving WEE.
3. Simulated wind data are used in EPIC. Actual long-term average data are used in WEE.
4. A daily L factor is applied in EPIC, whereas a weighted approach by period is used to determine L for application in WEE.

The large difference between the estimates for run 16 is apparently due to EPIC's use of two shredding operations to simulate grazing by cattle (table 6.1). The crop residue reductions appear larger than would be expected from cattle grazing the grain sorghum leaves after harvest. Runs 26 and 27 indicate some problem in EPIC's simulation of dry matter production during establishment and early growth of perennial crops--in these runs, alfalfa.

For 8 runs, 49-year averages of estimates by EPIC are reported because the first-year erosion estimates were incompatible with the other 49 estimates (table 6.1). These first-year anomalies may have been due to the fact that crop residue conditions prior to the starting date of the simulations were ignored.

These comparisons between EPIC and WEE are a check on procedures for determining factor values between the two methods and not a validation of EPIC. Biomass production (excluding grain) has a major impact on wind erosion estimates. We used 50-year average biomass outputs of EPIC in solving WEE. Consequently, values in table 6.1 are not realistic, unless EPIC accurately predicts dry matter production.

NOTATIONS

Symbol	Definition and Dimensions ¹
A	= area of the erodible field, L^2 , or the angle between w and the positive x axis (dimensionless)
A_3	= top surface of a control volume for the soil loss system (L^2)
C	= climatic factor (dimensionless)
c	= parameter for function p (L/T)
c_1	= a constant
d	= ridge spacing (L)
E	= potential average annual soil loss ($M L^{-2}T^{-1}$)
e_i	= erosive wind energy for the i th period ($M L^2T^{-2}$)
f	= the normal component of the net soil flux vector along the ground surface ($M L^{-2}T^{-1}$)
f_i	= a function, i an an integer subscript used to differentiate between functions.
h	= ridge height (L)
I	= soil erodibility ($M^{-2}T^{-1}$)
K	= soil ridge roughness (dimensionless)
k	= k th value of an index or parameter for function p (dimensionless)
L	= field length, a function (L)
ℓ	= larger dimension of a rectangular field (L)
m	= soil loss (M)
m''	= soil loss per unit area (M/L^2)
n	= upper limit of an index (dimensions vary)
P	= Power into soil loss system ($M L^2T^{-3}$)
P_i	= proportion of R_i in mixture (dimensionless)
p	= a Weibull probability density function (T/L)
Q	= energy loss from soil loss system as heat ($M L^2T^{-2}$)
q	= integral of f along x within the limits of the field ($M L^{-1}T^{-1}$)
R	= biomass (surface) density, dry weight of vegetative cover per unit area (M/L^2)
r_i	= erosive wind energy factor for the i th period (dimensionless)
S	= small grain equivalent, small grain biomass surface density (M/L^2)
T	= time interval, on the order of 1 year (T)
t	= time, T, or metric tonnes (M)
u	= wind velocity (L/T)
u_e	= erosive wind velocity (L/T)
u_t	= threshold velocity, the wind velocity below which no soil moves (L/T)

V = equivalent quantity of vegetative cover (M/L^2)
 W = work done in moving soil ($M L^2T^{-2}$)
 w = small dimension of a rectangular field (L)
 WEE = Wind Erosion Equation
 x = distance along the field in the wind direction (L)
 y = distance perpendicular to x and z (L)
 z = distance perpendicular to x and y (L)
 α = the field angle relative to north, clockwise
 positive (dimensionless)
 β = the field angle relative to the wind,
 counterclockwise positive from the positive y axis
 (see fig. 6.1) (dimensionless)
 Δ = difference operator (dimensionless)
 θ = the direction of the wind vector relative to north,
 clockwise positive (dimensionless)
 π = Pi, 180° (dimensionless)
 τ_{zx} = shear stress on z plane in x direction ($M L^{-1}T^{-2}$)

Subscripts

i = index
 k = k th value of an index
 m = mixture
 t = total

Superscripts and other symbols

n = upper limit of index (dimensions vary)
 $\hat{\quad}$ = caret variable is time and/or space dependent
 $\dot{\quad}$ = implies variable is a time rate of change
 $\langle \quad \rangle$ = enclosed function is an average with respect to an
 interval
 $\underline{\quad}$ = defined

¹M, L, T refer to the dimensions of mass, length and time.

REFERENCES

- Bondy, Earl, Leon Lyles, and W.A. Hayes. 1980. Computing soil erosion by periods using wind energy distribution.
- Chepil, W.S. 1960. Conversion of relative field erodibility to annual soil loss by wind. Soil Sci. Soc. Am. Proc. 24:143-145.
- Chepil, W.S., F.H. Siddoway, and D.V. Armburst. 1964. In the Great Plains prevailing wind erosion direction. J. Soil Water Conserv. 19:67-70.
- Cole, G.W., L. Lyles, and L.J. Hagen. 1982. A simulation model of daily wind erosion soil loss. Am. Soc. Agric. Eng. Paper No. 82-2575, ASAE, St. Joseph, MI 49085.
- Lyles, Leon, and B.E. Allison. 1980. Range grasses and their small grain equivalents for wind erosion control. J. Range Manage. 33:143-146.
- Skidmore, E.L. 1965. Assessing wind erosion forces: directions and relative magnitudes. Soil Sci. Soc. Am. Proc. 29:587-590.
- Skidmore, E.L. 1976. A wind erosion equation: development, application, and limitations. In ERDA Symposium Series 38, Atmosphere-Surface Exchange of Particulate and Gaseous Pollutants (1974), pp. 452-465.
- Skidmore, E.L., and N.P. Woodruff. 1968. Wind erosion forces in the United States and their use in predicting soil loss. U.S. Dep. Agric., Agric. Handb. No. 346, 42 pp.
- Woodruff, N.P., and F.H. Siddoway. 1965. A wind erosion equation. Soil Sci. Soc. Am. Proc. 29:602-608.

7. THE NUTRIENT COMPONENT OF EPIC

A.N. Sharpley, C.A. Jones, and J.R. Williams

ABSTRACT

This chapter outlines the nutrient component model of EPIC. At present, the only nutrients considered are nitrogen (N) and phosphorus (P). The routines used to simulate transformations within and between organic and inorganic forms are detailed. The incorporation of fertilizer N and P additions into soil pools is outlined along with plant uptake of N and P. Minimum sets of soil N and P data needed to run the submodel are listed and can be obtained from readily available soil chemical and taxonomic characteristics. In addition, critical soil P concentrations, which are considered to be sufficient for near-maximum crop production, are presented from a survey of soil test laboratories. These concentrations will allow the user to specify a critical P level for a given soil type and crop when a measured value is not available.

INTRODUCTION

Simulation models may improve the ability to analyze soil nutrient transformations and losses and thereby improve fertilizer recommendations and management (Tejeda et al. 1981; Penning de Vries 1980). At present EPIC considers only the plant nutrients nitrogen N and P in the soil and added as fertilizers. Several models have been developed to simulate specific soil processes such as ammonia volatilization (Parton et al. 1983) denitrification (Smith 1981), P flux (Claassen and Barber 1974), organic P transformation (Mishra et al. 1979), and P availability (Barrow and Carter 1978; Bennett and Ozanne 1972; Cox et al. 1981). More comprehensive models have been developed for N (Watts and Hanks 1978; Seligman and Van Keulen 1981) and P cycling (Cole et al. 1977; Harrison 1978). There is a need, however, for a simple model that can use readily available soil and plant data to simulate soil N and P cycling.

This chapter discusses the simulation of soil N and P cycling, provides information on minimum data sets needed, and provides critical available P values. The general N and P pools and flows considered are illustrated in figures 7.1 and 7.2, respectively.

NUTRIENT MODEL COMPARTMENTS

Organic Transformations

The N mineralization and immobilization models, which comprise the nutrient component model of EPIC, are based on the PAPRAN model (Seligman and Van Keulen, 1981) and are simplified versions of the nitrogen transformation model in CERES (Jones and Kiniry 1986) with a single mineral N pool. Soil organic

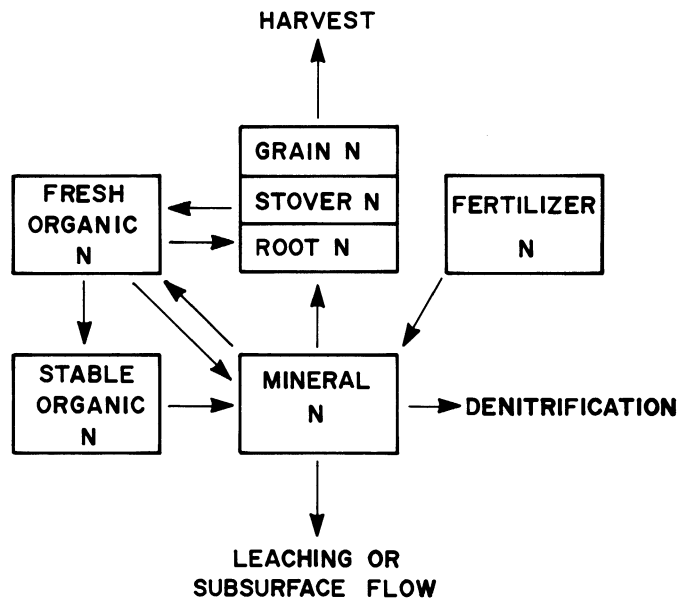

Figure 7.1
Nitrogen pools and flows in the nutrient submodel of EPIC.

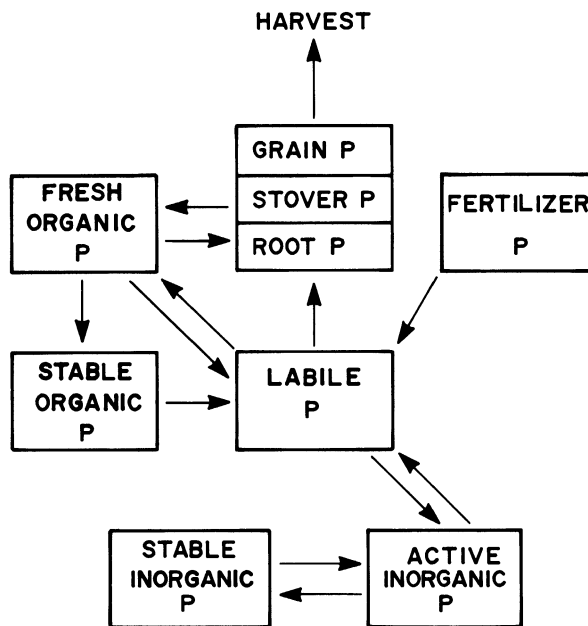

Figure 7.2
Phosphorus pools and flows in the nutrient submodel of EPIC.

matter and organic N in each soil layer are partitioned into fresh (labile protein and carbohydrate fraction) and stable (decay-resistant humus fraction) pools. Decay rates are a function of soil water, temperature, and mineral N availability and of time after residue incorporation. Net mineralization occurs if N released during decay of the fresh pool is greater than that required for decay. The potential rate of N mineralization is calculated by a first-order rate constant (0.0001 d^{-1}), which can be modified for suboptimal temperatures and amounts of soil water. However, net immobilization may occur if the fresh pool has a high C:N ratio, large amounts of N from other sources being required by the microbes involved in the immobilization. This process is regulated by temperature and the amounts of soil water, mineral N, and labile P.

Transformations of organic P in crop residues and soil organic matter are similar to transformations of organic N. Organic P is divided into a fresh residue pool, consisting of P in the microbial biomass and undecomposed residues, and the stable organic pool, consisting of P in stable organic matter. Stable organic matter P is divided into mineralizable and nonmineralizable pools, their relative sizes dependent on the duration the land has been under cultivation.

Organic P and N mineralizations are similar. When labile P is deficient, however, P mineralization increases as a reflection of the increased phosphatase enzyme activity of soil microbes, also, the P:C ratio of soil microbes decreases from 0.02 to 0.01.

Inorganic Transformations

Of the inorganic N transformations, only mineral N is simulated at present. Mineral N is assumed to be $\text{NO}_3\text{-N}$. Denitrification, which occurs only when soil moisture content is above the drained upper limit, is a first-order function of mineral N availability, which is affected by the relative degree of soil saturation, soil temperature, and amount of soluble C associated with soil organic matter (Rolsten et al. 1980).

Inorganic P is considered to be transferred among three pools: labile P (resin extractable), which is available for plant uptake; active inorganic P, which is in equilibrium with labile P but is not plant available; and stable inorganic P. The active and stable pools are operational definitions only, and no chemical forms are implied.

Labile P content is calculated from soil test P and chemical and taxonomic characteristics of the soil (Sharpley et al. 1984). Similarly, the equilibrium between labile and active P pools is soil specific and controlled by sorption capacity calculated from soil chemical and taxonomic characteristics. Slow P

sorption controls the gradual movement of labile and active P to the stable pools (Jones et al. 1984a). If labile P content is very low (2-5 mg/kg) movement from stable to active pools occurs very slowly, allowing only limited crop growth and long-term maintenance of very low levels of labile P.

Fertilizer Application

The date, rate, depth, and type of fertilizer N and P are specified by the user. Both fertilizer N and P are considered to dissolve immediately and contribute to mineral N and labile P pools. Only changes in the size of one mineral N pool, which mimics the $\text{NO}_3\text{-N}$ pool, is simulated; therefore, ammonium volatilization and fixation, and nitrification are not simulated.

When fertilizer P is added a fraction remains in the labile pool and the remainder is transferred to the active inorganic P pool. The distribution of fertilizer P between labile and active pools (fertilizer P availability index) is estimated from soil chemical and taxonomic characteristics (Sharpley et al. 1984). The fertilizer availability index ranges from less than 0.1 in soils which sorb large amounts of P to more than 0.7 in soils of low P sorption capacity. At present, P fertilizer dissolution rate is not considered; however, work is under way to include routines to account for differences in fertilizer solubilities.

Plant Uptake

Plant uptake of N and P are controlled either by plant demand or soil supply of the nutrients. Plant demand for N or P is the difference in the actual plant N or P concentration and the optimum N or P concentration of the same biomass. Plant demand is based on phenological age of the plant, the critical N or P concentration for that phenological stage (Jones 1983), and the actual N or P concentration of the plant.

Potential plant uptake of N from a soil layer is a function of the mineral N concentration of and water use from the layer. Actual plant uptake of N during a day is the minimum of plant demand and potential uptake from all soil layers. Once in the plant, N is partitioned among the vegetative shoot, root, and economic yield, defined as the portion of the plant removed from the field at harvest. Nitrogen deficiency factors are based on actual, critical, and minimum shoot N concentrations and are used to effect biomass accumulation and leaf area expansion. Part of the N contained in the vegetative parts can be translocated to the economic yield.

The plant takes up P from the labile pool and distributes it to root, shoot, and economic yield. Potential uptake of P is assumed to be a linear function of labile P, up to a user-specified critical concentration. This critical P concentration can vary widely among soils and crops and will be discussed in greater detail later in this chapter. Potential

plant uptake from a soil layer is also a function of soil moisture and the fraction of the total root system in that layer. The rate of P uptake from a soil layer is assumed to be 1.5 times that needed to maintain the optimum plant P concentration when P uptake is not limited by soil moisture, root distribution and labile P content.

DATA REQUIREMENTS

The minimum data set required for the N and P models are given in table 7.1. Initial mineral N is represented by $\text{NO}_3\text{-N}$, obtained from soil test information. For P, however, none of the required data are available from soil survey information and reports. Consequently, regression equations were developed to estimate labile P from soil test P, organic P from total N or organic C, and fertilizer availability index from soil chemical and taxonomic characteristics (Sharpley et al. 1984). Thus, except for mineral N and labile P, the minimum data set required to run the N and P models can be obtained from soil chemical and taxonomic data available in U.S. Soil Conservation Service/State Agricultural Experiment Station Soil Survey Investigative Reports and pedon descriptions.

As mentioned earlier, estimates of the critical P concentration considered to be sufficient for near maximum crop production vary among crops and soils as well as soil test laboratories. The reason is that most soil test laboratories use soil P test methods which work well for soils and crops in their areas of interest. According to Kamprath and Watson (1980), the following are the most commonly used methods--Olsen (0.05M NaHCO_3) (Olsen et al. 1954), Bray I ($0.025\text{M HCl} + 0.03\text{M NH}_4\text{F}$) (Bray and Kurtz 1945), and Mehlich I or North Carolina double acid ($0.05\text{MHCl} + 0.0125\text{M H}_2\text{SO}_4$) (Sabbe and Breland 1974). Less common methods include Bray II (Bray and Kurtz 1945), Mehlich III (North Carolina Department of Agriculture 1982), Mississippi (Soil Testing Laboratories of the Southern Region of the United States 1974), and Texas A&M (Texas Agricultural Extension Service 1983). In addition, many minor modifications have been made in the more common soil P test methods at different laboratories across the county. EPIC deals with this variation in the critical level of soil test P by allowing the user to specify the critical value for each crop.

Since not all users are familiar with critical levels of soil test P, we compiled a list of these values with the help of several Government and University soil test laboratories. These cooperators were asked to use the Cate-Nelson graphical method (Nelson and Anderson 1977) to provide the concentration of soil test P above which the probability of response to fertilizer P is small. In practice, this is approximately the "break point" in the curve relating relative crop yields to soil test P. Some

cooperators chose to provide estimates in terms of percent maximum yield from a Mitscherlich-type response curve. Some cooperators also provided P concentrations above which no yield response is found or above which no fertilizer P is recommended. Cooperators often provided different critical values for several crops or groups of crops and/or for different groups of soils.

The compilation and pertinent information are presented in tables 7.2-7.5. Except in Arkansas, the critical Bray I P concentrations for most crops are from 10 to 20 mg P/kg (table 7.2). The soils analyzed in Arkansas are primarily Alfisols and Ultisols with low organic P contents. The mineralization rate of organic P in these soils is probably low, which may explain the higher critical values in these soils. In Arkansas, Kansas, Minnesota, and Nebraska, the critical Bray I P concentration is higher for corn than for small grains. In Arkansas, Kansas, and Nebraska (but not in Minnesota), the critical Bray I P concentration is lower for soybeans than for corn.

Table 7.1
Minimum nitrogen and phosphorus soil data
requirements for each specified soil layer

Nutrient estimates	Other soil characteristics
<u>Nitrogen</u>	
Initial extractable nitrate plus ammonium	pH ¹
Organic N	
Organic C	
<u>Phosphorus</u>	
Labile P	Calcium carbonate
Organic P	Base saturation ²
Organic C	pH
Fertilizer P availability index	Clay content

¹ Determined on a 1:1 soil:water extract.

² Calculated as the sum of bases divided by the sum of cation determined by NH₄OAc extraction.

Table 7.2
Critical values of Bray-I soil test phosphorus from
various laboratories

Source	Soil or areas	Crops	Bray- I P	Comments
			mg P/kg	
Arkansas W.E. Sabbe	All (mostly Alfisolis and Ultisolis).	Corn, alfalfa, Small grains, grain sorghum, cotton, pasture grasses. Soybeans	33, 44 25, 33 12, 17	First value, 90% to 95% maximum yield. No P response expected above second value.
Illinois T.R. Peck	High subsoil P. Med. subsoil P. Low subsoil P.	Corn, soybeans	15, 20 15, 22.5 15, 25	Little or no response expected above first value. No corrective P recommended above second value.
Iowa R.D. Voss	All.	All.	20	Little or no response above this value. P fertilizer rate adjusted for subsoil P fertility.
Kansas D.A. Whitney	All (mostly Mollisolis).	Corn. Small grains, grain, sorghum, soybeans. Pasture grasses.	18, 30 15, 25 8, 25	Little or no response expected above first value. No P recommended above second value.
Minnesota W.E. Fenster	All (mostly Alfisolis and Mollisolis).	Corn, soybeans, alfalfa. Small grains, pastures. Potatoes.	15 10 25	Little or no P response above these values. If subsoil P is low add 5 mg P/kg to these values. Response to starter P likely even above these values.
Nebraska D. Knudsen	All (mostly Mollisolis).	Corn. Small grains. Grain sorghum, soybeans.	15, 25 10, 15 7, 10	Less than 50% chance of P response above first value. No P recommended above second value.
Oregon E.H. Gardner	Western Oregon. Southwestern Oregon.	Winter wheat, corn, crimson clover, vetch, subclover-grass pasture. Clover-grass pasture. Sweet corn. Alfalfa. Peas. Winter wheat. Clover-grass pasture, subclover- grass pasture, alfalfa	30 25 50 40 60 15 20	Adequate for 95% yield
South Dakota P.E. Fixen	Noncalcareous soils.	Small grains.	13, 20	Little or no response above first value. No P recommended above second value.

Table 7.3
Critical values of Olsen soil test phosphorus from
various laboratories

Source	Soil or areas	Crops	Olsen P	Comments
			mg P/kg	
California G. DeBoer	All.	Pastures and forages.	10	Little or no P response expected above these values.
		Warm season vegetables.	5	
		Cool season vegetables.	12	
Colorado D.G. Westfall	All	Corn, small grains, grain sorghum, sugar beet.	8, 11	Little or no P response expected above first value. No P recommended above second value.
		Alfalfa.	11, 15	
		Potatoes.	11	
Minnesota W.E. Fenster	Calcareous.	Corn, soybeans, alfalfa.	15	Little or no P response above these values. If subsoil P is low, add 5 mg P/kg to these values. Response to starter P likely even above these values.
		Small grains, pastures.	10	
		Potatoes.	25	
North Dakota W.C. Dahnke	All.	Wheat.	10	Little or no P response above this value.
Oregon E.H. Gardner	Central Oregon.	Small grain, wheat.	20	Adequate for 95% yield.
	Eastern Oregon.	Alfalfa.	15	
		Pasture, wheat, (irr.) corn.	12	
		Winter wheat.	10	
		Peas, maize (sweet corn).	20	
Washington A.R. Halvorson	All	Potatoes.	20	Little or no P response above these values.
		Other crops.	10	

Table 7.4
Critical values of Mehlich I soil test phosphorus
from various laboratories

Source	Soils	Crops	Mehlich-I P	Comments
			mg P/kg	
Alabama C.E. Evans	¹ CEC < 9. CEC > 9, acid.	All.	26 16	Little or no response expected above this value.
Georgia C.D. Planck	Sands, loamy sands, sandy loams. Sandy clays, sandy clay loams, silts, silt loams.	All.	30 20	Above this value P response expected in less than 10% of experiments.
North Carolina A.L. Hatfield	All.	All.	20, 50	Little or no response expected above first value. No P recommended above second value.

¹ cation exchange capacity.

Table 7.5
Critical values for other soil test
P methods

Source	Soils	Crops	Soil test P	Comments
			mg P/kg	
	<u>Mehlich III method</u>			
North Carolina A.L. Hatfield	All.	All.	30, 75	Little or no response expected above first value. No P recommended above second value.
	<u>Mississippi method</u>			
Mississippi J.D. Lancaster	All.	Rice. Other crops.	15 30	Little or no response expected above this value.
Alabama C.E. Evans	Calcareous.	All.	36	Little or no response expected above this value.
	<u>Texas A&M method</u>			
Texas C. Gray	All.	All.	15, 20	Less than 10% response expected above first value. Less than 5% response expected above second value.

In Illinois, Iowa, and Minnesota subsoil P is used to adjust either the critical Bray I P concentration or the fertilizer P recommendation. Much more information is needed about the status of subsoil P and its availability to crops in most areas throughout the United States.

The critical concentrations of Olsen P range from 8 to 15 mg P/kg for most crops (table 7.3). However, the critical concentrations for potatoes are as high as or higher than those of other crops in Colorado, Minnesota, and Washington. The critical concentrations for small grains agree well (8 or 10 mg P/kg), and this agreement is of major importance in most States using the Olsen method. The critical concentrations of Mehlich I P range from 16 to 30 mg P/kg (table 7.4). Georgia and Alabama soils with low clay contents and low cation exchange capacities have higher critical Mehlich I P concentrations than soils with higher clay contents and cation exchange capacities. However, in North Carolina, critical Mehlich I P concentration is not considered to vary among soils.

Critical concentrations for the Bray II (Louisiana), Mehlich III (North Carolina), Mississippi, and Texas A&M methods are given in table 7.5. Though these methods are not widely used, they may be available to EPIC model users in these States.

Some laboratories have different critical concentrations of soil test P for several crops and several groups of soils. Others vary critical concentrations among soils but not among crops, while yet others vary among crops but not among soils. The EPIC model allows for all these possibilities by allowing the user to specify the critical soil test P concentration for the crop and soil of interest. The model then estimates the fertilizer P required to both raise soil test P to the user-specified critical level (or some other concentration) and maintain that level over time. Tables 7.2-7.5 provide EPIC users with soil test P concentrations above which the probability of crop response to fertilizer P is small in several areas throughout the United States.

MODEL TESTING

The N and P models have been tested by comparing simulated results with results measured in a number of field experiments throughout the continental United States (Godwin and Jones 1986; Jones et al. 1984b and 1989; Sharpley et al. 1986). This testing has shown that accurate predictions of soil N and P cycling, plant uptake and yield, fertilizer requirements and residue incorporation can be obtained over long-term simulations (up to 50 years). Consequently, the only testing that will be presented is the long-term prediction of changes in organic

P, total N, and labile P in several Great Plains soils (table 7.6). Measured and simulated values after the period of cultivation were not significantly different at the 0.10 probability level (as determined by analysis of variance for paired data). Sensitivity analysis has shown that the slight overestimation of mean topsoil total N and organic P may be due in part to the fact that soil erosion (by water and wind) was kept minimal during the simulations.

Table 7.6
Measured and simulated changes in surface soil organic P, total N, and labile P, in the Great Plains¹

Location	Duration of study	Rotation ²	Organic P			Total N			Labile P		
			Cultivated			Cultivated			Cultivated		
			Virgin	Meas.	Sim.	Virgin	Meas.	Sim.	Virgin	Meas.	Sim.
	Years		-----mg/kg-----								
Havre, MT	31	SWF	157	102	108	1510	900	1135	11	13	15
Moccasin, MT	39	"	308	183	169	3000	2050	1787	14	14	20
Dickinson, ND	41	"	292	148	174	2930	1490	1957	10	12	14
Mandan, ND	31	"	139	132	97	1600	1160	1172	9	12	7
Sheridan, WY	30	"	120	93	86	1590	1210	1149	12	14	9
Laramie, WY	34	"	142	91	96	1220	820	900	13	24	9
Akron, CO	39	"	115	82	81	1340	800	911	26	45	19
Colby, KS	31	WWF	158	61	92	1650	1050	952	34	30	27
Hays, KS	30	W. Wheat	174	97	108	2200	1220	1360	11	40	8
Lawton, OK	28	"	128	71	73	1540	740	904	8	9	8
Dalhart, TX	29	Maize	84	39	53	670	420	444	17	13	9
Big Spring, TX	41	W. Wheat	55	30	29	600	410	328	12	12	6
Mean	34		156	94	97	1654	1023	1083	15	20	13

¹ Measured data from Haas et al. (1957 and 1961).

² SWF and WWF represent spring wheat-fallow and winter wheat-fallow, respectively.

CONCLUSIONS

The nutrient component model of EPIC produces realistic simulations of the effects of N and P on total uptake, grain concentration, and grain yield. In addition, transformations of N and P between labile and more stable pools are realistically simulated over long periods (up to 50 years). The accuracy of the nutrient component depends on the ability of the nonnutrient components to simulate growth and yield in the absence of nutrient deficiency and the accuracy with which initial soil conditions are measured or estimated. EPIC has many potential uses (Williams 1983). The nutrient component is particularly important for national, regional, and local assessments of the effects of erosion on crop production and costs of fertilizer inputs, for feasibility studies on development projects, and for predicting the results of transferring agricultural technology among sites with different soils.

ACKNOWLEDGMENTS

The authors appreciate the help of the following in providing information on critical P concentrations: D.E. Baker, The Pennsylvania State University, University Park, PA; B. DeBoer, University of California, Davis, CA; C.E. Evans, Auburn University., Auburn, AL; W.E. Fenster, University of Minnesota, St. Paul, MN; P.E. Fixen, South Dakota State University, Brookings, SD; E.H. Gardner, Oregon State University, Corvallis, OR; C. Gray, Texas Agricultural Experiment Station, College Station, TX; A.R. Halvorsen, Washington State University, Pullman, WA; A.L. Hatfield, North Carolina Department of Agriculture, Raleigh NC; D. Knudsen, University of Nebraska, Lincoln, NE; J.D. Lancaster, Mississippi State University, Mississippi State, MS; E.O. McLean, Ohio State University, Columbus, OH; T.R. Peck, University of Illinois, Urbana, IL; C.D. Planck, University of Georgia, Athens, GA; W.F. Sabbe, University of Arkansas, Fayetteville, AR; J.E. Sedberry, Jr., Louisiana State University, Baton Route, LA; R.D. Voss, Iowa State University, Ames, IA; D.G. Westfall, Colorado State University, Ft. Collins, CO; and D.A. Whitney, Kansas State University, Manhattan, KS.

REFERENCES

- Barrow, N.J., and E.D. Carter. 1978. A modified model for evaluating residual phosphate in soil. *Aust. J. Agric. Res.* 29:1011-1021.
- Bennett, D., and P.G. Ozanne. 1972. Australia, CSIRO Division of Plant Industry. Annual. Report. pp. 45.
- Bray, R.H., and L.T. Kurtz. 1945. Determination of total, organic and available forms of phosphorus in soils. *Soil Sci.* 59:39-45.
- Claassen, N., and S.A. Barber. 1974. A method for characterizing the relation between nutrient concentration and flux into roots of intact plants. *Plant Physiol.* 54:564-568.
- Cole, C.V., G.S. Innis, and J.W.B. Stewart. 1977. Simulation of phosphorus cycling in semiarid grasslands. *Ecology.* 58:1-15.
- Cox, F.R., E.J. Kamprath, and R.E. McCollum. 1981. A descriptive model of soil test nutrient levels following fertilization. *Soil Sci. Soc. Am. J.* 45:529-532.
- Godwin, D.C., and C.A. Jones. 1986. Nitrogen dynamics in soil-plant systems: The CERES model. Chapt. 14. *In*. D.C. Godwin, C.A. Jones, J.T. Ritchie, P.L.G. Vlek and L.G. Youndahl. 1984. The water and nitrogen components of the CERES models. pp. 101-106. ICRISAT (International Crops Research Institute for the Semi-Arid Tropics). Proc. Int. Symp. on Minimum Data Sets for Agrotechnology Transfer, March 21-26, 1983. ICRISAT Center, India, Patancheru, A. P. 502 324, India, ICRISAT.
- Harrison, A.F. 1978. Phosphorus cycles of forest and upland grassland systems and some effects of land management practices. pp. 175-195. *In* Phosphorus in the Environment: Its Chemistry and Biochemistry. CIBA Foundation Symp., 57, Amsterdam, Elsevier/North-Holland.
- Jones, C.A. 1983. A survey of the variability in tissue nitrogen and phosphorus concentrations in maize and grain sorghum. *Field Crops Res.* 6:133-197.
- Jones, C.A., and J. Kiniry. (eds.) 1986. CERES-Maize: A simulation model of maize growth and development. Texas A & M University Press, College Station, Texas.
- Jones, C.A., C.V. Cole, A.N. Sharpley, and J.R. Williams. 1984a. A simplified soil and plant phosphorus model: I Documentation. *Soil Sci. Soc. Am. J.* 48:800-805.

- Jones, C.A., A.N. Sharpley, and J.R. Williams. 1984b. A simplified soil and plant phosphorus model: III Testing. *Soil Sci. Soc. Am. J.* 48:810-813.
- Jones, C.A., A.N. Sharpley, and J.R. Williams. 1989. Modeling phosphorus dynamics in soil-plant systems. In R.J. Hanks and J.T. Ritchie, (eds). *Modeling Soil and Plant Systems*. Am. Soc. Agron. Monograph., Madison, WI (in press).
- Kamprath, E.J., and M.E. Watson. 1980. Conventional soil and tissue tests for assessing the phosphorus status of soils. pp. 433-469. In F. F. Kasawneh, E.C. Sample and E.J. Kamprath (eds.), *The Role of Phosphorus in Agriculture*. Am. Soc. Agron., Crop Sci. Soc. Am., Soil Sci. Soc. Am., Madison, WI.
- Mishra, B., P.K. Khanna, and B. Ulrich. 1979. A simulation model for organic phosphorus transformation in a forest soil ecosystem. *Ecol. Model.* 6:31-46.
- Nelson, L.A., and R.L. Anderson. 1977. Partitioning of soil test crop response probability. pp. 19-38. In T.R. Peds, J.D. Cope, Jr., and D. A. Whitney (eds.), *Soil Testing Correlating and Interpreting Analytical Results*. ASA Special Publication No. 29.
- North Carolina Department of Agriculture. 1982. Soil testing methods used by the Agronomic Division (unpublished mimeo).
- Olsen, S.R., C.V. Cole, F.S. Watanabe, and L.A. Dean. 1954. Estimation of available phosphorus in soils by extraction with sodium bicarbonate, U.S. Dep. Agric. Circ., 939.
- Parton, W.J., J. Persson, and D.W. Anderson. 1983. Simulation of soil organic matter changes in Swedish soils. pp. 511-516. In U.K. Lavenroth, C.V. Skugerboe, and M. Flug (eds.) *Analysis of Ecological Systems: State-of-the-Art in Ecological Modeling*. Elsevier Scientific Publ. Co., Amsterdam.
- Penning de Vries, F.W.T. 1980. Simulation models of growth of crops particularly under nutrient stress. In *Physiological Aspects of Crop Productivity*. Proc. 15th Colloq. Int. Potash Inst., Wagennigen, The Netherlands.
- Rolsten, D.E., A.N. Sharpley, D.W. Toy, D.L. Hoffman, and F.E. Broadbent. 1980. Denitrification as affected by irrigated frequency of a field soil. U.S. Environmental Protection Agency Report No. 600/2-80-06, Ada, OK.
- Sabbe, W.E., and H.L. Breland. 1974. Procedures used by state soil testing laboratories in the southern region of the United States. *South Coop. Ser. Bull.* 1980.

Seligman, N.G., and H. Van Keulen. 1981. PAPRAN: A simulation model of annual pasture production limited by rainfall and nitrogen. pp. 192-221. In Simulation of Nitrogen Behaviour of Soil-Plant Systems. PUDOC, Wageningen, The Netherlands.

Sharpley, A.N., C.A. Jones, C. Gray, and C.V. Cole. 1984. A simplified soil and plant phosphorus model. II. Prediction of labile, organic, and sorbed phosphorus. Soil Sci. Soc. Am. J. 48:805-809.

Sharpley, A.N., S.J. Smith, J.R. Williams, and C.A. Jones. 1986. Simulation of Soil Formation and Degradation Processes. In Proc. of First Int. Geomorphology Conference, Manchester, England. September, 1985. Part II 495-506. Publ. by J. Wiley and Sons.

Soil Test Laboratories in the Southern Region of the United States. 1974. Procedures used by State soil testing laboratories in the southern region of the United States. South. Coop. Ser. Bull. 190.

Smith, K.A. 1981. A model of denitrification in aggregated soils. pp. 259-266. In Simulation of Nitrogen Behavior of Soil-Plant Systems. Centre for Agric. Pub. and Documentation. Wageningen, The Netherlands.

Tejeda, H., D.C. Godwin, and S.S. Sidhu. 1981. Conceptual models for maximizing fertilizer use efficiency. In Strategies for Achieving Fertilizer Consumption Targets and Improving Fertilizer Use Efficiency. II-(1):1-26. New Delhi: Fertilizer Assoc. of India.

Texas Agricultural Extension Service. 1983. Soil test procedures manual. (unpublished mimeo).

Watts, D.G., and R.J. Hanks. 1978. A soil-water-nitrogen model for irrigated corn on sandy soils. Soil Sci. Soc. Am. Proc. 42:492-499.

Williams, J.R. 1983. The physical components of the EPIC model. In Soil Erosion and Conservation. Soil Conserv. Soc. Am., Ankeny, IA. pp. 272-284.

8. ESTIMATION OF SOIL pH CHANGES IN EPIC

S.J. Smith, A.D. Nicks, and A.N. Sharpley

ABSTRACT

This chapter concerns the use of soil chemical and applied amendment parameters in EPIC to estimate changes in soil pH associated with different management strategies. The calculation involves the use of a compositive curve based on a general relationship between pH and percent base saturation of the soil. Considered also is the possible role of acid rainfall. For a range of soils, predicted soil pH changes compared favorably to field measured changes.

INTRODUCTION

Soil pH changes are an important factor in EPIC predictions of soil fertility and productivity because pH strongly influences plant nutrient availability and the solubilities of elements that are potentially toxic to plants. Generally, a soil pH range of 6.0 to 7.0 is satisfactory for field crop production (table 8.1).

Table 8.1
Suitable soil pH for common crops

Crops	pH range
<u>Nonlegumes</u>	
Bermudagrass	5.5 - 7.5
Corn	6.0 - 7.5
Cotton	6.0 - 8.0
Sorghum	5.5 - 7.0
Sugar beets	7.0 - 8.0
Wheat	5.5 - 7.0
<u>Legumes</u>	
Alfalfa	6.5 - 8.0
Lespedeza	5.0 - 6.5
Red and white clover	6.0 - 7.0
Soybeans	5.5 - 7.0

From Johnson and Tucker (1979) and Welch (1974).

The amount of rainfall, the soil texture, and mineral base content all influence soil pH. Humid and subhumid, well-drained, noncalcareous soils under good management slowly tend to become more acidic as a natural consequence of high crop production and commercial fertilizer application (Johnson and Tucker 1979). Noncalcareous soils, unlike calcareous soils, generally do not have enough mineral base reserve to maintain a satisfactory soil pH under extended cropping. A major factor contributing to the soil pH decline is the acidic residue associated with commercial fertilizer application. The potential acidity of various specific fertilizer materials is listed in table 8.2. For complete fertilizers, the potential acidity can be found on the bag or an authorized tag. This chapter concerns the use of soil, chemical, and applied amendment parameters in EPIC to predict changes in soil pH associated with different management practices. The possible role of acid rainfall is considered also.

Table 8.2
Composition and potential acidity of principal fertilizer materials

Material	N	P ₂ O ₅	K ₂ O	Ca	Mg	S	Cl	Approx. lime equivalent
	----- % -----							lb CaCO ₃ /ton
NITROGEN								
Ammonia, anhydrous	82	--	--	--	--	--	--	-2,960
Ammonia, aqua	16-25	--	--	--	--	--	--	-720 to -1,080
Ammonium nitrate	33.5	--	--	--	--	--	--	-1,180
Ammonium nit.-lime-stone mixtures	20.5	--	--	7.3	4.4	0.4	0.4	0
Ammonium sulfate	21	--	--	0.3	--	23.7	0.5	-2,200
Ammonium sulfate-nitrate	26	--	--	--	--	15.1	--	-1,700
Calcium cyanamide	21	--	--	38.5	0.06	0.3	0.2	+1,260
Calcium nitrate	15	--	--	19.4	1.5	0.02	0.2	+ 400
Nitrogen solutions	21-49	--	--	--	--	--	--	-750 to -1,760
Sodium nitrate	16	--	0.2	0.1	0.05	0.07	0.4	+ 580
Urea	46	--	--	--	--	--	--	-1,680
Urea-form	38	--	--	--	--	--	--	-1,360
PHOSPHATE								
Basic slag, open hearth	--	8-12	--	29	3.4	0.3	--	+1,000
Bone meal	2-4.5	22-28	0.2	20-25	0.4	0.1	0.2	+400 to +500
Phosphoric acid	--	52-60	--	--	--	--	--	-1,000 to -1,400
Rock phosphate	--	30-36	--	33.2	0.2	0.3	0.1	+ 200
Superphosphate, normal	--	18-20	0.2	20.4	0.2	11.9	0.3	0
Superphosphate, concentrated	--	42-50	0.4	13.6	0.3	1.4	--	0
Superphosphoric acid	--	69-76	--	--	--	--	--	0

Table 8.2--Continued
Composition and potential acidity of principal fertilizer materials

Material	N	P ₂ O ₅	K ₂ O	Ca	Mg	S	Cl	Approx. lime equivalent
----- % -----								lb CaCO ₃ /ton
POTASH								
Potassium chloride	--	--	60-62	0.1	0.1	--	47	0
Potassium magnesium sulfate	--	--	22	--	11.2	22.7	1.5	0
Potassium sulfate	--	--	50	0.7	1.2	17.6	2.1	0
MULTIPLE NUTRIENT								
Ammoniated super-phosphate	3-6	18-22	--	17.2	--	12	--	-140
Ammonium phosphate-nitrate	27	15	--	--	--	--	--	-1,240
Ammonium phosphate-sulfate	13-16	20-39	0.2	0.3	0.1	15.4	0.1	-1,520 to -2,260
Cotton hull ashes	--	4.7	22-30	6.8	3.1	1.0	1.9	+
Diammonium phosphate	16-21	48-53	--	--	--	--	--	-1,250 to -1,550
Monoammonium phosphate	11	48	0.2	1.1	0.3	2.2	0.1	-1,300
Nitric phosphates	14-22	10-22	--	8-10	0.1	0.2-3.6	1-12	-300 to -500
Nitrate of soda-potash	15	--	14	--	--	--	0.5	+ 500
Potassium nitrate	13	--	44	0.6	0.4	0.2	1.1	+ 520
Wood ashes	--	1.8	5.5	23.3	2.2	0.4	0.2	+
Blast furnace slag	--	1.7	0.6	29.3	3.8	1.4	--	+
Dolomite	--	--	--	21.5	11.4	0.3	--	+1,960
Gypsum	--	--	0.5	22.5	0.4	16.8	0.3	0
Kieserite (emjeo)	--	--	--	1.6	18.2	--	--	0
Limestone	--	--	0.3	31.7	3.4	0.1	--	+1,800
Lime-sulfur solution	--	--	--	6.7	--	23.8	--	-
Magnesium sulfate (Epsom salt)	--	--	--	2.2	10.5	14	0.4	0
Sulfur	--	--	--	--	--	30-99.6	--	-1,900 to -6,320

From Slack (1976) with permission of the Fertilizer Institute, Washington, D.C. Farm manures are considered to have a pH around neutrality (Adriano 1975; Meek et al. 1975) and little effect on soil pH (Smith et al. 1980). If necessary, pH decisions regarding pesticide application should be made on a case by case basis.

METHOD

To predict soil pH change requires a knowledge of both the initial pH and the soil mineral base reserve. The method employed here to predict pH utilizes a composite curve (Peech 1965) based on a general relationship between soil pH and the percent base saturation of the soil (figure 8.1). This method was selected because it allows the lime requirement to be calculated from one easily measured parameter, soil pH, plus an estimate of cation exchange capacity, which is usually available for specific soils from the literature.

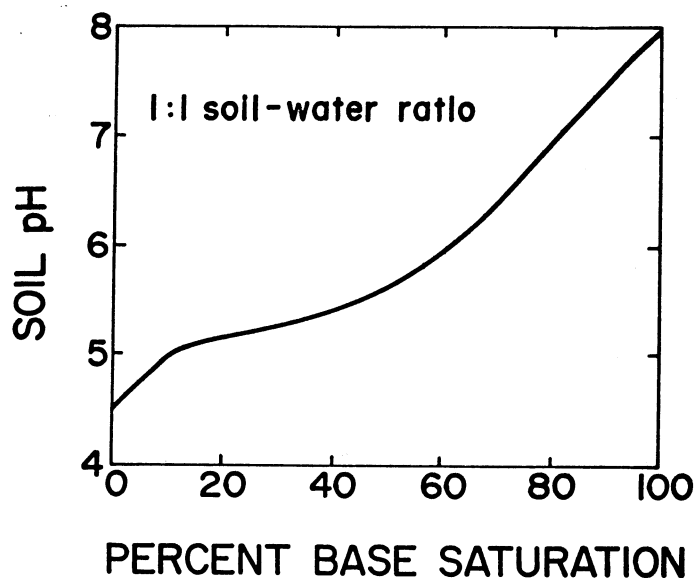

Figure 8.1
General relationship between soil pH and percent soil base saturation (adapted from Peech 1965)

Percent base saturation is calculated as follows:

$$\% \text{ Base saturation} = \text{BEC} / \text{CEC} * 100 \quad [8.1]$$

where BEC is the soil base exchange and CEC is the soil cation exchange capacity. To illustrate how the change in the pH value of a soil can be estimated, the following example is given. Suppose the pH of a soil is 6 and CEC is 20 meq/100 g. How much lime will be required to bring the plow layer (0-6 inches) to pH 7? According to figure 8.1, the base saturation must increase from 63% to 80%. The lime requirement equation is as follows:

$$\text{LR} = \text{CEC} (\text{BSL}_{\text{Final}} - \text{BSL}_{\text{Initial}}) * 1000 \quad [8.2]$$

where

- LR = lime required (CaCO_3 equivalent) in pounds/acre,
- CEC = cation exchange capacity, meq/100 g,
- BSL = percent base saturation level, expressed as a decimal, and
- 1000 = a constant to account for the fact that 1 meq/100 g exchange acidity is equivalent to 1,000 pounds of CaCO_3 /2 million pounds of soil (6-inch soil layer).

Therefore, it follows for the example that

$$LR = 20(0.80 - 0.63) * 1000 = 3,400 \text{ lb lime/acre} \quad [8.3]$$

Usually soil pH changes associated with acidity of rainfall are not important. This is because the acid contribution is generally negligible. Nevertheless, there is considerable current interest in the overall environmental impact of acid rain (U.S. Environmental Protection Agency 1980). If acid rainfall contributions to soil are desired the following equation may be used:

$$H = 10^{-pH} * RA * 226 \quad [8.4]$$

where

H = pounds acid equivalent/acre
pH = rainfall pH
RA = inches of rainfall
226 = conversion constant for pounds/acre
expression

As an example, a 30-inch annual rainfall with an average pH of 5, yields 0.068 pound acid equivalent/acre.

PROGRAM

For specific application of this method to EPIC, a subroutine and mainline program were written to illustrate the utility in estimating the status of soil pH. The mainline program (PHMODEL) is used as a driver for the subroutine PHBSL. PHBSL could be interfaced to any model which deals with chemical properties of soil or to any chemical transport model, such as CREAMS (Knisel 1980). The mainline program and subroutine are listed in the appendix.

The soil and chemical parameters required to run the model are readily available to the user. Required inputs are the number of fertilizer and lime applications during the investigation period, rate (lb/acre) of equivalent fertilizer acidity, date of application (year), soil CEC, initial soil pH, soil CaCO₃ content (%), and depth of incorporation into the soil for lime and fertilizer (inches).

Both the purity and particle size of applied lime determine its effectiveness. For the model here, an agricultural lime application efficiency of 0.6 (Baker and Tucker 1973) is used to determine effective lime from the applied amount. The soil base saturation level (BSL) - pH relationship shown in figure 8.1 is entered into the model as a table representing ten 0.10

percentiles of the range in BSL's shown. Linear interpolation is used to calculate pH and BSL values between percentile entries. A soil incorporation depth of 6 inches is used as a reference in the model for calculation of soil lime content. However, the user may specify a depth greater or shallower than 6 inches. The model will calculate a proportional adjustment according to the ratio of the user-entered incorporation depth to the 6-inch reference depth. Also, if necessary, a provision may be incorporated into the model to account for Ca removal from the soil by the crop.

Soil parameter data are available from Soil Conservation Service publications, such as "Soil Sheets and Soil Survey Laboratory Data" (U.S. Department of Agriculture, Soil Conservation Service 1967). General information regarding liming materials and application rates can be obtained from State and County extension services and from State experiment station bulletins, fact sheets, etc.

TEST RESULTS

Limited testing of the subroutine PHBSL has been made using the PHMODEL and data from several soils located in different land resource regions of the United States. Soil pH data were available for virgin and cultivated sites in Oklahoma (Bethany clay loam), Mississippi (Dundee silt loam) and Texas (Houston Black clay). Field samples for these soils were obtained and analyzed by our laboratory. Also, the cultivation and fertilizer management history for each soil was obtained. Then, the model was tested, using the parameters and information from these soils.

Table 8.3 lists the comparison between model estimates and field sample test data. The model accurately estimated the changes in pH status of these soils, due to cultivation and fertilizer management.

Results of the model runs for these three soils indicate the method has predictive value when used in conjunction with typical soil data and management history. The three soils used in this evaluation of the model illustrate how the model can be used. For instance, the Houston Black clay soil is high in CaCO_3 , and addition of fertilizer does not change the soil pH. The model adequately handled this calcareous soil and fertilizer management. For the Bethany soil, the model predicted a 0.56 pH unit decrease, which compares closely with field sample analysis. This run typifies the results that would be expected for many of the soils in the hard red winter production area. Results from two runs on the Dundee soil exemplify the model operation using fertilizer application with and without lime application for pH maintenance in the Mississippi Delta.

Table 8.3
 Comparison of model estimates (PHMODEL)
 of changes in soil pH (0- to 6-inch
 surface layer) and field sample
 measurements

Soil and land resources region	No. years managed	Model est. pH		Field meas. pH	
		Vir.	Cult.	Vir.	Cult.
Bethany clay loam Central Great Plains	38	5.6	5.04	5.6	5.0
Houston Black clay Southwestern Prairies	25	7.4	7.4	7.4	7.4
Dundee silt loam Mississippi Delta	39	6.2	5.8	6.2	5.7

REFERENCES

- Adriano, D.C. 1975. Chemical characteristics of beef feedlot manure as influenced by housing type. *In* Managing Livestock Wastes. Am. Soc. Agric. Eng. St. Joseph, MI. pp. 347-350.
- Baker, J.M., and B.B. Tucker. 1973. Fertilizer recommendation guide. Okla. St. Univ. Extension Fact Sheet 2225, Stillwater, OK.
- Johnson, G., and B. Tucker. 1979. OSU Soil Test Interpretation: 1. pH and Buffer Index. Okla. St. Univ. Extension Fact Sheet No. 2229, Stillwater, OK.
- Knisel, W.G. (editor). 1980. CREAMS: A field-scale model for chemicals, runoff, and erosion from agricultural management systems. U.S. Dep. Agric. Conserv. Res. Rept. No. 26.
- Meek, B., L. Chesnin, W. Fuller, R. Miller, and D. Turner. 1975. Guidelines for manure use and disposal in the western region. USA. Bulletin 814. College of Agriculture, Washington State University, Pullman.
- Peech, M. 1965. Lime requirement. *Agronomy* 9:927-932.
- Slack, A.V. 1976. Fertilizer products. *In* The Fertilizer Handbook. Second Edition. pp. 47-63, The Fertilizer Institute, Washington, DC.

Smith, S.J., A.C. Mathers, and B.A. Stewart. 1980.
Distribution of nitrogen forms in soil receiving cattle feedlot
waste. J. Environ. Qual. 9:215-218.

U.S. Department of Agriculture, Soil Conservation Service.
1967. Soil survey laboratory data and description for some
soils of Oklahoma. Soil Survey Investigations Report No. 11.

U.S. Environmental Protection Agency. 1980. Acid Rain. U.S.
Environmental Protection Agency Report No. 600/9-79-036.

Welch, C.D. 1974. Soil reaction (pH). L-164. Texas
Agricultural Extension Service, College Station, TX.

APPENDIX

```
C      PROGRAM MAIN TO COMPUTE SOIL PH CHANGE FROM FERTILIZER
      APPLICATION
C      WRITTEN 08/23/82 ADN DURANT OK
C      PHI - INITIAL SOIL PH
C      PHF - FINAL SOIL PH
C      CA03 - POTENTIAL ACIDITY (LBS./AC CAC03 EQUIV.)
C      SLC - SOIL CALCIUM CARBONATE IN PERCENT
C      RL - REQUIRED LIME EQUIVLENT (LBS/AC)
C      DR - DEPTH OF INCORPORATION (INCHES)
C      BSLI - INITIAL BASE SATURATION LEVEL OF SOIL
C      BSLF - FINAL BASE SATURATION LEVEL OF SOIL
C      CEC - CATION EXCHANGE CAPACITY (MEQ/100G)
C      AL - LIME APPLICATION RATE (LB/AC)
C      AF - FERTILIZER APPLICATION RATE (LB/AC)
C      ALEF - LIME APPLICATION EFFICIENCY - .6
C      RA - ANNUAL RAINFALL
C      PHR - PH OF ANNUAL RAINFALL
      DIMENSION NYF(50), NYL(50), A(50), AL(50)
      COMMON/BLK1/BS(12), TITLE(40)
      DATA BS/4.5,4.9,5.1,5.2,5.35,5.5,5.9,6.4,7.05,7.6,
      7.95,8.2/
      WRITE(5,51)
51     FORMAT(1X,' ENTER UNIT NUMBER FOR OUTPUT 5-SCREEN
      2- PRINT '/')
      READ(3,501)KW
501    FORMAT(I2)
      WRITE(5,52)
52     FORMAT(1X,'ENTER TITLE INFORMATION LOCATION SOIL SERIES,
      ETC. '/')
      READ(3,14)TITLE
14     FORMAT(40A2)
      WRITE(5,53)
```

```

53      FORMAT(1X,'ENTER THE NUMBER OF YEARS TO SIMULATED &
        1ST YEAR'/)
        READ(3,502)NYR,NY
502     FORMAT(2I2)
        WRITE(5,554)
554     FORMAT(1X,'ENTER ANNUAL RANIFALL AND PH',/)
        READ(3,552)RA,PHR
552     FORMAT(2F5.0)
        WRITE(5,54)
54      FORMAT(1X,' ENTER NUMBER OF FERTILIZATIONS'/)
        READ(3,501)NF
        WRITE(5,56)
56      FORMAT(1X,'ENTER DATE(YEAR) AND RATE OF FERTILIZATION'/)
        WRITE(5,57)
57      FORMAT(1X,' YEAR           LBS/AC ACIDITY EQUIV.'/)
        DO 100 I=1,NF
100     READ(3,504)NYF(I),AF(I)
504     FORMAT(12,F4,0)
        WRITE(5,58)
58      FORMAT(1X,' ENTER NUMBER OF LIME APPLICATIONS'/)
        READ(3,501)NL
        WRITE(5,59)
59      FORMAT(1X,' ENTER YEAR, RATE OF LIMING LB/AC'/)
        DO 101 I=1,NL
101     READ(3,504)NYL(I),AL(I)
        WRITE(5,601) 601      FORMAT(1X,' PHI - INTIAL SOIL PH')
        WRITE(5,602)
602     FORMAT(1X,' DR - DEPTH OF INCORPORATION')
        WRITE(5,603)
603     FORMAT(1X,' CEC - CATION EXCHANGE CAPACITY')
        WRITE(5,604)
604     FORMAT(1X,' SLC - SOIL CALCIUM CARBONATE CONTENT AS
        PERCENT')
        WRITE(5,605)
605     FORMAT(1X,' ALEF-LIME EFFICIENCY')
        WRITE(5,606)
606     FORMAT(1X,' ENTER PHI,DR,CEC,SLC,ALEF'/)
        READ(3,503)PHI,DR,CEC,SLC,ALEF
503     FORMAT(5F10.0)
        WRITE(KW,16)TITLE
16      FORMAT(1X,40A2,/)
        WRITE(KW,3)PHI,DR,CEC,SLC
3       FORMAT(10X,'INITIAL PH =',F5.2,2X,'INC. DEPTH =',F5.2,/
1       10X,'CEC           =',F5.2,2X,'% SOIL LIME =',F5.1/
2       10X,'ANN. RAIN   =',F5.2,2X,'RAIN PH   =',F5.1/
        WRITE(KW,44)
44      FORMAT(1X,'FERTILIZER APPLICAITON DATE AND RATES
        (LB/AC))
        WRITE(KW,45)(NYF(I),AF(I),I=1,NF)
45      FORMAT(1X,I3,F8.1)
        WRITE(KW,46)

```

```

46      FORMAT(1X,'LIME APPLICATION DATE AND RATE (LB/AC)')
        WRITE(KW,45)(NYF(I),AL(I),I=1,NL)
        WRITE(KW,4)
4        FORMAT(1X,'YEAR      BSLI      BSLF      PHI      PHF      TOTL
SLM'      1'      ALM      SLC')
        SLM=SLC*2.0E6*DR/6.0
        PHME=10.0**(-PHR)
        H=PHME*RA*2.2641E02
        TOTL=0.0
        K=1
        ALM=AL(K)*ALEF
        CA03=AF(K)+H
        K=K+1
        L=K
        DO 10 I=1,NYR
        ALM=0.0
        IF(NYF(K).NE.NY) GO TO 60
        CA03=AF(K)+H
        K=K+1
60      IF(NYL(L).NE.NY) GO TO 61
        ALM=AL(L)*ALEF
        L=L+1
61      SLC=SLM/(2.0E6*DR/6.0)
        SLM=SLM+ALM
        IF(CA03.LE.AL) GO TO 6
        IF(CA03.GT.SLM) GO TO 7
        RL=0.0
        SLM=SLM-CA03
        TOTL=0.0
        GO TO 5
7        RL=CA03-SLM
        TOTL=TOTL+RL
        GO TO 5
6        RL=CA03-SLM
        SLM=0.0
        TOTL=0.0
5        CALL PHBSL(PHI,BSL,1)
        BSLI=BSL
        BSLF=BSLI-(RL/(1000.*(DR/6.0)*CEC))
        IF(BSLF.GT.1.0) BSLF=1.0
        CALL PHSBL(PH,BSLF,0)
        PHF=PH
        WRITE(KW,2)NY,BSLI,BSLF,PHI,PHF,TOTL,SLM,ALM,SLC
        BSLI=BSLF
        PHI=PHF
        NY=NY+1
10      CONTINUE
        WRITE(KW,1000)
1000    FORMAT(1X,///)
2        FORMAT(1X,I3,5F8.2,F10.0,F8.1,F8.4)
        END

```

```

C      SUBROUTINE TO CALCULATE SOIL PH AND BASE SATURATION
      LEVEL
C      WRITTEN 8/23/82 ADN DURANT OK
      SUBROUTINE PHBSL(PH,BSL,L)
      COMMON /BLK1/BS(12)
      IF(L.GT.0) GO TO 1
      IBA=BSL*10.
      IF(IBA.LT.11) GO TO 4
      PH=8.2
      GO TO 5
4      BSL1=IBA*.10
      BSL2=BSL1+.10
      IBA=IBA+1
      DEL=BS(IBA+1)-BS(IBA)
      DELB=(BSL-BSL1)/(BSL2-BSL1)*DEL
      PH=BS(IBA)+DELB
      IF(PH.LE.4.6) PH=4.6
5      RETURN
C      IF L=1 BSL IS CALCULATED
1      DO 10 I=1,12
      IF(PH.LE.4.6) GO TO 15
      IF(PH.GT.BS(I)) GO TO 10
      IBA=I-1
      GO TO 12
10     CONTINUE
12     BSL=IBA-1
      IF(BSL.LT.11.) GO TO 14
      BSL=1.0
      GO TO 20
14     BSL=BSL*.10+(.10*(PH-BS(IBA))/(BS(IBA+1)-BS(IBA)))
      RETURN
15     BSL=.02
20     RETURN
      END

```

9. A SENSITIVITY ANALYSIS OF EPIC

D.T. Favis-Mortlock and F.R. Smith

ABSTRACT

A sensitivity analysis of EPIC was undertaken to identify those EPIC inputs which, when modified, produce important changes in the value of the outputs. Most of the work was carried out on a data set for the Houston Black soil series from Bell, TX. The aim was to identify particularly sensitive inputs. Modification of one input--runoff curve number for moisture condition 2--resulted in large changes in all outputs. Minimum temperature and its effect on crop stress particularly affected N balance. Changes in other inputs, however, had negligible effects on outputs. Smaller scale tests on other data sets showed a broad correspondence of input sensitivities. The chapter includes recommendations for EPIC users based upon interpretation of the results.

INTRODUCTION

EPIC is being used to simulate soil loss processes at selected sites on the English South Downs as part of ongoing research into causes and effects of soil erosion by water in England. Before EPIC was used, a sensitivity analysis of input parameters was undertaken to determine which inputs, when modified by a small (but known) amount produce the greatest change in the outputs. This, in turn, enables a decision to be made regarding which inputs in an EPIC data set need to be specified with the greatest precision. The abridged results of the analysis are presented here so that other workers may build EPIC data sets that lead to accurate predictions.

ANALYTICAL METHODS

A sample data set for Bell, TX, was selected for the main part of the analysis, which was made with the 6-27-84 version of EPIC running on a DEC VAX minicomputer cluster. The data set was for the Houston Black soil series, simulating the relation between erosion and the productivity of soil planted with cotton, grain sorghum, and wheat grown in a 3-year rotation. The definition of each abbreviated variable is given in the "Notations" section of this chapter.

Each EPIC input for this data set was modified in turn by alternately increasing and decreasing its value by +10% and -10%. This percentage change was considered a realistic measure of the likely inaccuracy of the value of many EPIC inputs. Such inaccuracy could result from inherent variability in the property measured or from the application of data not wholly representative of a simulation site. A total of 568 5-year simulations were carried out with the Bell data set, each with the value of only one input changed from the original. The

effect of this change was then noted on seven EPIC outputs: soil loss, runoff volume, cotton yield, grain sorghum yield, wheat yield, N balance, and P balance.

Some inputs could not be modified by +10% and -10%. For example, input dates of tillage operations (MT/IT) must be integers; hence tillage dates were alternately amended by +3 and -4 days. This again was considered a realistic measure of the likely inaccuracy in specifying a value for these data. A small number of inputs with fixed or zero values could not be amended and were, thus, not tested. Wind erosion inputs were also not tested. No attempt was made to modify more than one input per simulation.

The outputs from the simulations were processed as follows:

(a) Percentage change produced was calculated for each of the seven selected outputs. Calculation of percentages enabled direct comparison of changes among all outputs, irrespective of the original units of measurement. For this report, the direction of change produced in the outputs is ignored.

(b) Modification of each input time by +10% and -10%, produced two values for change in each of the seven outputs. Of these two input values the one producing the larger change in output value was selected for evaluation.

(c) Some inputs required a value for each month, which is indicated parenthetically by numbers (e.g., P5MX(1) to P5MX(12)), or for each soil layer (e.g., RSD(1) to RSD(9)). Here the value which produced the greatest percentage change in any of the seven outputs was selected. This became the value for the whole of the set (i.e., for P5MX or RSD). These three procedures reduced the original 568 inputs to 57.

(d) The simulations carried out for the three crops in the Bell data set (cotton, grain sorghum, and wheat) produced three sets of results for change in yield. The largest value for change in yield was selected to produce a new output category (crop yield).

The number of outputs considered was, thus, reduced to five: soil loss, runoff volume, crop yield, N balance, and P balance. A further three data sets (for Maricopa, AZ; Escambia, AL; and Ellis, KS) were used in simulations, and the results from the simulations for all four data sets were compared. For these tests, one input was randomly selected from each of the sensitivity categories in table 9.1. In addition, two new inputs (BIR and EFI) were tested in the Maricopa data set for irrigated crops. It had not been previously possible to test these inputs because the Bell data sets applied to nonirrigated crops. Results from the EPIC simulations for the three new data sets, which were smaller than the Bell data set, were processed in the same way as those from simulations for the Bell data set.

Table 9.1
 EPIC inputs for the Bell data set placed
 into sensitivity categories

EPIC input data item	% variation caused in output ¹	EPIC input data item	% variation caused in output ¹
CN2	75.0	P5MX	
-----	-----	CRMP (AMP)	
TMN		RST (3)	1.0-1.9
CTSN (AMP)		CTS (AMP)	
CTMN (AMP)	20.0-74.9	CTMP (AMP)	
CTMN (MEAN)		-----	
CTSN (MEAN)		TD	
-----	-----	TP24	
PW/W		TP5	0.5-0.9
CRM (MEAN)		SALB	
FC	10.0-19.9	WN	
PW/D		CBN	
Z		-----	
-----	-----	TP6	
RZ		SN	
BD		DA	
TMX	5.0-9.9	SL	
WT		RTN	
S		SAN	
IT		RCN	
-----	-----	WN03	0.5
RAIN		RSD	
CRM (AMP)		AP	
CTM (MEAN)	3.0-4.9	CHS	
YLT		CHN	
RST (2)		CHL	
EP		PH	
-----	-----	CAC	
APM		ZMX	
CRMP (MEAN)	2.0-2.9	BFT	
CTS (MEAN)			
-----	-----		
CTMP (MEAN)			
SIL	1.0-1.9		
CTM (AMP)			

¹ Mean change for 5 outputs.

RESULTS

When modified by 10%, several of the EPIC inputs for the Bell data set produced large changes in output values (figure 9.1). Only those inputs which produced a change of at least 1% (measured over the five outputs) are presented in the figure.

A small change in the value of CN2 for the Bell data set, specified for CN2, caused a considerable corresponding change in the values of all five outputs. CN2 is, thus, the most sensitive input for the data set when procedures (a) to (d) outlined above are followed. Changes in the values of TMN, CTSN(AMP), CTMN(AMP), CTMN(MEAN), and CTSN(MEAN) produced large changes only in the output value for the N balance. Changes in the values of PW/W, CRM(MEAN), FC, PW/D, and Z produced moderate to small changes in the values of all five outputs. For most of the inputs in the Bell data set, however, a 10% change in value produced only a small corresponding change in the values of the five outputs considered (table 9.1). All inputs for the Bell data set are listed in the table.

A comparison of the results obtained from simulations made with the Bell, Maricopa, Escambia, and Ellis data sets, suggests a broad correspondence in the relative sensitivities of the inputs tested (cf. figures 9.1, 9.2, 9.3, and 9.4). No result could be derived for percentage change in the value of runoff volume for the Ellis data set, because all values for this output were zero. Data sets appear to differ, however, in overall sensitivity of the input data. For example, the very large changes produced in the N balance output for the Maricopa data set by changes to RZ and CTSN(MEAN) (figure 9.2) are in strong contrast to the small changes produced by even the most sensitive inputs in the Ellis data set (figure 9.4).

DISCUSSION

This study emphasizes the relative, rather than the absolute, sensitivity of each EPIC input under consideration. The methods adopted for processing the data were chosen to maximize the output change produced by a change in the input (see procedure (b) above). Also, for any input requiring a set of values, one or two individual values will produce greater change in the output value than the remainder of the set (see procedure (c) above). And it is these maximal percentage changes that are shown in figures 9.1 - 9.4.

The results obtained here refer primarily to the application of specific procedures to the Bell data set. The study raised the important issue of the extent to which generalizations based on the behavior of the Bell data set would be applicable to other data sets. Our limited testing of the Maricopa, Escambia, and

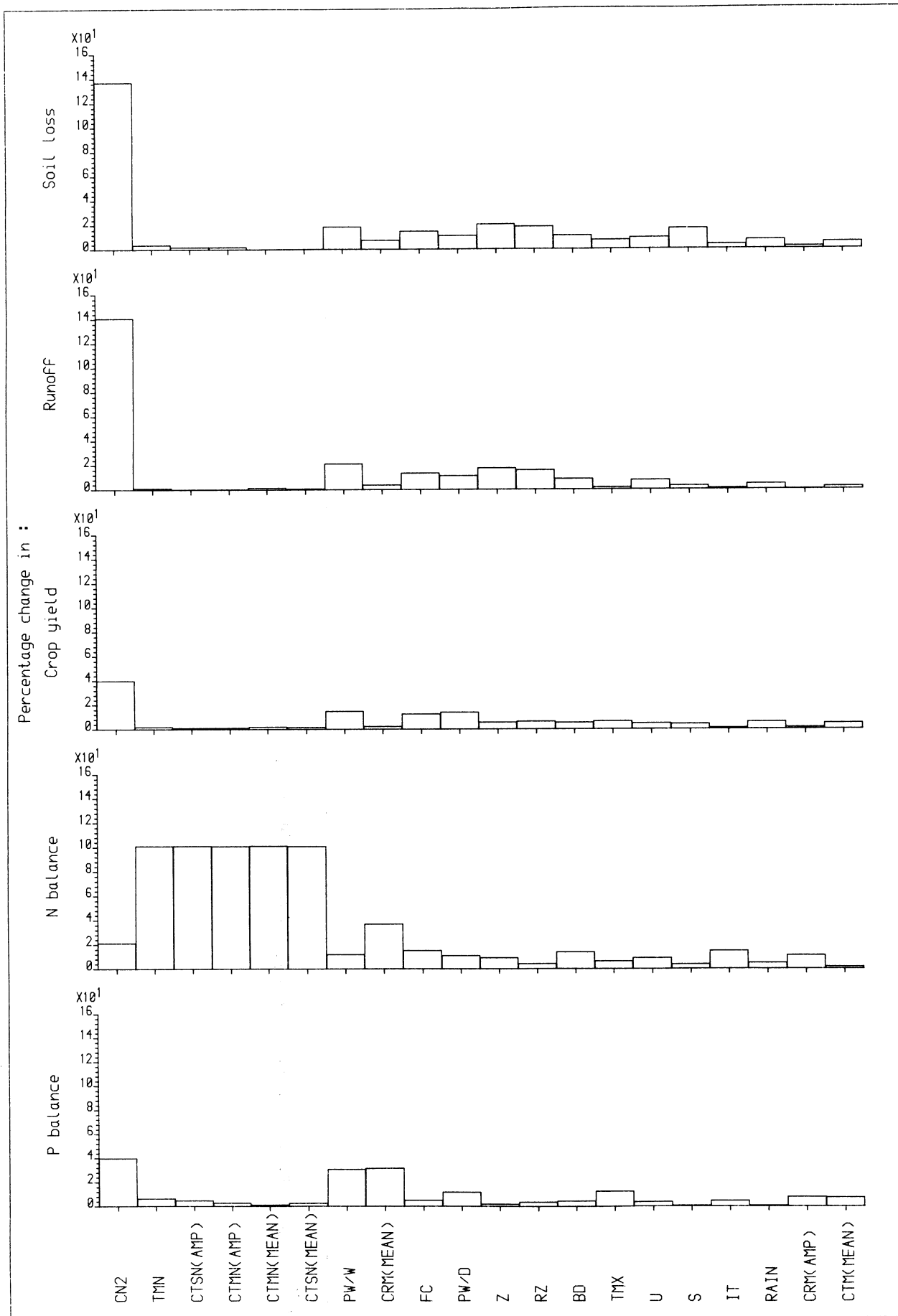

Figure 9.1
Percentage change in EPIC outputs for the Bell data set.

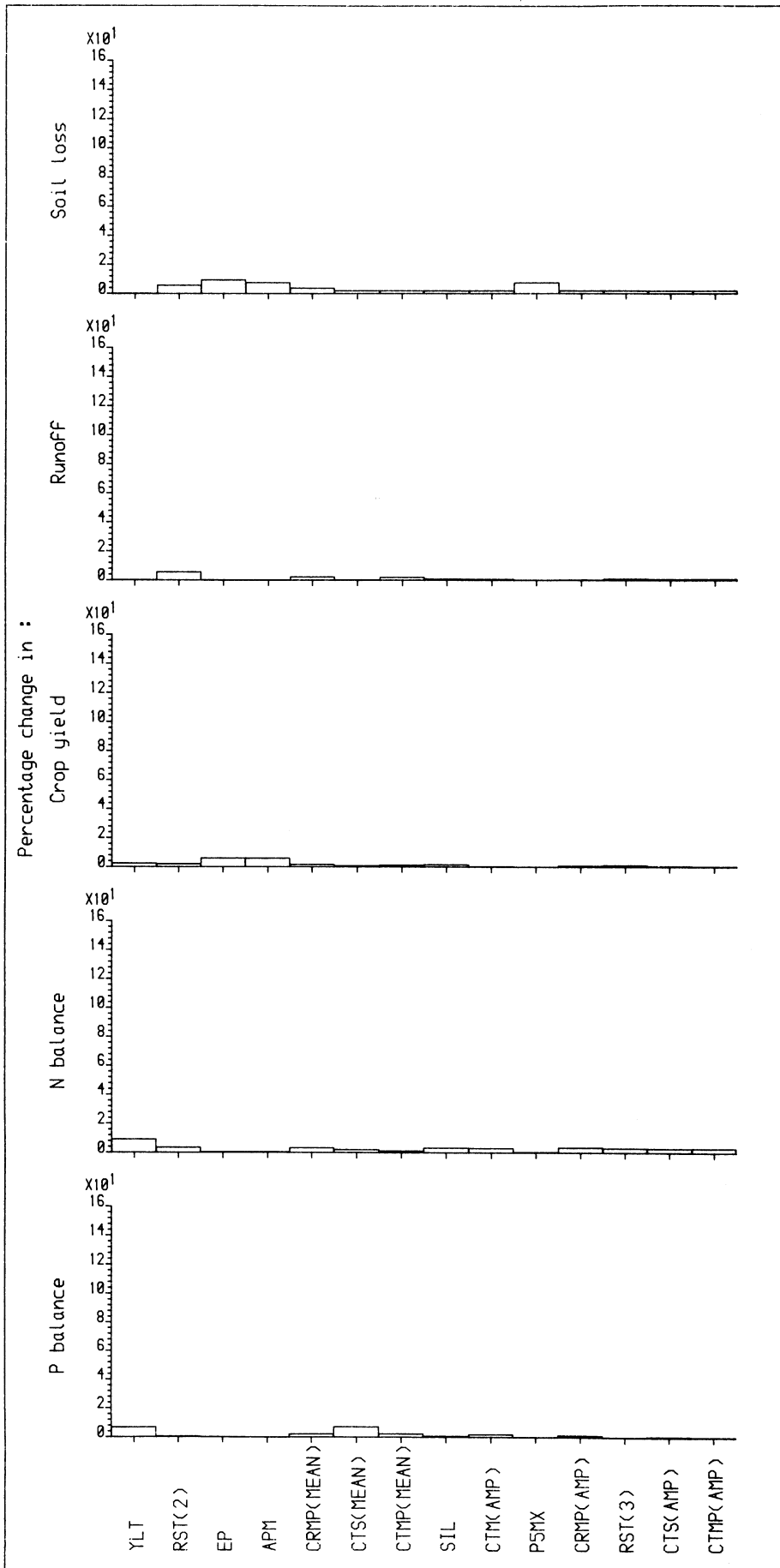

Figure 9.2
Percentage change in EPIC outputs for the Maricopa data set.

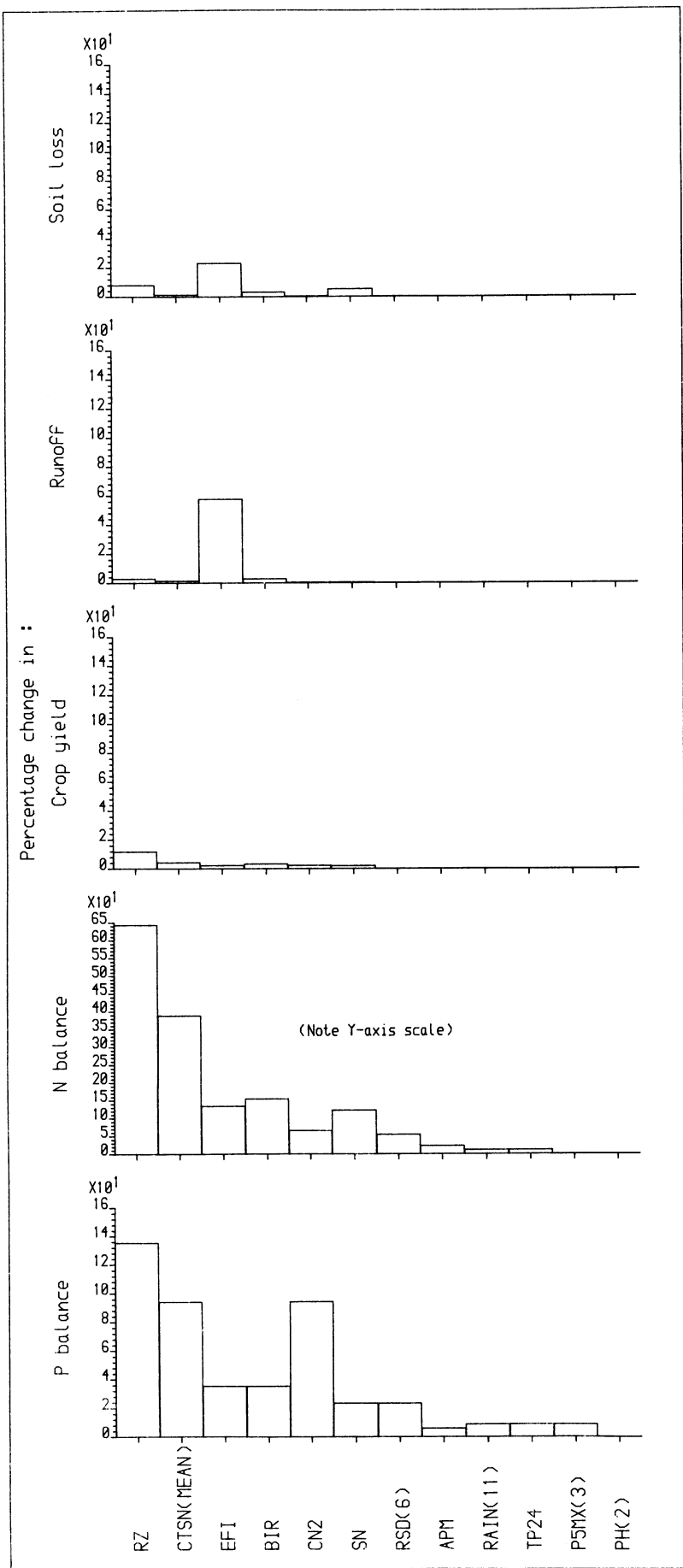

Figure 9.2--Continued.
Percentage change in EPIC outputs for the Maricopa data set.

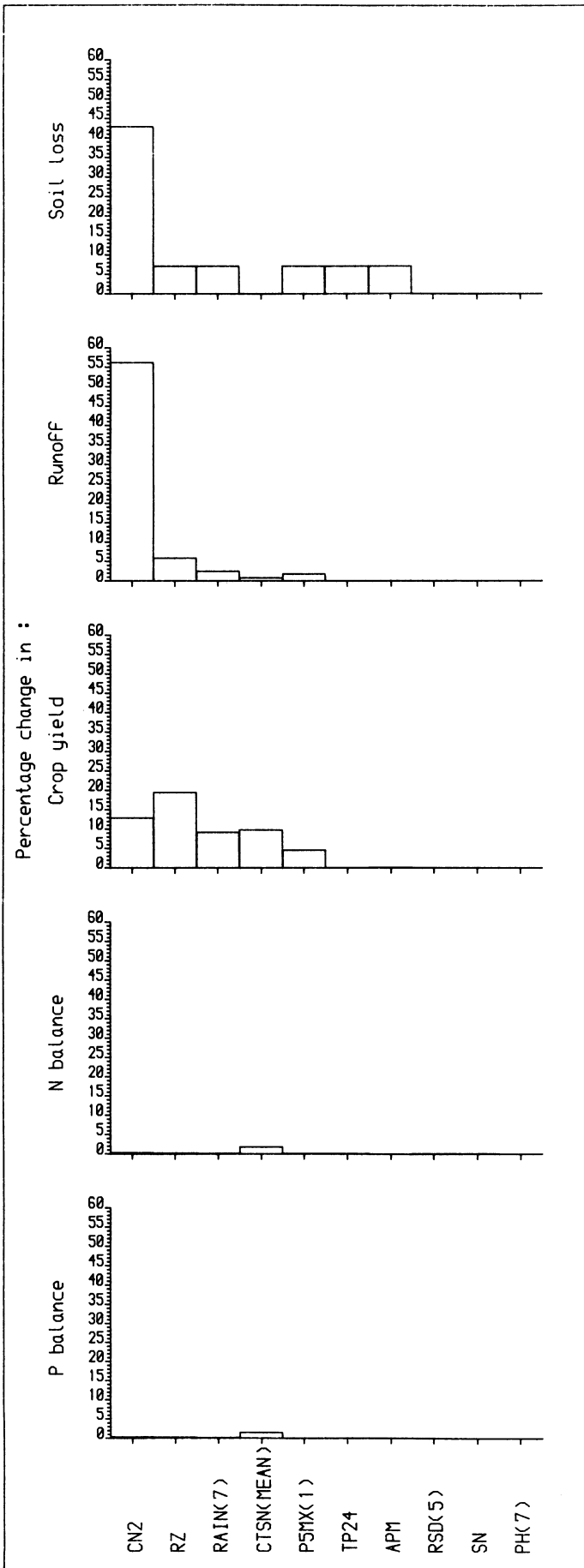

Figure 9.3
Percentage change in EPIC outputs for the Escambia data set.

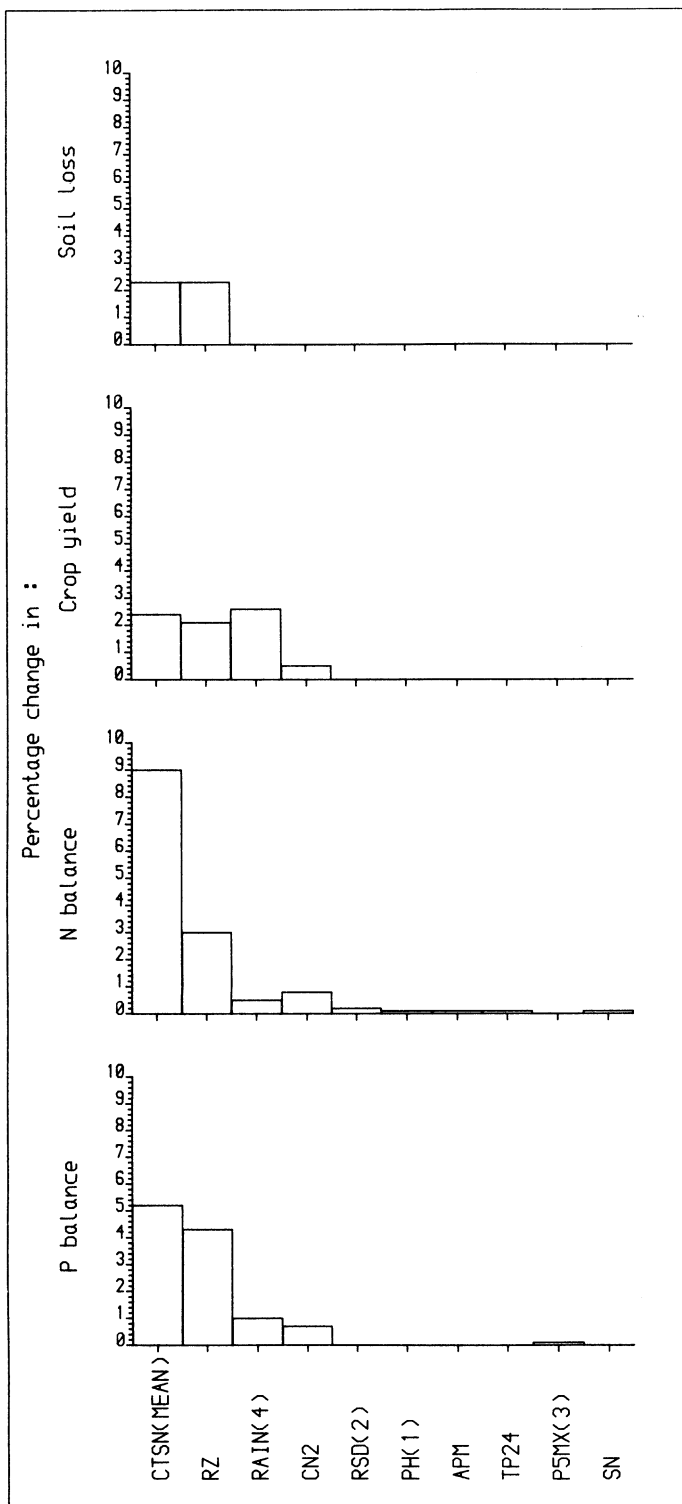

Figure 9.4
Percentage change in EPIC outputs for the Ellis data set.

Ellis data sets provide some evidence that certain EPIC inputs are consistently more sensitive than others, though the relative sensitivity of all inputs does indeed vary between data sets (cf. figures 9.1 - 9.4). The absolute sensitivity of inputs differs widely from data set to data set. Further test simulations using other EPIC data sets would probably throw more light on this issue of sensitivity.

A final, and very important, point is that in this analysis only one input was varied at any one time. The number of simulations required for all combinations of two or more inputs would be prohibitive. The methodology of this study has necessarily led to an oversimplification of the real-world situation, where perhaps many inputs in any EPIC data set may be inaccurate by unknown amounts. However, this analysis give at least a first approximation of the likely extent of variations produced in EPIC outputs by small inaccuracies in inputs.

GUIDANCE FOR EPIC USERS

The results of all simulations forming part of this study are summarized in table 9.2, with all tested EPIC inputs listed and placed into sensitivity categories. It is not possible, however, to consistently place inputs into sensitivity categories valid for every data set because sensitivities vary from one data set to another. Nonetheless, the table serves as a starting point for other EPIC users who might wish to assess the extent to which inevitable uncertainties in values specified for inputs may effect output values.

Some inputs have been tested in more than one data set so their sensitivity values reported in table 9.2 are means. The high sensitivity shown by BIR and EFI should be viewed with some caution, since these inputs could be tested only on the Maricopa data set, which exhibited an overall high sensitivity.

If time and computing resources permit, studies similar to ours should be made so that sensitive inputs may be identified. For any data set under consideration, the values of selected EPIC inputs (particularly those of doubtful accuracy or applicability) should be modified appropriately and the effect of the modification on relevant outputs noted.

A supplementary report, available from the Countryside Research Unit, contains further details of the amount and direction of changes produced by each EPIC input tested in this study.

Table 9.2
 EPIC inputs for all data sets placed into
 sensitivity categories

EPIC input data item	% variation caused in output ¹	EPIC input data item	% variation caused in output ¹
EFI	50.0	CTMP (MEAN)	
-----		SIL	
RZ		CTM (AMP)	
BIR		TP24	
CN2		CRMP (AMP)	1.0- 1.9
CTSN (MEAN)	20.0- 49.9	P5MX	
TMN		RST (3)	
CTSN (AMP)		CTS (AMP)	
CTMN (AMP)		CTMP (AMP)	
CTMN (MEAN)		-----	
-----		TD	
PW/W		TP5	
CRM (MEAN)		SALB	0.5- 0.9
FC	10.0- 19.9	WN	
PW/D		CBN	
Z		-----	
-----		DA	
BD		TP6	
SN		SL	
TMX	5.0- 9.9	RTN	
WT		SAN	
S		AP	
IT		CHS	
-----		ZMX	0.5
CRM (AMP)		CHL	
CTM (MEAN)		CAC	
RSD		WN03	
YLT	3.0- 4.9	PH	
RST (2)		CHN	
RAIN		BFT	
EP		RCN	

CRMP (MEAN)			
APM	2.0- 2.9		
CTS (MEAN)			

¹ Mean change for 5 outputs.

NOTATIONS

AP	=	Initial labile P concentration (kg/ha)
APM	=	Peak rate - USLE energy rainfall factor
BD	=	Bulk density (t/m ³)
BFT	=	N plant stress that triggers fertilizer N application
BIR	=	Value of water stress factor when irrigation begins
CAC	=	Calcium carbonate concentration (%)
CBN	=	Organic carbon saturation of soil layer (%)
CHL	=	Mainstem channel length (km)
CHN	=	Manning's N for channel (%)
CHS	=	Mainstem channel slope (%)
CN2	=	Runoff curve number for moisture condition 2
CRM	=	Mean Solar radiation on days with no rain (Ly)
CRMP	=	Mean Solar radiation on days with rain (Ly)
CTM	=	Mean Maximum temperature on days with no rain (°C)
CTMN	=	Mean Minimum temperature (°C)
CTMP	=	Mean Maximum temperature on days with rain (°C)
CTSN	=	Coefficient of variation in minimum temperature
CTS	=	Coefficient of variation for maximum temperature
DA	=	Drainage area (ha)
EFI	=	Irrigation runoff ratio
EP	=	Erosion control practice factor
FC	=	Water content of soil layer at 33 bars (mm/mm)
IT	=	Day of tillage operation
MT	=	Month of tillage operation
P5MX	=	Monthly maximum 0.5-h rainfall for period of record (mm)
PH	=	pH of soil layer
PW/D	=	Monthly probability of wet day after dry day
PW/W	=	Monthly probability of wet day after wet day
RAIN	=	Mean monthly precipitation (mm)
RCN	=	Mean concentration of N in rainfall (mg/L)
RSD	=	Crop residue content of soil layer (kg/ha)
RST(2)	=	Standard deviation of daily rainfall
RST(3)	=	Skew coefficient of daily rainfall
RTN	=	Number of years of cultivation before simulation starts
RZ	=	Maximum root zone depth (mm)
S	=	Slope steepness (m/m)
SALB	=	Soil albedo
SAN	=	Sand content of soil layer (%)
SIL	=	Silt content of soil layer (%)
SL	=	Slope length (m)
SN	=	Manning's N for surface flow
TDL	=	Tillage depth (mm)
TD	=	Daily mean maximum temperature for dry days (°C)
TMN	=	Observed monthly minimum temperature
TMX	=	Observed monthly maximum temperature
TP5	=	10yr frequency 0.5 h rainfall (mm)
TP6	=	10yr frequency 6.0 rainfall (mm)

TP24 = Number of years of record of maximum 0.5 h rain
U = Water content of soil layer at 15 kPa (mm/mm)
WN = Initial organic N concentration (kg/ha)
WT = Daily mean maximum temperature for wet days (°C)
WN03 = Initial NO₃ concentration (kg/ha)
YLT = Latitude (°)
Z = Depth from the surface to bottom of soil layer (mm)
ZMX = Maximum soil depth (mm)

ACKNOWLEDGMENTS

Thanks to John Boardman and Trevor Harris for many helpful comments and suggestions, and to Andrew Sharpley for coordinating the work done here with the USDA-ARS, EPIC development team.

10. EVALUATION OF EPIC USING A DRYLAND WHEAT-SORGHUM-FALLOW CROP ROTATION

J.L. Steiner, J.R. Williams, and O.R. Jones

ABSTRACT

The accuracy of EPIC in predictions involving dryland cropping was evaluated by comparing predicted data with corresponding actual data collected from 1958 to 1984 at Bushland, TX. Wheat (*Triticum aestivum* L.) and sorghum (*Sorghum bicolor* (L.) Moench) were grown on a Pullman clay loam (a fine, mixed, thermic Torrertic Paleustoll) in a rotation, with two crops harvested each 3 years. Each phase of the rotation was in place each calendar year.

Predicted and observed mean growing season evapotranspiration, annual runoff, crop yield, and growing season soil water depletion were not significantly different, though the soil water content was underpredicted by a mean of 20 mm in the profile. The performance of EPIC was generally satisfactory for simulating of the water balance over a long period, with means, standard errors of the mean, ranges, and probability distributions of evapotranspiration, runoff, and growing season soil water depletion being very similar for observed and predicted values. EPIC can be used to complement field experimentation in research programs in semiarid regions.

INTRODUCTION

Dryland research requires a long-term commitment of personnel and resources because crop production is extremely variable and many of the management alternatives offer small-- but important-- improvements in production that are difficult to measure with statistical significance. One of the objectives of dryland cropping research is to develop agronomic management practices which optimize production over time under variable climatic conditions. Because of the time required, only a few management options can be tested in long-term field experiments.

Analysis of soil-crop-climate interactions using a mechanistic simulation model can expand research programs by allowing the results of field experiments to be extrapolated across a regional range of soils, climates, and management practices. Williams (1985) and Williams and Renard (1985) showed that EPIC performed well in predicting crop yields and runoff in humid regions. However, the performance of the crop model and water balance subroutines under water-deficit conditions was not adequately tested in those validation tests. Data collected from a dryland wheat-sorghum-fallow experiment at Bushland, TX, over a 26-yr period includes soil water content, runoff, and crop yield. The objective of this study was to evaluate the model performance in predicting evapotranspiration (ET), runoff, the soil water balance, and crop yield with dryland cropping at the Bushland site.

DESCRIPTION OF THE VALIDATION TEST

The field data were collected from 1958 to 1984 from a wheat-sorghum-fallow (WSF) rotation which produced one wheat crop (*Triticum aestivum* L.) and one grain sorghum crop (*Sorghum bicolor* (L.) Moench) every 3 years. A generalized summary of the rotation and tillage operations is given in table 10.1. Part of the water-use and yield data (1958-1972) were summarized by Jones (1975).

Table 10.1
Cultural practices during the 4 phases of
a wheat-sorghum-fallow rotation, using stubble
mulch tillage at Bushland, TX, 1958-1984

Phase	Month ¹	Description of cultural practices
Wheat crop	1-9	Seeded hard red winter wheat at 30-35 kg/ha. Insects and weeds controlled by spraying as needed. Yield measured by hand or machine harvest. Soil moisture measured at planting and harvest by gravimetric sampling or neutron probe.
Fallow after wheat	10-20	Weed control by sweep tillage at 8-10 cm. Usually 2 to 4 operations were required to control volunteer wheat and weeds through summer and fall and 2 to 3 in spring.
Sorghum crop	21-25	Seeded a medium-maturity variety at 2.2 to 2.8 kg/ha. Usually 1 to 2 cultivation operations required for weed control. Insects sprayed as needed. Yield data by hand or machine harvest. Soil moisture measured at planting and harvest.
Fallow after sorghum	26-36	Weed control by sweep tillage at 8-10 cm. Usually 2 to 5 operations were required through spring and summer.

¹ Month of the 3-yr rotation, beginning with the seeding of winter wheat in the fall.

The field experiment was conducted at the USDA-ARS, Conservation and Production Research Laboratory at Bushland, TX, (35.2° N.; 102.1° W.; 1170 m elev.). Three graded terraces were constructed on a field having about 0.015 m/m slope. Hauser et al. (1962) gave additional details about the terrace design. The soil profile characteristics for the Pullman clay loam (a fine, mixed, thermic Torrertic Paleustoll) are summarized in table 10.2. The crop rotation was established so that each phase of the 3-yr rotation would be in place on one of the terraced plots each year.

Mean monthly temperature and precipitation for Bushland are summarized in figure 10.1. Deviations of monthly precipitation from the long-term monthly average over the 26-yr period (figure 10.2) were extremely variable and sometimes quite large, showing the need for long-term evaluation of agronomic practices. Rainfall data were collected at a weather station located about 1.5 km from the plots from 1958 to 1961 and from two gauges located at the runoff plots from 1962 to the present (1985).

Table 10.2
Description of Pullman clay loam, Bushland, TX, by layer

	Soil layer number								
	1	2	3	4	5	6	7	8	9
Lower boundary (m)	0.01	0.15	0.30	0.45	0.75	1.05	1.20	1.35	1.50
Upper limit H ₂ O (m ³ /m ³)	0.327	0.327	0.331	0.321	0.327	0.306	0.270	0.253	0.263
Lower limit H ₂ O (m ³ /m ³)	0.110	0.110	0.192	0.192	0.179	0.181	0.182	0.188	0.212
Saturated cond. (mm/h)	1.25	1.25	1.25	1.25	1.25	1.25	1.25	1.25	1.25
Bulk density (Mg/m ³)	1.40	1.40	1.53	1.49	1.61	1.63	1.46	1.40	1.42
Sand (%)	17.0	17.0	13.0	13.0	13.0	15.0	17.0	19.0	19.0
Clay (%)	30.0	30.0	48.0	48.0	48.0	48.0	44.0	44.0	44.0
pH	6.7	6.7	6.8	6.9	7.2	7.6	7.6	7.7	7.7
CaCO ₃ (%)	0.5	0.5	0.5	3.5	3.5	3.5	2.7	2.7	45.0
Labile P (%)	0.005	0.005	0.001	0.001	0.000	0.001	0.001	0.001	0.001
Active organic N (%)	0.053	0.053	0.016	0.012	0.011	0.010	0.010	0.007	0.004
Organic carbon (%)	1.03	1.03	0.65	0.60	0.48	0.38	0.28	0.20	0.20

Sources: Taylor et al. (1963), Unger and Pringle (1981), and J. L. Steiner (unpublished data).

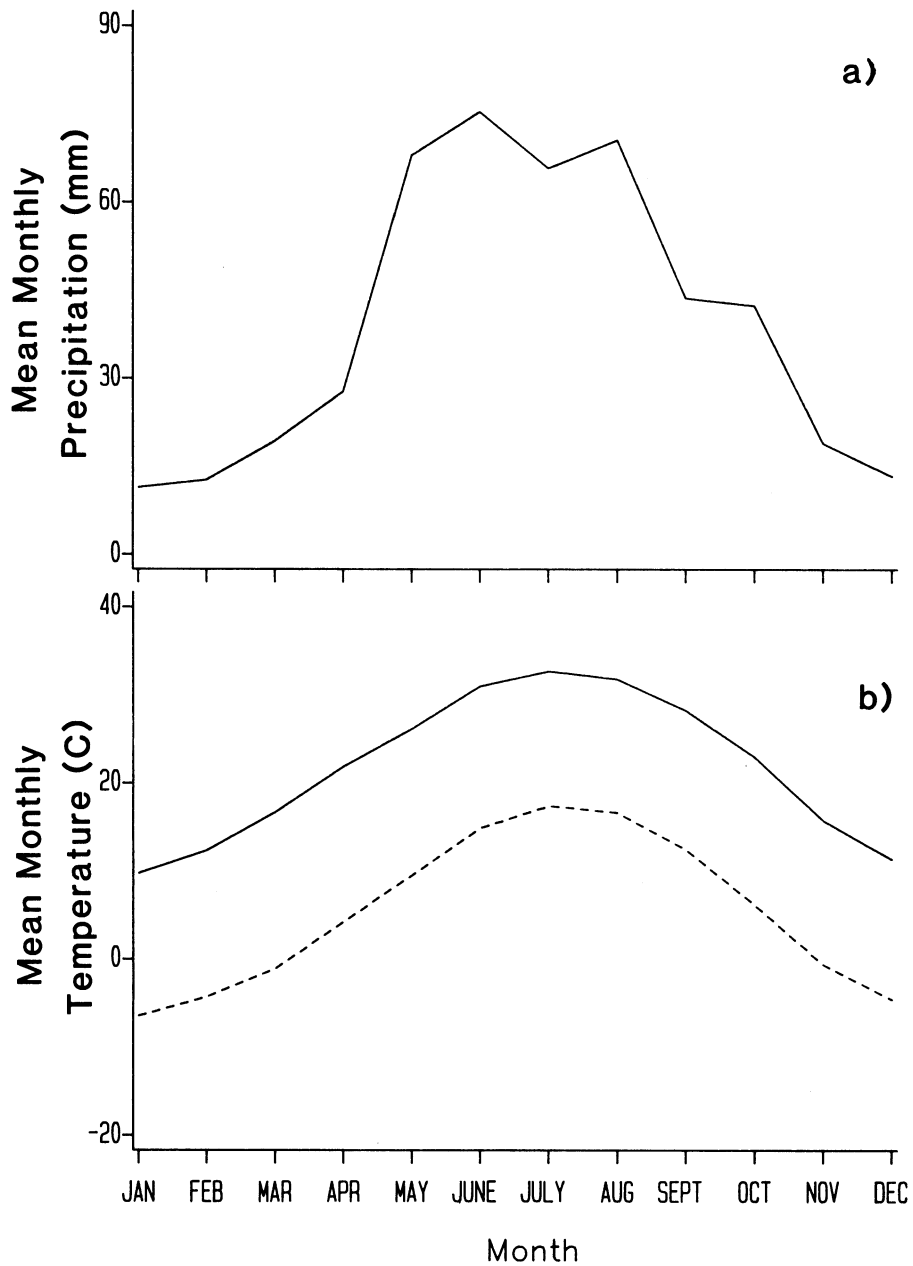

Figure 10.1
Summary of average monthly precipitation (a) and maximum and minimum temperature (b), Bushland, TX, 1958-1984.

Runoff data were obtained from each graded terrace watershed with 76-cm H flumes and summarized by Jones et al. (1985). Soil water content was measured to a depth of 1.8 m gravimetrically or with a neutron probe at planting and harvest of each crop. Drainage was assumed to be negligible. ET was calculated using the soil water balance method. Temperature and windrun were measured at the weather station for the entire period. Solar radiation was measured at the station from 1968 to the present, with data prior to 1968 collected at the Amarillo airport located about 50 km east of the Bushland weather station. Daily mean relative humidity was estimated using the climatic simulator in EPIC.

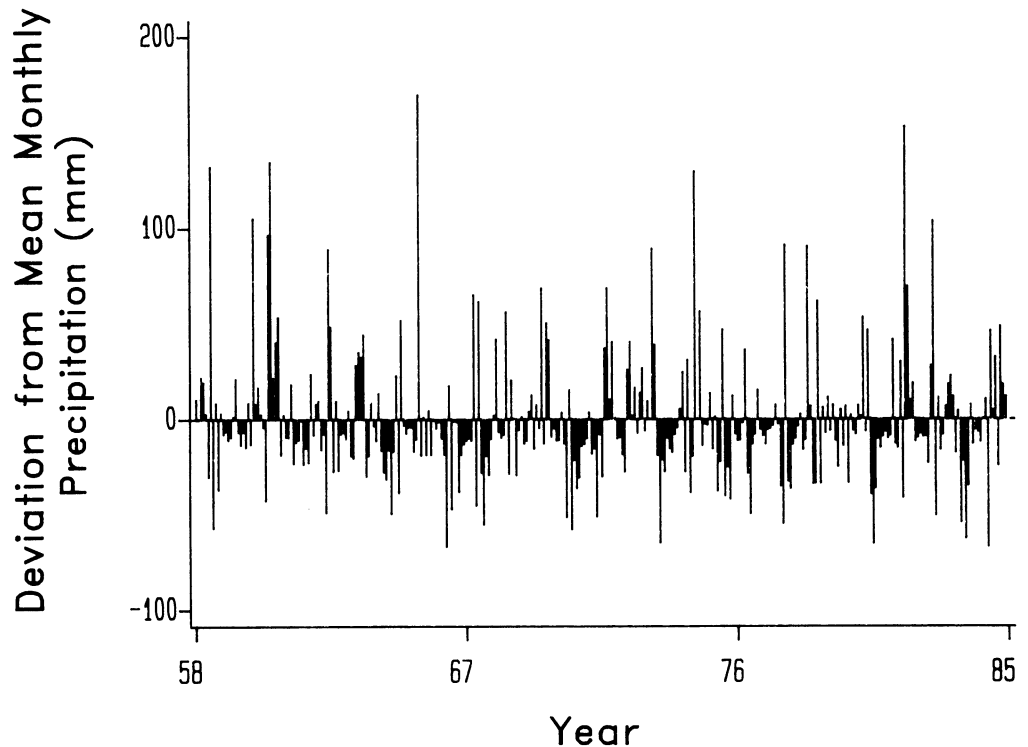

Figure 10.2
Deviation of monthly precipitation from long-term average,
Bushland, TX, 1958-1984.

Description of the model used is given in chapter 2 of this publication. The simulation runs reported in this section used the Penman (1948) model for calculating potential evapotranspiration as described by Doorenbos and Pruitt (1977). Potential evapotranspiration (E_o in mm) is calculated as

$$E_o = [S/(S + \gamma)R_n/L + \gamma/(\gamma + S)]f(u)(e_s - e_a) \quad [10.1]$$

where L is the latent heat of vaporization (MJ/kg), s is the slope of the saturation vapor pressure curve taken at the mean air temperature ($\text{kPa}/^\circ\text{C}$), γ is the psychrometric constant ($0.058 \text{ kPa}/^\circ\text{C}$, for Bushland) which was corrected for the mean barometric pressure at the elevation of the location (88.4 kPa), R_n is net radiation (MJ/m^2), $f(u)$ is a function of the mean daily windspeed, and $(e_s - e_a)$ is the vapor pressure deficit (kPa) at mean air temperature. Soil heat flux is assumed to be negligible on a 24-hour basis and is ignored in the energy balance. Potential evaporation is partitioned into potential soil evaporation (E_s) and plant transpiration (E_p) components using leaf area index (Ritchie 1972) as described in chapter 2.

MODEL PERFORMANCE AND DISCUSSION

The performance of EPIC in predicting soil water balance components is summarized in table 10.3. Paired t-tests were used to compare observed and predicted values for each year of growing season ET, total profile soil water content (SW) to 1.83 m at planting and harvest, growing season soil water depletion (DEPL), and annual runoff (RO). Except for soil water content, the mean difference between observed and predicted values was not statistically different from zero. In addition, the standard errors and ranges of observed and simulated data were similar for all of the components examined. Predicted SW was consistently less than the observed value, but the predicted mean contribution of stored soil water to growing season ET was 73 mm, compared to 75 mm observed over 51 crop years.

Table 10.3
Observed and predicted means (S.E.), paired t-tests, and ranges of water balance components in the wheat-sorghum-fallow rotation for 26 crop years, 1958-1984

	Growing season ET (mm)	Soil water content (mm)	Soil water depletion (mm)	Annual runoff (mm)
Observed mean	308 (11)	459 (5)	75 (8)	34 (5)
Predicted mean	304 (10)	436 (4)	73 (6)	40 (5)
Difference	-4 (8)	-23 (3)	2 (6)	6 (4)
t	0.55 n.s.	7.01**	0.50 n.s.	1.92 n.s.
Observed range	157 to 509	348 to 574	-79 to 163	0 to 173
Predicted range	136 to 462	360 to 529	-24 to 136	1 to 211

** , n.s. Paired t-test is significant at P >.01 or not significant, respectively. Significant t-test indicates rejection of null hypothesis that difference of observed and predicted means is zero.

Comparisons of observed vs. predicted values of ET, SW, DEPL, and RO are shown in figures 10.3-10.6. The points are generally distributed about the 1:1 line, but the data are variable. The model does not allow utilization of the full soil water storage capacity, as shown in figure 10.4. Predicted values of SW almost never reached the upper limit at planting nor the lower limit at harvest, though the observed values often did. This indicates a problem in the soil water extraction subroutine that must be further evaluated. The slopes of the regression lines fitted to these data were less than 1.0 (0.65, 0.65, 0.54, and 0.82, for ET, SW, DEPL, and RO, respectively), indicating a tendency for the model to underpredict at the high end and to overpredict at the low end of the range of values. Fitting a restricted regression line which fixed the intercept at 0.0 resulted in slopes closer to 1.0 (0.97, 0.95, 0.83, and 0.95 for ET, SW, DEPL, and RO, respectively), but the restriction was significant in all cases.

When the observed and predicted values of ET were ranked independently of one another and plotted as probability curves, the field and simulation data sets produced similar lines (figure 10.7). Line AC in figure 10.7a shows that for wheat the probability is 50% that growing-season ET will exceed 340 and 315 mm in field and simulation experiments, respectively. As another example, line DF in figure 10.7b shows that for sorghum, the probability is 80% that growing-season ET will exceed 225 and 260 mm in field and simulation experiments, respectively. Ranked values of the water balance components showed less variability than the graphs of paired observed and simulated data. Many simulation models are designed to determine the probability with which a given response or event will occur rather than to predict a specific yield in a specific year; and the performance of EPIC is promising for probabilistic types of analyses.

Runoff events were separated according to the phase of the WSF rotation as shown in figure 10.8. EPIC predicted the distribution of runoff events well according to examinations made in this way. Runoff during the crop growing seasons and during fallow after sorghum (figures 10.8 a, c, and d) was generally low, and the observed and predicted probability curves were practically indistinguishable. EPIC overpredicted runoff during the fallow after the wheat period due to slight overprediction during the moderate runoff events (figure 10.8b), but, again, the predicted and observed probability curves were very similar.

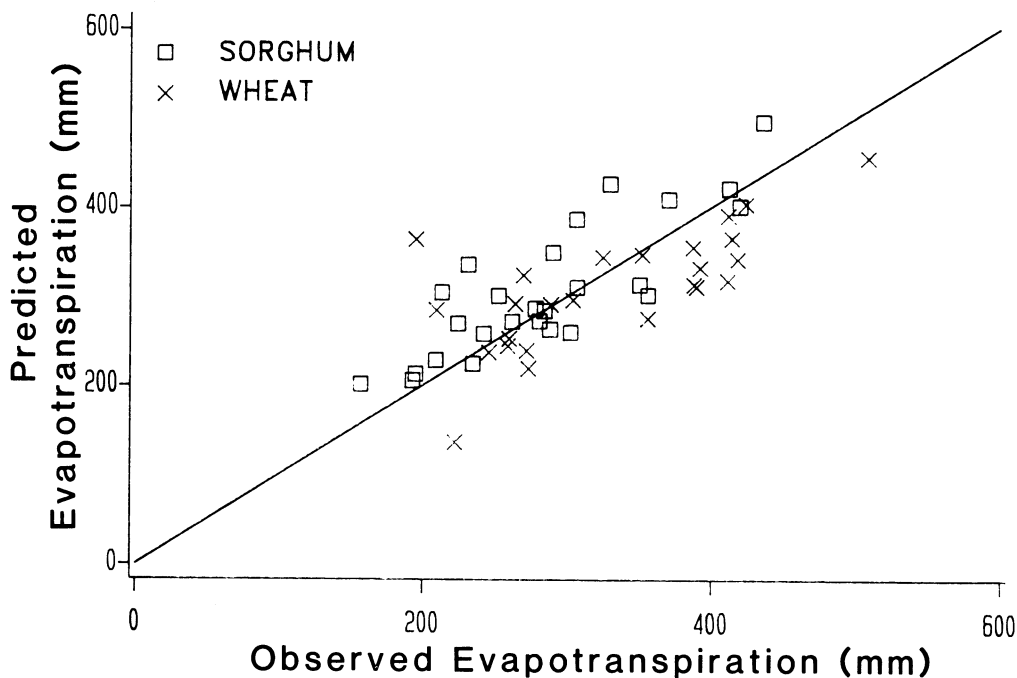

Figure 10.3
 Observed (E_{To}) and predicted (E_{Tp}) growing season
 evapotranspiration ($E_{Tp} = 102 + 0.65 E_{To}$, $R^2 = 0.63$).

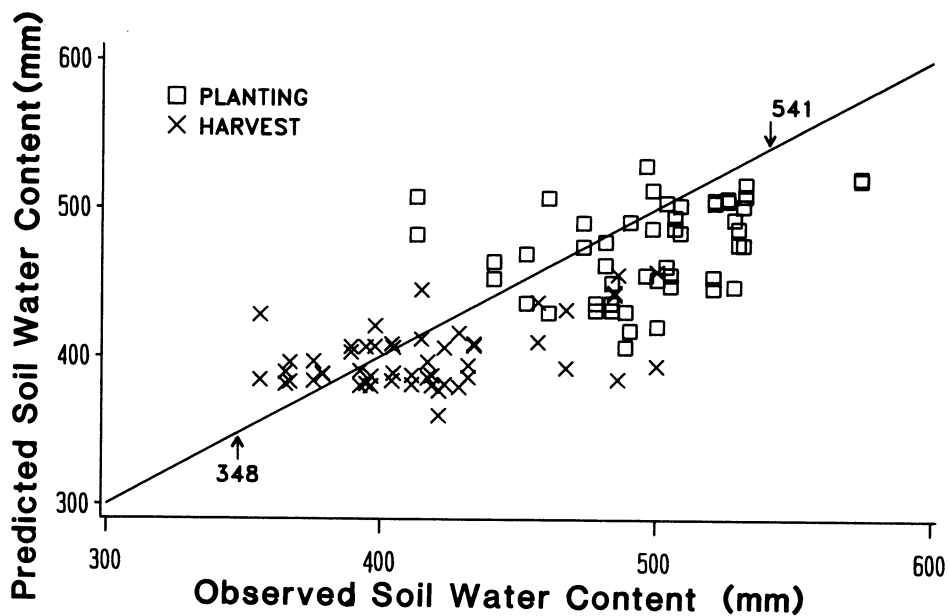

Figure 10.4
 Observed (SW_o) and predicted (SW_p) soil water content at
 planting and harvest. ($SW_p = 136 + 0.65 SW_o$, $R^2 = 0.63$).
 Input values of upper and lower limits of available water
 are shown by arrows.

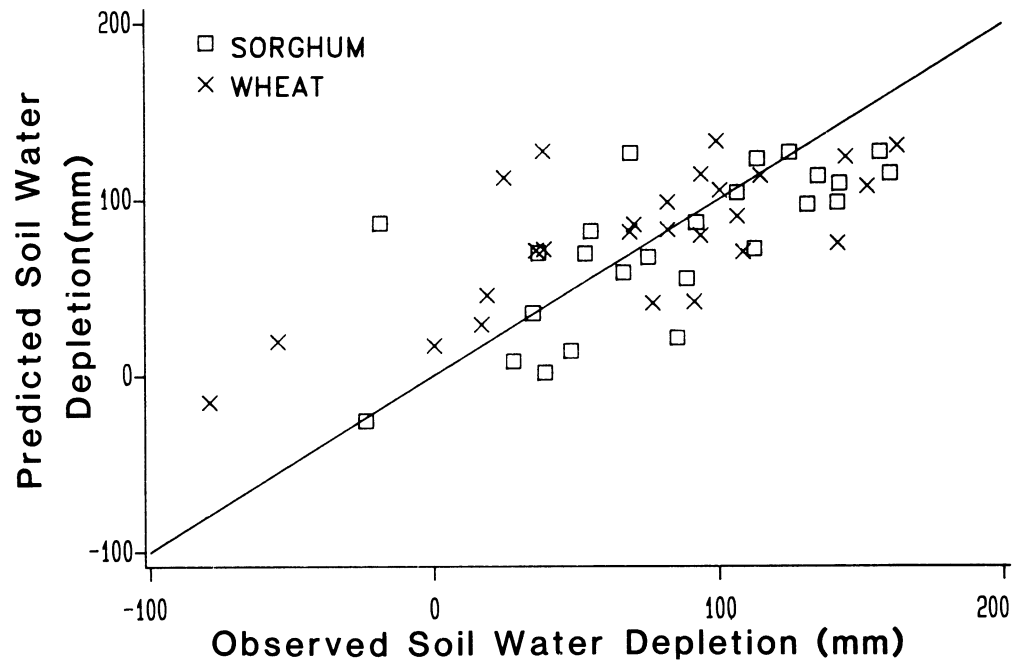

Figure 10.5
 Observed (DEPLo) and predicted (DEPLp) soil water depletion during the growing season. ($DEPLp = 32 + 0.54 DEPLo$, $R^2 = 0.49$).

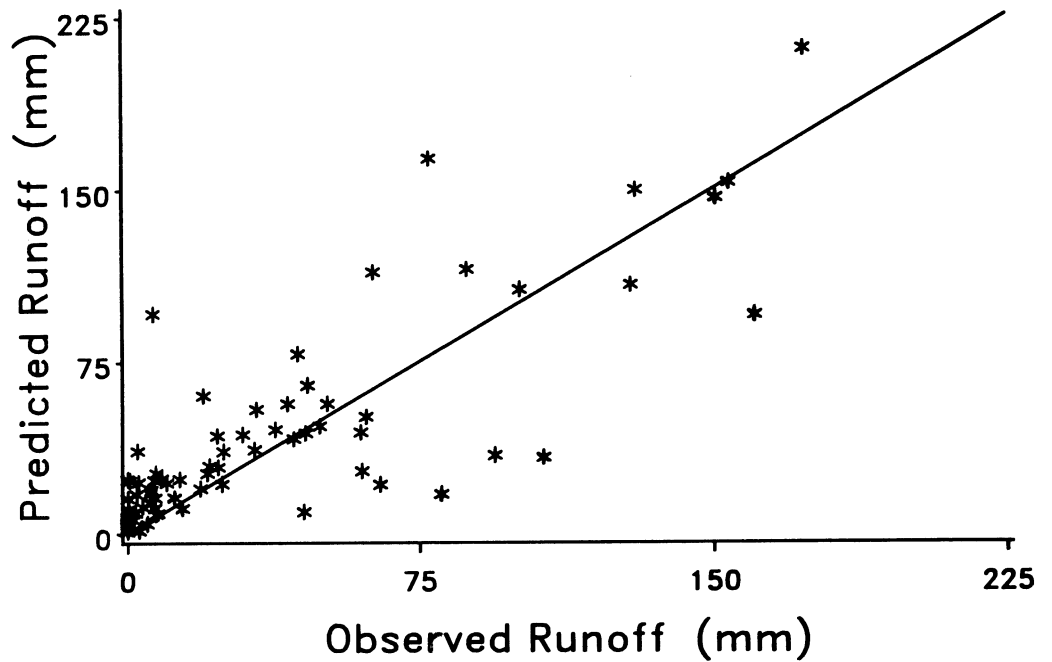

Figure 10.6
 Observed (ROo) and predicted (ROp) annual runoff. ($ROp = 12 + 0.82 ROo$, $R^2 = 0.67$).

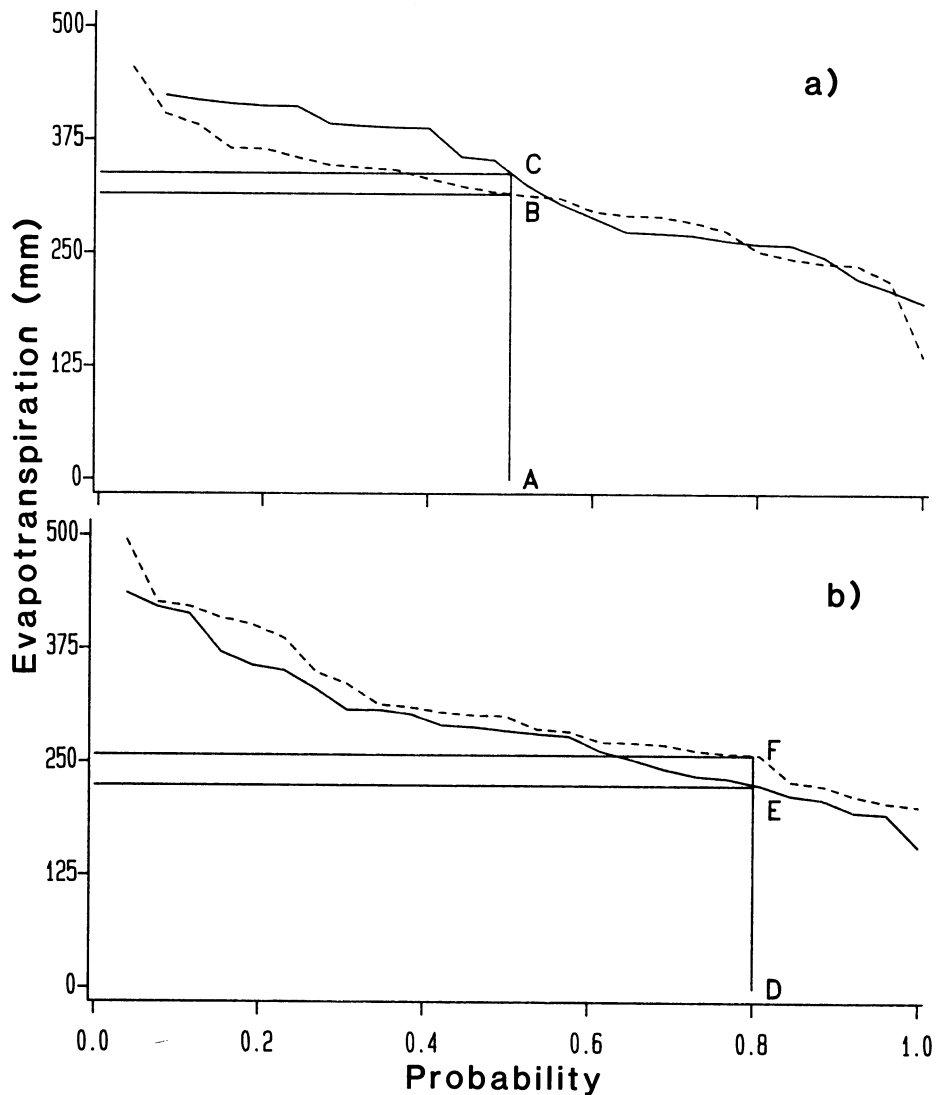

Figure 10.7
Probability curves of observed (—) and predicted (---) evapotranspiration during a) the wheat growing season and b) the sorghum growing season.

Yield prediction was more problematic. The predicted average grain yields of 1.7 and 3.7 Mg/ha for wheat and sorghum, respectively, are much higher than 1.1 and 2.1 Mg/ha which were measured on the plots (table 10.4). EPIC predicts the potential yield for a given set of climatic and agronomic conditions so that year-to-year variability in yield at Bushland is predicted primarily as a function of water stress. Field experiments to which the simulated experiment was compared suffered other yield-reducing factors, such as hail during the growing season, insects, weed competition, and early frost. However, when the

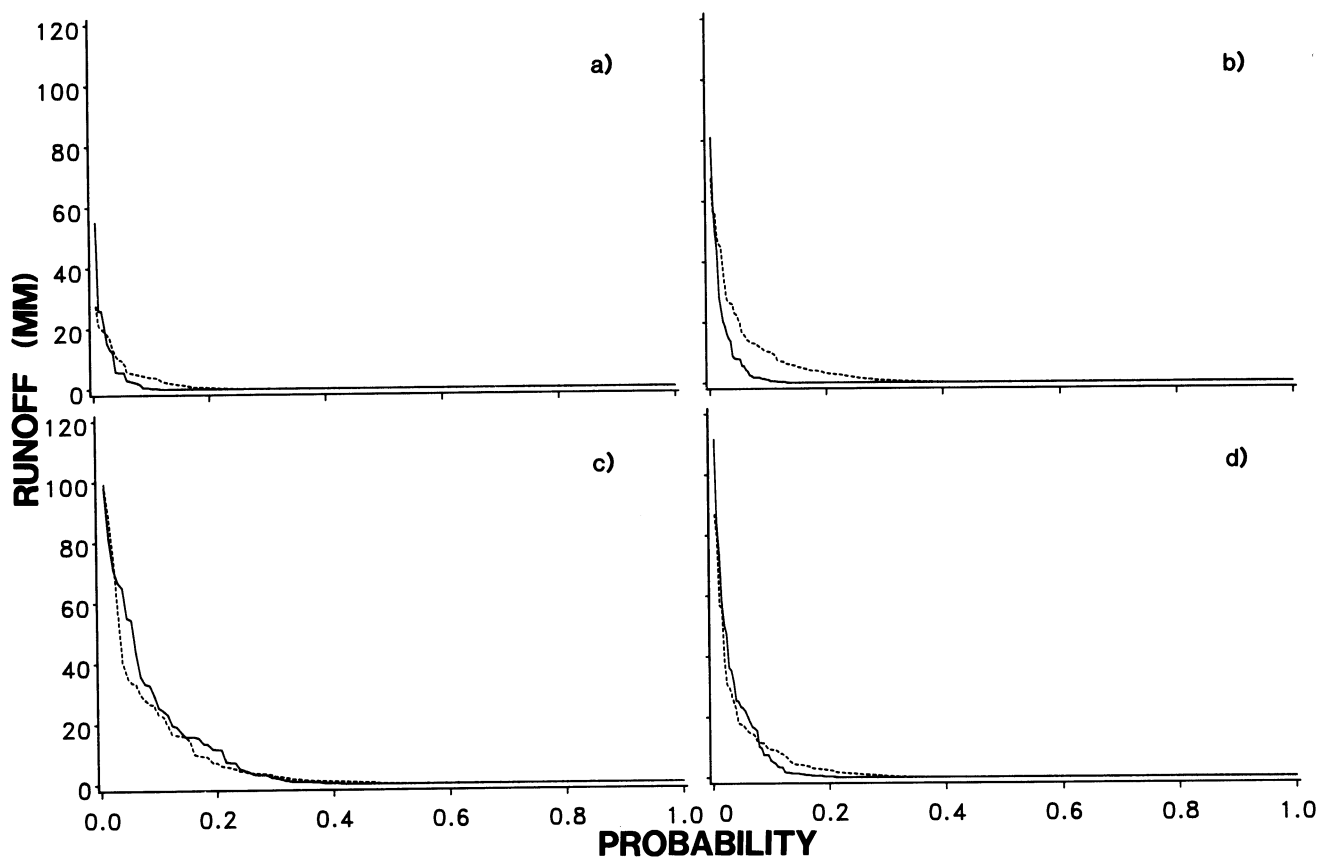

Figure 10.8
 Probability curves of observed (—) and predicted (---) monthly runoff during a) the wheat growing season, b) fallow after wheat, c) the sorghum growing season, and d) fallow after sorghum.

yield data were screened, excluding years when possible yield-limiting factors other than climate were mentioned in the field books, the yields were still overpredicted by over 50% for sorghum and 15% for wheat.

To evaluate the potential dry matter production in EPIC, we simulated wheat and sorghum yields with automatic irrigation and fertilization triggered when the fields were about to suffer stress. The predicted average yields of 7.2 and 13.1 Mg/ha for wheat and sorghum, respectively, were about 20% to 30% higher than yields obtained in well-watered, fertilized plots at Bushland. Howell et al. (1984) reported that irrigated winter wheat produced 2.3 g of above-ground dry matter per megajoule of intercepted photosynthesis activating radiation (IPAR). Steiner (1986) found that grain sorghum produced 2.2 g/MJ at Bushland,

Table. 10.4
 Observed and predicted means (S.E.) and paired
 t-tests of wheat and sorghum yields in a dryland
 rotation

	Wheat Yield		Sorghum Yield	
	Unscreened ¹	Screened ¹	Unscreened ¹	Screened ¹
	----- Mg/ha -----			
Observed	1.1 (0.1)	1.3 (0.1)	2.1 (0.2)	2.3 (0.3)
High Factor ²				
Predicted	1.7 (0.1)	1.5 (0.1)	3.7 (0.2)	3.6 (0.4)
Difference	0.6 (0.1)*	0.2 (0.1)n.s.	1.6 (0.2)**	1.3 (0.4)**
Low Factor ²				
Predicted	1.4 (0.1)	1.3 (0.1)	2.7 (0.2)	2.7 (0.3)
Difference	0.3 (0.1)*	0.0 (0.1)n.s.	0.6 (0.2)**	0.4 (0.3)n.s.

¹ Unscreened data includes data for all years of the simulation period (n = 25 for wheat, n = 26 for sorghum). Screened data (n = 15 for wheat and n = 13 for sorghum) excludes the years when yield-limiting factors other than water stress were mentioned in the field notes (i.e. hail, insects, weeds, early frost).

² High conversion factors are 3.0 and 3.5 g dry matter/MJ of IPAR (intercepted photosynthetically active radiation for wheat and sorghum respectively, as used by Williams and Renard (1985) in humid region tests. Low conversion factors are 2.5 g dry matter/MJ of IPAR for both crops.

** , * , n.s. Paired t-test is significant at P 0.05 or 0.01 or is not significant, respectively (H₀: Difference = 0.0).

based on early season growth. The default values in the crop tables of EPIC for the energy-to-dry-matter conversion constant (3.5 and 3.0 g/MJ for sorghum and wheat, respectively) appear too high for crop simulations at Bushland.

The conversion efficiency may be lower for semiarid regions because of higher respiration rates under the higher temperature regime. In addition, the assumptions about potential partitioning of dry matter to roots may not describe rooting under semiarid or water-limited climates. The performance of the model in predicting yield was considerably improved by using lower energy conversion factors (table 10.4). With screening of the data, the paired t-test showed that the difference between simulated and measured yields was not significantly different from zero. The water balance calculations were not affected by the energy conversion factors. In 51 crop years, no water balance component (i.e., growing season ET, soil moisture at harvest, annual runoff) was changed more than 2 mm by reducing the energy conversion factor. In most cases, the data were virtually indistinguishable.

The simple model of dry matter partitioning predicted a harvest index (grain dry matter per total above-ground dry matter) of about 0.48 and 0.38 for sorghum and wheat, respectively. Crop yield estimates were relatively insensitive to increases in either the stress coefficient or the soil moisture level at which water uptake by roots falls below the potential uptake (data not shown).

CONCLUSIONS

The performance of EPIC in simulating the water balance of a wheat-sorghum-fallow rotation under semiarid conditions was generally satisfactory. Because the model is able to predict the water balance components in a semiarid region, it has potential for use in dryland agricultural research. Particularly encouraging was its ability to simultaneously predict reasonable values for evapotranspiration, runoff, and soil water depletion over a long period. Although the initial yield predictions were too high, changing the conversion constant for IPAR to dry matter in the crop table resulted in a reasonable distribution of predicted yield over the 26-year period.

There are many applications for which EPIC would be a useful model. By assigning dollar values to agronomic inputs and crop prices, the profitability of a management system can be evaluated. Identification of alternative crops which might be

suiting to the region could reduce the vulnerability of producers to low prices in grain crops. Using EPIC simulations, the potential yield production of new crops and risk of crop failure could be estimated under various agronomic management regimes before field research was initiated. Sowing date, long vs. short season varieties, and other agronomic regimes can be compared on a probabilistic basis to determine whether a given agronomic practice offers a potential yield benefit over a long period of time.

The use of simulation models can strengthen research in dryland cropping systems by allowing a broader interpretation of field experiments. Results can be extrapolated over longer durations or to different soil, climate, and management regimes. An annual rainfall gradient of about 0.6 mm/km in the east-west direction exists in the Southern High Plains. A strong temperature gradient (particularly first and last frost dates) exists in the northwest-southeast direction. Therefore, the results from a given research location may or may not be applicable on a regional basis. Evaluation of a promising management program through the use of simulation analysis may help define the region of applicability of research results. EPIC performed well in simulating the water balance of a dryland wheat-sorghum-fallow cropping rotation and provides a versatile tool for probabilistic cropping system analysis.

REFERENCES

- Doorenbos, J., and W.O. Pruitt. 1977. Guidelines for predicting crop water requirements. FAO Irrigation and Drainage Paper 24 (revised). Food and Agriculture Organization of the United Nations, Rome, p. 144.
- Hauser, V.L., C.E. Van Doren, and J.S. Robins. 1962. A comparison of level and graded terraces in the Southern High Plains. *Trans. Am. Soc. Agric. Eng.* 5:75-77.
- Howell, T.A., D.A. Dusek, J.T. Musick, and J.L. Steiner. 1984. Light interception by tall and short winter wheat genotypes under four soil water regimes. *Agron. Abstr.*, p. 13.
- Jones, O.R. 1975. Yields and water-use efficiencies of dryland winter wheat and grain sorghum production systems in the Southern High Plains. *Soil Sci. Soc. Am. Proc.* 39:98-103.
- Jones, O.R., H.V. Eck, S.J. Smith, and others. 1985. Runoff, soil and nutrient losses from rangeland and dry-farmed cropland in the Southern High Plains. *J. Soil Water Conserv.* 40:161-164.

- Penman, H.L. 1948. Natural evaporation from open, bare soil and grass. Proc. R. Soc., London, Ser. A 193:120-145.
- Ritchie, J.T. 1972. Model for predicting evaporation from a row crop with incomplete cover. Water Resour. Res. 8:1204-1213.
- Steiner, J.L. 1986. Dryland grain sorghum water use, light interception, and growth response to planting geometry. Agron. J. 78:720-726.
- Taylor, H.M., C.E. Van Doren, C.L. Godfrey, and J.R. Coover. 1963. Soils of the Southwestern Great Plains Field Station. Texas Agric. Exp. Sta. MP-669, 14 pp.
- Unger, P.W., and F.B. Pringle. 1981. Pullman soils: Distribution, importance, variability, and management. Texas Agric. Exp. Sta. B-1372, 23 pp.
- Williams, J.R. 1985. The physical components of the EPIC model. In S.A. El-Swaify, W.C. Moldenhauer, and A. Lo, eds., Soil Erosion and Conservation, Soil Conservation Society of America, Ankeny, IA. pp. 272-284.
- Williams, J.R., and K.G. Renard. 1985. Assessments of soil erosion and crop productivity with process models (EPIC). In: R.F. Follett and B.A. Stewart, eds., Soil Erosion and Crop Productivity, American Society of Agronomy, Madison, WI. pp. 67-103.

11. EVALUATION OF EPIC USING A SAGEBRUSH RANGE SITE

K.R. Cooley, D.C. Robertson, E.P. Springer,
J.R. Williams, and C.L. Hanson

ABSTRACT

EPIC was tested on a sagebrush range site in southwestern Idaho. Comparisons of model-simulated and observed forage yield, runoff, and soil water, along with comparisons of erosion and evapotranspiration as estimated by EPIC and by other models or methods, were used for calibration purposes. When the input parameters were adjusted so that mean model-simulated forage yield approached mean observed forage yield, the simulated and observed hydrologic state variables also approached each other, although the dynamics for individual years did not necessarily match. Best results were obtained for simulation involving a harvest on July 1st, with fertilizer addition to represent recycling of the nutrients removed by the harvest. This study indicates that the EPIC model can be adapted for range use and that prediction accuracy will increase if the calibration is based on longer-term forage and meteorological records.

INTRODUCTION

EPIC was developed for and has been tested mainly on cultivated lands, but it is intended to be used for all major land resource areas within the United States. Since rangeland (including forested grazing land) represents about 50% of the land area in the United States and produces annual renewable forage resources without high expenditures for expensive energy supplies, it is also extremely important that EPIC be evaluated for use under range conditions. In addition, the upward costs of producing grain-fed cattle and the trend of consumers toward leaner meats (Cook et al. 1984) increase the importance of selecting management plans for maintaining or increasing forage production on rangelands.

The objective of this study was to evaluate the EPIC model on a sagebrush range site in the Northwestern United States.

STUDY AREA AND METHODS

The site selected for evaluating EPIC is part of the Reynolds Creek Experimental Watershed located in southwestern Idaho and is representative of sagebrush ecosystems found in the Northwestern United States (Robins et al. 1965). The site called Lower Sheep Creek was chosen because of data availability. It is designated as a shallow-clay-pan (305-406 mm, 12-16 inch) range site. Average annual precipitation is 354 mm, and precipitation is in the form of snow during

November-March (50% of annual total). The site generally has an intermittent snow cover in winter, and runoff is usually produced by snowmelt sometimes associated with frozen soils. A summary of site characteristics is presented in table 11.1

The EPIC model was calibrated for the Lower Sheep Creek range site by using actual temperature, precipitation, radiation, and forage yield data for the 1976-81 period. Calibration consisted of adjusting plant growth parameters until mean model-simulated yield matched mean observed forage yield of the ungrazed site, which consisted of herbaceous and shrubby vegetation as determined by the double-sampling weight-estimate method. Hydrologic state variables (soil water, runoff, and erosion) were also compared to observed values.

The present version of the plant growth model in EPIC does not contain a rangeland option; therefore, the pasture grasses option was used in this study. The default values in the pasture grasses option were changed to reflect the specific

Table 11.1
Watershed characteristics at Lower Sheep Creek
study site

Characteristic	Description
Size	13.36 ha
Elevation	1650 m
Average Slope	16%
Aspect	NW
Soils	
Subgroup	Calcic Argixerolls.
Family	Loamy Skeletal Mixed.
Series	Searla Gravelly Loam.
Geologic material	Basalt
Vegetation	Sandberg Bluegrass, low sagebrush.
% vegetation cover ¹	24%
Average precipitation	354 mm
SCS hydrologic soil group ²	B

¹ Basal cover of live vegetation.

² U.S. Department of Agriculture, Soil Conservation Service (1972).

vegetation and climatic conditions found at Lower Sheep Creek. Three different scenarios with differing assumptions concerning harvesting and fertilization schemes were used to calculate the annual yields.

The first scenario consisted of a harvest typical for alfalfa i.e., forage cut off 12 mm above ground. The harvest was simulated to occur on July 1 each year, with no fertilization. This scenario was meant to simulate what might happen if livestock grazed the range and removed some of the vegetation. However, under range conditions, livestock tend to recycle the nitrogen, and only a very small portion (probably about 1%) is estimated to leave the area via the livestock (Wight 1976).

The second scenario consisted of the same harvest conditions and date as scenario 1 but included an application of 10 kg/ha of nitrogen (N) on April 1 each year. This application represented an attempt to correct for nitrogen loss resulting from livestock grazing. A fertilization rate of 10 kg/ha was chosen to maintain but not increase production. To increase production, an addition of 30-50 kg/ha is usually required (Wight 1976).

The third scenario represented a nongrazed condition in that no harvest or fertilization was simulated, and vegetation was allowed to grow, die, and decompose on the site. Since data for the nongrazed condition were from an enclosure, the third scenario probably best represented the actual study site. However, since the model does not create a forage yield value under the conditions of scenario 3, it was necessary to develop a relationship between yield and dry matter produced so that the calculated and measured forage yields could be compared. A relationship was therefore developed between dry matter and yield obtained in scenarios 1 and 2. The regression relationship developed showed a very good fit ($r = 0.99$), and dry matter values for scenario 3 were merely multiplied by the coefficient obtained to produce yield values for comparison.

Calibration was assumed to be completed when mean simulated forage yields for the test period essentially matched mean measured yields. Means were used because of the known variations possible in measured forage yield data.

Another check on the accuracy of the EPIC model consisted of comparing water balance components with measured values or with values obtained from simulations that had been carried out with the Ekalaka Rangeland Hydrology and Yield Model (ERHYM) (Wight and Neff 1983) and the Soil-Plant-Air-Water Model (SPA-W) (Saxton et al. 1974) for the same site (Cooley and Robertson 1984). EPIC-simulated values for annual runoff and for soil water stored in the total soil profile at the end of each year were

compared with measured values. Values for percolation and total evapotranspiration simulated by EPIC were compared to corresponding values simulated by the ERHYM and SPAW models. The relationship between plant transpiration, soil evaporation, and total evapotranspiration was also examined since the three models use different methods of obtaining these values.

RESULTS AND DISCUSSION

Considerable year-to-year variability was noted between the simulated and observed forage yield and, to some extent, between simulated and measured water balance data. The differences could have been due to factors such as invalid model relationship and measurement errors. Yearly forage yields are especially subject to question because of spatial variation and the possible use of different sampling techniques and sampling personnel. Therefore, study period means were used for comparison during calibration. Also, as previously noted, the plant growth model in EPIC does not presently include a range option. The pasture grasses option used in this study may not have accounted for the mixed herbaceous and shrubby plants that were included in the forage measurements. The annual yields (near peak standing crop) measured near the end of June and the EPIC-simulated yields as of July 1 for the three different scenarios are presented in table 11.2, along with means for the periods.

Although the dynamics of the simulated and observed yields were generally similar (table 11.2), some differences were evident. For example, the model-predicted forage yields for 1978 were below average, while the measured values were greater than the 8-year average. The 1978 precipitation was also greater than the average. The standard deviation in the ungrazed measured values for the 1976-79 period, was about 2.5 times (480 vs. 190) the standard deviations estimated from the simulated values. This points to the need for longer-term records for model calibration when possible. Such short periods prevent any comparison of the trend of observed and simulated values.

Based on length of record means (8 yr for measured, 6 yr for simulated) or the means for the 4 years of common record, the yields for scenario 2 appear to best match observed yields. Scenario 3 yields match almost as well, but scenario 1 yields are considerably lower, probably due to the removal of nutrients during harvest. Since the 4 years of common record provide the best comparison, scenarios 2 and 3 would appear to produce essentially the same results.

Table 11.2
 Measured and simulated forage yields at Lower
 Sheep Creek (kg/ha air dry weight) and annual
 precipitation (mm)

Year	Measured		EPIC- simulated			Annual precipi- tation
	Grazed	Ungrazed	Grazed		Ungrazed	
			(1) ¹	(2) ²		
1971	917	954				
1972	492	380				
1973	---	---				
1974	726	671				
1975	769	771				
1976	433	607	784	920	802	262
1977	392	155	533	688	779	292
1978	834	1320	392	579	374	343
1979	804	588	313	477	506	263
1980			133	326	375	384
1981			776	1040	1138	360
Period mean	671	681	489	672	662	317
Standard deviation	201	353	260	270	300	52
4 Year mean (1976-1979)	616	668	506	666	615	290
Standard deviation	236	483	207	190	209	38

¹ Scenario 1 - Harvest typical for alfalfa. Simulated to occur on July 1 each year, with no fertilization.

² Scenario 2 - Harvest typical for alfalfa. Simulated to occur on July 1 each year, but nitrogen fertilizer applied at 10 kg/ha on April 1 each year.

³ Scenario 3 - No harvest or fertilization. Yield computed from dry matter available on June 30 each year.

Measured and simulated amounts of soil water in the total soil profile at the end of each year are presented in table 11.3. Again, scenario 2 provided the best match to observed data. Scenario 1 overpredicted soil water most years (less vegetation to remove water from the soil profile), and scenario 3

Table 11.3
 EPIC-simulated soil water (mm) in soil profile at the end of each year and annual runoff (mm) compared to measured values at Lower Sheep Creek

Year	Soil Water			Runoff				
	EPIC			EPIC				
	Meas.	Grazed	Ungrazed	Meas.	Grazed	Ungrazed		
	(1) ¹	(2) ²	(3) ³	(1) ¹	(2) ²	(3) ³		
1976	320	334	325	274	14	13	13	13
1977	356	378	350	295	0	2	2	1
1978	345	378	353	306	4	12	9	4
1979	341	373	346	292	9	7	5	9
1980	327	383	351	294	0	2	2	0
1981	420	407	382	326	0	3	4	0
Mean	352	376	351	298	5	7	6	5
Standard dev.	36	24	18	17				

¹ Scenario 1 - Harvest typical for alfalfa. Simulated to occur on July 1 each year, with no fertilization.

² Scenario 2 - Harvest typical for alfalfa. Simulated to occur on July 1 each year, but nitrogen fertilizer applied at 10 kg/ha on April 1 each year.

³ Scenario 3 - No harvest or fertilization. Yield computed from dry matter available on June 30 each year.

underpredicted soil water all 6 years (with no harvest, the vegetation appears to be stimulated and thus removes more water). Simulated and observed values for runoff, which is normally a minor component of the water balance at this site, are also presented in table 11.3. Scenario 3 runoff values are essentially identical to measured values all 6 years. Scenario 2 produced about the same runoff as measured runoff, on the average, but the dynamics are not matched as well. Scenario 1 runoff values are slightly higher than measured, and the dynamics are similar to those of scenario 2. Considering all three measured components (yield, soil water, runoff), the order of decreasing match with observed values is scenario 2, scenario 3, and scenario 1 values.

Although field measurements of percolation and evapotranspiration (ET) were not available, previous testing of soil water models (SPAW and ERHYM) at the Lower Sheep Creek site (Cooley and Robertson 1984) provided estimates for comparison of these components between models. Since all of the models account for all of the hydrologic components properly, the differences in one component, e.g., soil water, are balanced by differences in another component, e.g., percolation. As footnoted in table 11.4, percolation as calculated by SPAW and ERHYM was zero. But all three EPIC scenarios resulted in percolation values greater than observed or simulated values of runoff (c.f., tables 11.3 and 11.4). The greater percolation simulated in EPIC, seemed to be accounted for mainly by the runoff term in ERHYM (average 37.3 mm/yr for ERHYM vs. 6 mm/yr for EPIC, scenario 2) and in the ET term in SPAW (average 289 mm/yr in SPAW vs. 268 mm/yr in EPIC, scenario 2). SPAW predicted the highest average ET while ERHYM produced the lowest (table 11.4), and all EPIC scenarios produced values in between.

The ET values produced by the three different models compare well, considering that all use different methods of determining potential and actual ET. ERHYM uses the Jensen-Haise (1963) equation to determine potential ET, and a crop coefficient plus water availability relationships to determine actual soil evaporation and plant transpiration. SPAW uses pan evaporation to determine actual transpiration and evaporation values (Saxton et al. 1974). EPIC uses the Ritchie leaf area index method (Ritchie 1972) to divide potential ET (derived from a temperature and radiation controlled combination equation) into potential plant transpiration and soil evaporation factors. These factors are then modified by available soil water relationships to provide actual transpiration and evaporation.

Since the three models produce simulated values of both the plant and soil components of total ET and since the magnitudes of these parameters have long been of interest to hydrologists and others, but are rarely, if ever, measured, results from all

Table 11.4
 Evapotranspiration and percolation simulated
 by ERHYM, SPAW, and EPIC Models¹

Year	Evapotranspiration, mm/yr					Percolation ² , mm/yr		
	ERHYM	SPAW	EPIC			EPIC		
			Grazed	Ungrazed		Grazed	Ungrazed	
			(1) ³	(2) ⁴	(3) ⁵	(1) ³	(2) ⁴	(3) ⁵
1976	285	--	283	292	343	24	24	24
1977	237	246	213	236	240	26	23	23
1978	267	327	277	285	293	58	50	37
1979	256	255	231	234	254	33	33	23
1980	288	355	322	333	352	50	44	27
1981	225	261	247	254	267	56	43	29
6- Year mean	260	--	262	272	292	41	36	27
5- Year mean	255	289	258	268	281	--	--	--

¹ ERHYM and SPAW data from Cooley and Robertson (1984).

² ERHYM and SPAW yield zero percolation.

³ Scenario 1 - Harvest typical for alfalfa. Simulated to occur on July 1 each year, with no fertilization.

⁴ Scenario 2 - Harvest typical for alfalfa. Simulated to occur on July 1 each year, but nitrogen fertilizer applied at 10 kg/ha on April 1 each year.

⁵ Scenario 3 - No harvest or fertilization. Yield computed from dry matter available on June 30 each year.

three models are presented in tables 11.4 and 11.5. Even though ERHYM and SPAW produced the lowest and highest mean ET, respectively, the ratios between EP and ET (plant transpiration and total evapotranspiration) for the two models were essentially identical. These ratios thus showed that the plant component (transpiration) accounted for about 38% of the total (5-yr mean). The EPIC model, with total ET, simulated plant

Table 11.5
Ratio of plant evapotranspiration (EP)
to total evapotranspiration (ET)

	EP / ET ¹				
	ERHYM	SPAW	EPIC(1) ² EPIC(2) ³		EPIC(3) ⁴
			Grazed	Ungrazed	
1976	0.38	--	0.27	0.30	0.41
1977	0.33	0.32	0.12	0.22	0.24
1978	0.40	0.39	0.11	0.14	0.19
1979	0.38	0.28	0.10	0.12	0.20
1980	0.38	0.38	0.07	0.11	0.18
1981	0.40	0.48	0.18	0.21	0.26
6-Year mean	0.38	--	0.14	0.18	0.25
5-Year mean	0.38	0.37	0.11	0.16	0.21

¹ ERHYM and SPAW data from Cooley and Robertson (1984).

² Scenario 1 - Harvest typical for alfalfa. Simulated to occur on July 1 each year, with no fertilization.

³ Scenario 2 - Harvest typical for alfalfa. Simulated to occur on July 1 each year, but nitrogen fertilizer applied at 10 kg/ha on April 1 each year.

⁴ Scenario 3 - No harvest or fertilization. Yield computed from dry matter available on June 30 each year.

components of only 14% to 25% of the total (6-yr mean). These differences could have been due to the different approaches used in the models or to differences in the input parameters. It is difficult to keep all inputs consistent, since ERHYM uses a percent plant cover and growth curve, SPAW uses a phenology curve, and EPIC uses the number of plants per unit area and leaf area index. The relationship between all of these factors is not well known, nor are all of the measurements or curves available. Therefore, estimates were made based on available data, previous studies, and experience. At least the models indicate that in this case, the plant component accounts for about one-third of the total ET and soil evaporation for about two-thirds.

Although measured annual soil loss values were not available for Lower Sheep Creek, measurements from Upper Sheep Creek and experience suggest that erosion from Lower Sheep Creek would average less than 1.00 kg/ha/yr (Johnson and Smith 1978). EPIC-predicted erosion averaged 0.66, 0.61, and 0.58 hg/ha for scenarios 1, 2, and 3, respectively. Thus simulated erosion and estimated erosion are essentially the same.

CONCLUSIONS

Limited data availability prevented a long-term calibration of the model. Best results were obtained when the simulation involved harvest with N fertilizer added to represent the recycling of N removed by the harvest. A no-harvest scenario produced very good results but required a relationship between dry matter and yield that had to be developed empirically by using data outputs from the other scenarios.

The advantage of a model like EPIC is its capability to simulate long-term scenarios by using the stochastic climate generator. In terms of range management this capability is of particular importance, since economics often dictate limited data and immediate decisions. This study has provided insight into how well the EPIC model can be used to represent observed data over a short time. The next logical step is extension to longer periods.

Not all range management questions regarding system productivity can be answered by using EPIC, i.e., grazing systems cannot be easily simulated at present. The primary use of the model would be to predict the long-term impacts of annual forage removal by livestock or the influence of range fertilization. Without a range option (at the present only grasses are considered), the effects of certain actions such as shrub invasion cannot be considered. Still, in its present form, EPIC can be of use to range managers.

REFERENCES

- Cook, C. W., D. A. Cramer, and L. Rittenhouse. 1984. Acceptable block beef from steers grazing range and crop forages. *J. Range Manage.* 37:122-126.
- Cooley, K.R., and D.C. Robertson. 1984. Evaluating soil water models on western rangeland. *J. Range Manage.* 37:529-534.
- Jensen, M.E., and H.R. Haise. 1963. Estimating evapotranspiration from solar radiation. *Proc. Am. Soc. Civ. Eng. J. Irrig. Drain. Div.* 89:15-41.
- Johnson, C.W., and J.P. Smith. 1978. Sediment characteristics and transport from northwest rangeland watersheds. *Trans. Am. Soc. Agric. Eng.* 21:1157-62, 1168.
- Ritchie, J.T. 1972. A model for predicting evaporation from a row crop with incomplete cover. *Water Resour. Res.* 8:1204-1213.
- Robins, J.S., L.L. Kelly, and W.R. Hamon. 1965. Reynolds Creek in southwest Idaho: An outdoor hydrologic laboratory. *Water Resour. Res.* 1:407-413.
- Saxton, K.E., H.P. Johnson, and R.H. Shaw. 1974. Modeling evapotranspiration and soil moisture. *Trans. Am. Soc. Agriv. Eng.* 17:673-677.
- Wight, J.R. 1976. Range fertilization in the northern Great Plains. *J. Range Manage.* 29:180-185.
- Wight, J.R., and E.L. Neff. 1983. Soil-vegetation-hydrology studies: Vol. II. A users manual for ERHYM: The Ekalaka Rangeland Hydrology and Field Model. U.S. Dep. Agric. Res. Serv., Agricultural Research Results. ARR-W-29, January. Oakland, CA. 93 p.

12. EVALUATION OF EPIC NUTRIENT PROJECTIONS USING SOIL PROFILES FOR VIRGIN AND CULTIVATED LANDS OF THE SAME SOIL SERIES

S.J. Smith, A.N. Sharpley, and A.D. Nicks

ABSTRACT

An example is given, using Houston Black clay, to illustrate how available soil profile data for virgin and cultivated lands of the same soil may be used to assess EPIC predictions for cultivated practices over time. Total N, organic P, organic C, and pH predictions by EPIC compared favorably with the measured field values. Additional calibration may be required for predictions of certain other P forms.

INTRODUCTION

Since EPIC will provide projections of soil fertility and productivity following up to 50 years of specific management practices, some means is needed for evaluating how realistic the projections are. The ideal, direct approach is to impose the specified management practices for the given period on the pertinent soil series and then take actual field measurements.

Such an approach, however, is impractical from both an economic and time standpoint. An alternative, indirect approach is to compare the EPIC nutrient projections for virgin land to be placed under cultivation with field-measured nutrient contents of a paired cultivated land under management similar to that input in the model. The purpose of the work reported in this chapter was to make such a comparison. The soil used was Houston Black clay, which dominates the Texas Blackland prairie land resource area. This soil belongs to the Vertisol soil order and has a taxonomic classification of Udic Pellusterts. Vertisols present numerous management problems due to their high shrink/swell characteristics. Consequently, Houston Black clay can be expected to present a fairly rigorous test for model nutrient projections.

SOIL MANAGEMENT

The available management history of the field measured-Houston Black clay is as follows. The soil profile for the cultivated land was based on triplicate samples collected in 15-cm depth increments to 90-cm in April 1972, from land with a 1%-2% slope in the small plot studies area (Smith et al. 1954) of the Blackland Experiment Station. Complete, detailed records were not obtainable, but according to best available records, the land was broken out of virgin prairie around the turn of the century and was farmed to area crops for about 60 years (Smith and Young 1975). Prior to sampling, the land was in continuous grain sorghum for 15 years, receiving 29 kg P and 37 kg K per ha per yr. Annual N application rate was 67 kg/ha during 1958-64 and 101 kg/ha during 1964-72. The soil profile for the virgin land was based concurrent samples taken from a nearby

unfertilized native grassland. Additional information about the virgin soil and the aforementioned cultivated analog are given in a recent publication (Sharpley et al. 1983).

At present the nutrient component of EPIC considers only two major plant nutrients, N and P; and these nutrients are accounted for by soil contribution, residue decomposition, and fertilizer application. The nutrients are removed by growing plants, immobilized by decomposing crop residues, and leached by soil water drainage. Inputs required are soil organic C, exchangeable cation, and particle size. EPIC was run for a 3-year rotation of cotton - grain sorghum - wheat on a 22% slope for a 50-year period. Respective fertilizer N applications of 52, 160, and 30 kg N per hectare per year and 32 and 0 kg P per hectare per year were made for each crop.

EVALUATION OF NUTRIENT PROJECTIONS

Predictions of soil N, P, C, and pH status from the EPIC run (June 1982 version) and the field-measured data are compared in table 12.1. Results are reported as the amount and percentage change in nutrient status of the surface soil (0-15 cm depth), subsoil (15-90 cm depth), and the soil profile (0-90 cm depth). Reasonable agreement of the changes in total N, organic P, and organic C following cultivation was obtained for all three soil-depth categories. In contrast, agreement was not as good for the content changes of total, inorganic, and available P. The pH, included here as a general measure of overall base nutrient status, also exhibited good agreement (see chapter 8 for additional information on pH changes associated with EPIC projections). No estimates of nitrate-N were made because this N form, being susceptible to leaching/denitrification, often varies in amount depending on the soil water content at the time of sampling.

The EPIC model run using Houston Black clay illustrates, in a general way, how available soil profile data for virgin and cultivated lands of the same soil may be used in assessing EPIC predictions for cultural practices over time. The total N, organic P, organic C, and pH components of the EPIC run compared favorably with measured field values, whereas the other P forms compared less favorably. Thus, for this soil and the cultural practice applied to it, the P subroutine in the model (June 1982 version) may require additional calibration and/or modification. It should be noted, however, that some discrepancy would be expected because the model conditions and the actual conditions were not exactly the same. Utilization of additional soil profile data for virgin and cultivated lands of the same soil (Sharpley et al. 1983) in simulations by EPIC is anticipated to provide a similar, general guide for evaluating model projections of nutrient cycling in soils.

Table 12.1

Measured changes in the nutrient content of Houston Black soil following cultivation for 60 years and cultivation-induced changes predicted for the same but virgin soil by the EPIC model over a 50-year period

Change in nutrient content												
0-15 cm soil depth				15-19 cm soil depth				0-90 cm profile				
Measured		EPIC		Measured		EPIC		Measured		EPIC		
Amount	Percent ¹	Amount	Percent	Amount	Percent	Amount	Percent	Amount	Percent	Amount	Percent	
kg/ha	%	kg/ha	%	kg/ha	%	kg/ha	%	kg/ha	%	kg/ha	%	
Total N	1140	-49	1063	-40	693	-17	2795	-29	1838	-29	2870	-29
Total P	57	9	283	-18	25	1	846	-15	46	2	858	-15
Inorg.P	236	71	147	-9	6	0.4	233	-5	242	13	232	-5
Org.P	179	-65	179	-55	116	-24	615	-51	295	-38	626	-51
Avail.P	0.3	-30	46.6	-83	0.4	16	166.2	-86	0.7	20	168	-80
Org.C ²	1.04	-43	1.23	-41	1.64	-28	1.08	-23	268	-33	1.79	-40
pH	No Change		No Change		No Change		No Change		No Change		No Change	

¹ Represented as a percent of that in the virgin soil.

² Units for organic C are Mg/ha.

REFERENCES

- Sharpley, A.N., S.J. Smith, and L.W. Reed. 1983. Selected properties of paired virgin and cultivated soils from major resource areas. Okla. State Univ. Exp. Stn. Bull. T-159.
- Smith, S.J., and L.B. Young. 1975. Distribution of nitrogen forms in virgin and cultivated soils. Soil Sci. 120:354-368.
- Smith, R.G., R.C. Henderson, and O.J. Tippet. 1954. Summary of soil and water conservation research from the Blackland Experiment Station, Temple, Texas, 1943-53. Texas A&M Agric. Exp. Stn. Bull. 781.

13. DEMONSTRATION AND VALIDATION OF CROP GRAIN YIELD SIMULATION BY EPIC

J.R. Kiniry, D.A. Spanel, J.R. Williams, and C.A. Jones

ABSTRACT

This chapter summarizes an extensive evaluation of grain yield prediction by the crop model in EPIC. The model predicted reasonable trends of decreasing corn yield with decreasing soil depth for three regions differing in average rainfall. Predictions were reasonably accurate for grain yield of corn, rice, sunflower, soybeans, and barley in a wide range of environments. The model also simulated corn yield response to irrigation for three arid locations and appeared to be an effective tool for irrigation scheduling.

INTRODUCTION

The crop model in EPIC requires a number of crop-specific inputs. Once these input parameters were set for a crop species, they were not adjusted for individual data sets or locations. Values for these parameters were at least partially determined through trial and error in runs using some of the data sets in this chapter. With this in mind, the work reported in this chapter was designed more to demonstrate the capabilities of EPIC in simulating crop yield response to environment than to independently test the model's ability to predict yield. Duration of plant growth is dependent on the input value for date of maturity or an optional value for heat units from planting to maturity (PHU), whichever is reached first. In future applications, we believe that the values given in this chapter for the crop-specific parameters should be used for the crop species of interest. The performance of the model with the large number of data sets used in this chapter supports the generality of these input parameters. PHU, when it is used, will have to be determined based on maturity type or from a measured maturity date.

This chapter reports on three accomplishments. First the response of corn (*Zea mays* L.) grain yield to soil loss was demonstrated for three locations. Ten years of generated weather data (Richardson and Wright 1984) were used, and the depth of the soil profile was decreased from 94 to 72 cm. Second, the measured and simulated grain yields for six crop species were compared. Finally, the ability of the model to simulate corn yield response to irrigation was demonstrated for four arid locations in the United States. The measured data represent work by researchers from several disciplines in several countries (table 13.1). Their cooperation in sharing this information is deeply appreciated.

The Penman method of simulating potential evapotranspiration was used in all but one case. In testing the rice (*Oryza sativa* L.) yields, lack of wind data necessitated use of the Priestly-Taylor equation.

Table 13.1

Data for rice, sunflower, barley, and soybean
used for yield demonstration of the EPIC model

Crop	Location	Years	Researchers
Corn	Yuma, AZ	1974-1975	Stewart et al. (1976)
	Davis, CA	1974-1975	Stewart et al. (1976)
	Fort Collins, CO	1974-1975	Stewart et al. (1976)
	Logan, UT	1974-1975	Stewart et al. (1976)
	Mandan, ND	1968-1970	Allessi & Power (1975)
	Florence, SC	1980-1982	Karlen & Camp (unpubl.)
	Temple, TX	1979	Pietsch & Gerik (1980)
	Bushland, TX	1975-1977	Musick & Dusek (1980)
Wheat	Phoenix, AZ	1977-1978	Dusek (unpubl.)
	Garden City, KS	1980-1981	Wagger (1983)
	Hutchinson, KS	1979-1980	Wagger (1983)
	Manhattan, KS	1981	Wagger & Kissel (unpubl.)
	Pendleton, OR	1980-1981	Klepper et al. (1983)
	Bushland, TX	1977	Musick & Dusek (unpubl.)
	Temple, TX	1977	Monk, Arkin, Maas, & Ritchie (unpubl.)
	Lind, WA	1976	Johnson (1978)
Pullman, WA	1972	Thill (1976)	
Rice	Far East, Southeast Asia, Southern Asia, South America	1983-1984	Oldeman et al. (1986)
Sunflowers, Barley	Toulouse, France	1983-1986	INRA-Toulouse, France (unpubl.)
Sunflowers, Soybeans	Toulouse, France	1983-1986	INRA-Toulouse, France (unpubl.)
Soybeans	Ringold, IA	1963-1969	Laflen (unpubl.)

VALUES FOR PARAMETERS

Tables 13.2 and 13.3 list the input values that describe each crop. Only PHU varies among cultivars within a species. Thus, while the number of these inputs is great, only one has to be adjusted for the proper cultivar for a location.

Wetland rice, partially because of its unusual soil environment, was often the divergent species for a parameter. Noteworthy cases where rice differed from other species were for the two points on the leaf area development curve, LAP1 and LAP2; the second point on the frost damage curve, FRS2; the critical labile P concentration, CPF; the critical aeration factor, CAF; and maximum rooting depth, RDMX.

Values for PHU were either entered or calculated for a reported measured harvest date (table 13.3). For the calculation, harvest was assumed to occur at maturity. Values for corn were mostly entered, with extremes being 1020 for Mandan and 2835 for Yuma. The PHU for all of the wheat (*Triticum aestivum* L.) runs were calculated from the reported harvest date and ranged from 1463 to 2690.

Rice was unusual in that all the values for PHU were entered. A preliminary test of the data indicated that the values for PHU from planting to reported dates of maturity fell into two groups. The means for the two groups were approximately 2100 and 1600. Thus, these values were used for the runs. With only two exceptions, all those locations in the 2100 PHU group were at latitudes greater than 20 degrees. Those in the 1600 PHU group, with one exception, were at latitudes less than 20 degrees. The variety IR36 has been shown to be sensitive to photoperiod, with a 7.5-day delay in flowering per hour of increase in photoperiod above 14 h (Vergara and Chang 1985). Thus, photoperiod must be at least partially responsible for the differences in development rate at the different latitudes.

The PHU calculations for sunflower (*Helianthus annuus* L.), soybeans (*Glycine max* (L.) Merr.), and barley (*Hordeum vulgare* L.) were based on the reported harvest dates. These values can be a guide for further applications of EPIC.

Table 13.2
 Pertinent crop parameters used in the EPIC runs

Parameter	Crop					
	Corn	Wheat	Rice	Sun-flower	Soybeans	Barley
WA (biomass energy ratio)	40.0	35.0	20.0	60.0	25.0	25.0
HI (harvest index)	0.50	0.42	0.50	0.25	0.31	0.42
TB (optimal temp. for growth)	25.0	15.0	24.0	25.0	25.0	15.0
TG (minimum temp. for growth)	8.0	0.0	8.0	6.0	10.0	0.0
DMLA (maximum potential LAI)	5.0	8.0	6.5	5.0	9.0	7.0
DLAI (fraction of season leaf area declines)	0.80	0.80	0.78	0.55	0.60	0.75
LAP1 (1st point-leaf area curve)	15.05	15.01	20.01	15.01	15.01	15.01
LAP2 (2nd point-leaf area curve)	50.95	50.95	70.95	50.95	50.95	50.95
FRS1 (1st point-frost damage curve)	5.01	5.01	1.50	5.15	5.01	5.01
FRS2 (2nd point-frost damage curve)	15.05	15.10	2.95	15.95	15.05	15.10
RLAD (rate of LAI decline)	1.00	1.00	0.50	1.00	1.00	1.00
RBMD (rate of biomass decline)	1.00	2.00	0.10	2.00	0.50	2.00
ALT (aluminum tolerance index)	3.0	2.0	3.0	3.0	3.0	1.0
CPF (critical labile P conc.)	22.5	22.5	25.0	22.5	22.5	22.5

Table 13.2--Continued
 Pertinent crop parameters used in the EPIC runs

Parameter	Crop					
	Corn	Wheat	Rice	Sun- flower	Soybeans	Barley
CAF (critical aeration factor)	0.85	0.85	1.0	0.85	0.85	0.85
SDW (seeding rate)	20.0	90.0	50.0	8.0	37.0	90.0
HMX (maximum height)	2.5	1.2	0.8	2.5	1.5	1.2
RDMX (maximum root depth)	2.0	2.0	0.9	2.0	2.0	2.0
CVM (C factor for water erosion)	0.20	0.03	0.05	0.20	0.30	0.05
CNY (fraction of N in yield)	0.0175	0.023	0.013	0.028	0.061	0.0189
CPY (fraction of P in yield)	0.0025	0.0033	0.005	0.0061	0.0059	0.0044
WSYF (water stress--yield factor)	0.050	0.010	0.010	0.010	0.010	0.010
PST (pest factor)	0.95	0.95	0.95	0.95	0.095	0.95
WCY (water in yield fraction)	0.15	0.12	0.14	0.00	0.00	0.00
BN1 (N uptake at emergence)	0.044	0.060	0.05	0.05	0.0524	0.06
BN2 (N uptake at 0.5 maturity)	0.0164	0.0231	0.0200	0.0230	0.0320	0.0231
BN3 (N uptake at maturity)	0.0128	0.0134	0.0100	0.0146	0.0286	0.0130
BP1 (P uptake at emergence)	0.0062	0.0084	0.0060	0.0063	0.0074	0.0084

Table 13.2--Continued
 Pertinent crop parameters used in the EPIC runs

Parameter	Crop					
	Corn	Wheat	Rice	Sun- flower	Soybeans	Barley
BP2 (P uptake at 0.5 maturity)	0.0023	0.0032	0.0030	0.0029	0.0037	0.0032
BP3 (P uptake at maturity)	0.0018	0.0019	0.0018	0.0023	0.0035	0.0019
BW1 (wind erosion for standing live)	0.433	3.39	3.39	3.39	1.266	3.39
BW2 (wind erosion for standing dead)	0.433	3.39	3.39	3.39	0.633	3.39
BW3 (wind erosion for flat residue)	0.213	1.61	0.32	1.61	0.729	1.61
IDC (crop category number)	4	5	4	4	1	5

Table 13.3
 Values of heat units (PHU) from planting
 to maturity for various locations and years

Crop	Location	PHU ¹
Corn	Florence, SC	2000
	Bushland, TX	2000
	Columbia, MO	1820
	Mandan, ND	1020 ²
	Bloomington, IL	1970 ²
	Logan, UT	1625
	Davis, CA	1760
	Fort Collins, CO	1205
	Yuma, AZ	2835 ²
Wheat	Pullman, WA	1790-2690 ²
	Pendleton, OR	1710-1962 ²
	Garden City, KS	1614-1835 ²
	Hutchinson, KS	1463 ²
	Manhattan, KS	1942 ²
	Bushland, TX	1650-1965 ²
	Temple, TX	1502 ²
	Phoenix, AZ	1485-2346 ²
Rice	Cuttack, India	2100
	Coimbatore, India	2100
	Kapurthala, India	2100
	Nanjing, China	2100
	Muara, Indonesia	2100
	Parwanipur, Nepal	2100
	Sakha, Egypt	2100
	Suweon, South Korea	2100
	Milyang, South Korea	2100
	Ahero, Kenya	1600
	Palmira, Columbia	1600
	Pintung, China	1600
	Sanpatong, Thailand	1600
	Los Banos, Philippines	1600
Masapang, Philippines	1600	
Sunflower	France	1442-1849 ²
Soybeans	France	1123-1282 ²
	Ringold, IA	1576 ²
Barley	France	1524-2000 ²

¹ Entered values, unless otherwise noted.

² Values were the resulting calculated values based on the input date of harvest.

SIMULATING CORN GRAIN YIELD RESPONSE TO SOIL DEPTH

The simulations for corn were made to demonstrate the effect of soil depth on the grain yield in three contrasting locations in the United States. The soil used was 94 cm deep and was a typical silt loam with uniform soil characteristics throughout the profile. For each location, the yield was predicted for 13 consecutive years of generated weather. Only results from the last 10 years were then used in the analysis. This was done three times with the same weather data, and 7, 14, or 22 cm of soil was removed from the 94-cm soil profile each time. The surface layer was maintained at 15 cm. Each soil profile was given a runoff curve number appropriate for its eroded condition. Soil water was set at field capacity in the first of the 13 years and not reinitialized throughout the 13 years. The three locations and their mean annual rainfall during the simulations (figure 13.1) were Columbia, MO, 95 cm; Temple, TX, 88 cm; and Bushland, TX, 43 cm. These means are similar to the long term normals for the locations, i.e., 97, 86, and 46 cm, respectively (National Oceanic and Atmospheric Administration 1977).

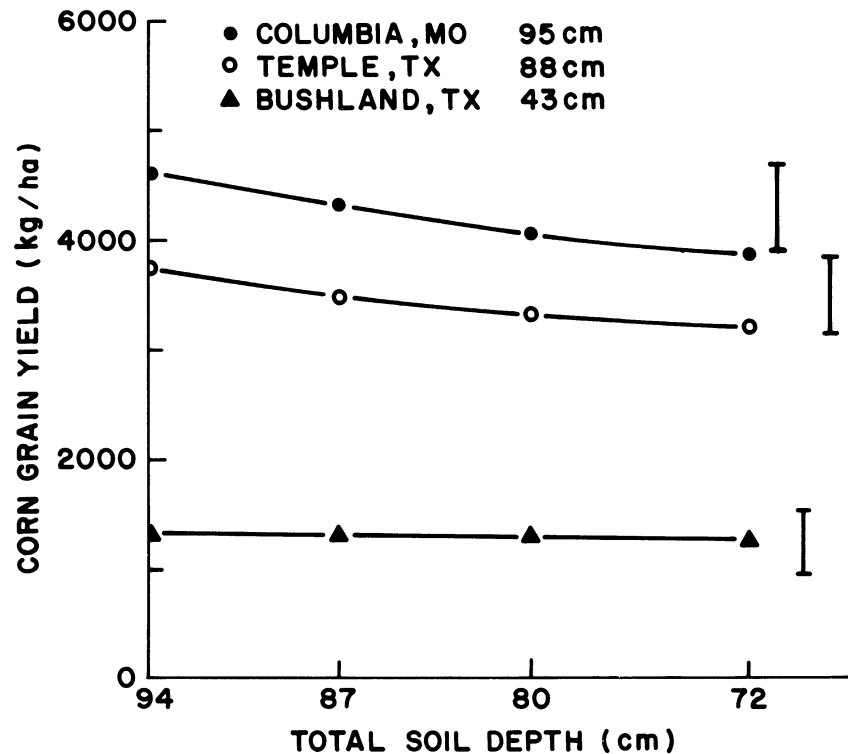

Figure 13.1
Simulated corn grain yield as a function of a total depth of a silt loam soil at 3 locations. Vertical bars represent least significant differences.

The model simulated a gradual drop in mean yield at the two locations with the most rainfall and almost no drop in yield at Bushland. This was expected, as total amount of soil-water-holding capacity in the profile was a limitation only in the first two locations. Even a profile of 72 cm was deep enough to accommodate the limited water at Bushland.

Perhaps the most noteworthy aspect of this analysis was the magnitude of the variability associated with each mean yield, as evidenced by the large least significant difference (LSD) values. At all three locations, yield did not significantly differ among soil depths. The effect of weather on grain yield has previously been shown to be a major deterrent to yield prediction by a simple productivity index (Kiniry et al. 1983). Thus, a process-oriented, weather-dependent model such as EPIC, run for a large number of years, appears to be the most feasible means of quantifying response of yield to erosion.

SIMULATING GRAIN YIELD OF SIX CROP SPECIES

The first approach used to evaluate EPIC yield simulations was to compare the mean and standard deviation (SD) of the simulated yields of a crop with the same statistics for measured yields. Closeness between measured and predicted yields for these two statistics is important when making long-term management decisions. A consistent bias would decrease model effectiveness.

EPIC's mean simulated yields were always close to the mean measured yields (table 13.4). The means differed by 7% or less. Except for soybeans, mean simulated yield for each crop was less than the mean measured value. The difference between the measured and simulated means was smallest for wheat and greatest for sunflower.

The SD's of the simulated yields were also similar to the SD's of the measured, but the percentage differences between simulated and measured were greater in general for the SD's than for the means. Two exceptions to this were sunflower and corn, with 0 to 3% differences in SD. The greatest difference, 42%, was for barley. The other three crops had differences of 14 to 25%.

Regression of simulated yield on measured yield provided another valuable technique of describing model performance. The first aspect of this approach was to check for a significant relationship between simulated and predicted yields. This consisted of testing whether the slope of the regression line was significantly different from zero. If it was not, the model failed to show any superiority over simply using the mean measured yield for prediction.

Table 13.4
Means and standard deviations of measured
and simulated yields for the 6 crop species

Crop	N	Yield			
		Measured		Simulated	
		\bar{x}	SD	\bar{x}	SD
----- tons/ha -----					
Corn	83	6.4	3.6	6.1	3.5
Wheat	20	3.8	2.1	3.7	1.8
Rice	33	5.6	1.7	5.3	1.3
Sunflower	27	2.9	0.9	2.7	0.9
Barley	19	3.5	1.2	3.3	0.7
Soybeans	10	2.1	0.4	2.2	0.3

Once it was established that there was a significant, positive slope for the regression line, the next step was to check how the line compared with the ideal line through the origin with a slope of 1.0. This provided a check for bias in the simulations. Such was accomplished by constructing a confidence band for the regression line and checking to see if the ideal line was outside this band.

Finally, the r^2 was computed to find what fraction of the variance in simulated yield could be attributed to its linear regression on measured yield. It also gave an indication of what fraction of the variability in simulated yields could not be accounted for by the measured yields. If the slope was significantly different from zero and the ideal line fell within the confidence band, the r^2 provided the final means of describing how well the simulated and measured yields agreed.

The quantity of data for each of the crop species studied differed considerably (figure 13.2). The species with the most was corn, with 83 data sets. The species with the least was soybeans with 10. A limitation with two of the crop species, soybeans and barley, was the narrow range of measured yields. Measured soybean yields ranged from 1.5 to 3 Mg/ha. Excluding

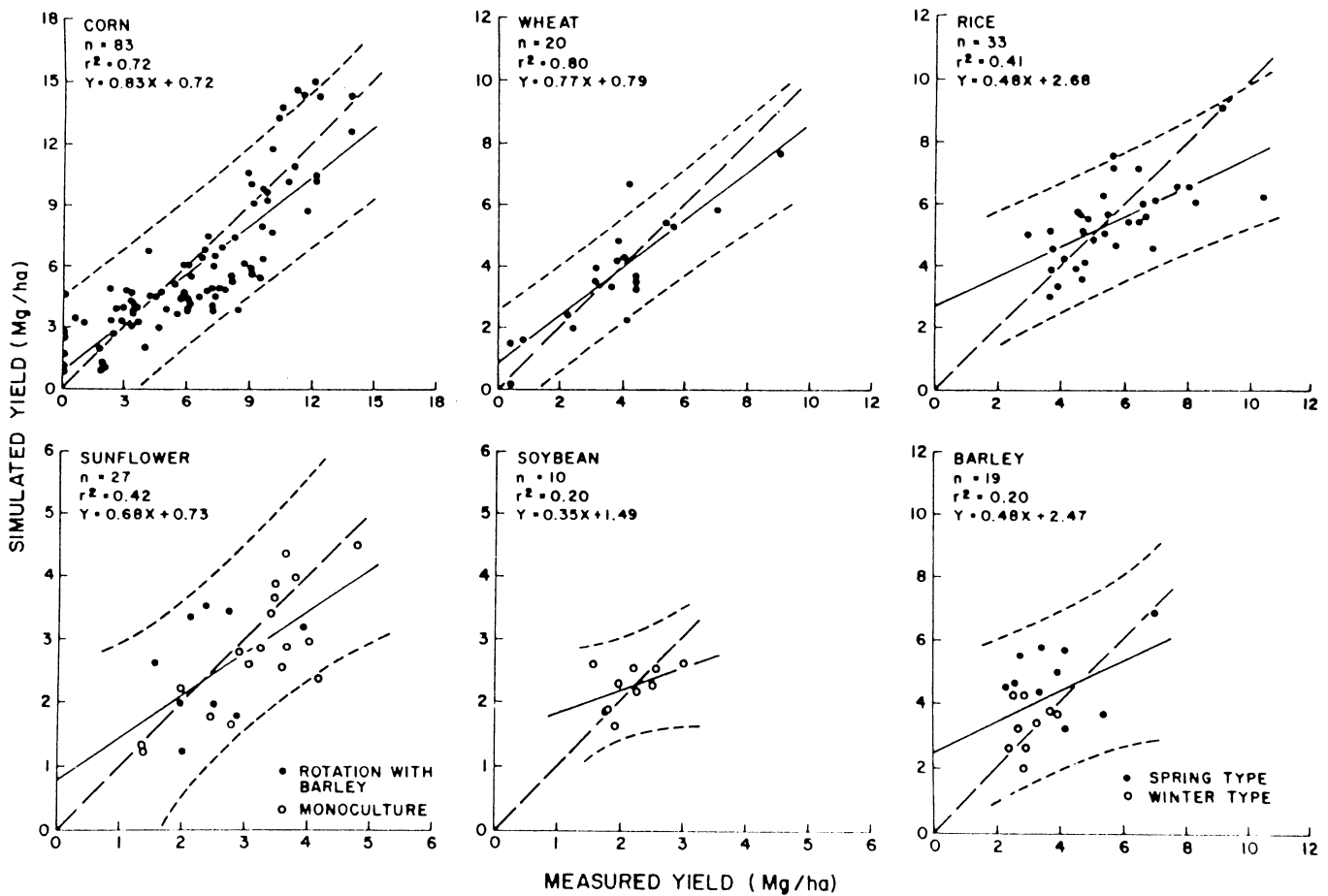

Figure 13.2
 Relationship between measured and simulated yield of several crops. In each plot, the curvilinear broken lines delineate the 95% confidence band, the broken straight line represents the ideal 1:1 relationship, and the solid straight line represents the fitted regression line.

the two highest yield data sets, yield of barley ranged only from 2.4 to 4.2 Mg/ha. For both data sets, the variation in measured yield was too small to be accounted by the model. Thus, we did not anticipate a large r^2 for the simulated:measured relationship. Instead, the simple fact that the simulated yield was not consistently biased above or below the measured was deemed as evidence that the model was working satisfactorily.

EPIC simulated corn yields reasonably well throughout the range of measured yields. Measured yields ranged from zero in some dryland studies in the Southwestern United States to almost 14 Mg/ha at two irrigated sites. The slope was significantly different from zero at the 95% confidence level. The value of r^2 was high (0.72), and the fitted line was close to the 1:1 line. The 1:1 line fell well within the 95% confidence band for the regression line. EPIC was able to adequately simulate yield in arid, dryland conditions with yield near zero and in high-management irrigated conditions.

Results with wheat were similar to those with corn. Measured yields varied widely, with some less than 1 Mg/ha and one of 9 Mg/ha. Again measured and predicted yields were significantly related. The value of r^2 was 0.80 and the fitted line fell within the 95% confidence band for the regression line. Measured yields in both the high and low yielding environments were simulated reasonably well. There appeared to be no large bias at high, low, or medium ranges of measured yields.

Data for rice (*Oryza sativa* (L.)) was a subset from a multilocation wetland study done by the International Rice Research Institute (Oldeman et al. 1986). These data were collected at locations in the Philippines, Asia, Africa, and South America. Testing was done using 33 of the original 63 data sets. Those not included had unusual problems with pests or disease, unusual management practices, or some other anomaly. Only data for the standard variety IR36 were included; however, two values for PHU were used, as discussed above. As in the previous two comparisons, measured and simulated yields were significantly related. The value of r^2 was not as high, 0.41, but the 1:1 line was within the 95% confidence band except in the extreme upper range of the data. The simulated yields tended to be lower than the measured yields in the higher yielding environments. However, EPIC simulated the second highest measured yield nearly exactly. The low value for the slope of the regression line, 0.48, implied that the model was not as responsive to the environment as it should have been.

Simulated yields of sunflower were also significantly related to the measured yields. The r^2 , 0.42, was similar to the value for rice. The regression line was close to the 1:1 line and within the 95% confidence band throughout the range of the data. Simulated yields were similar to measured yields at both the lowest and the highest values.

As mentioned above, the small range of measured yields of soybeans and barley restricted the amount of variability the model could account for and thus restricted the r^2 . Slopes for the simulated:measured regression line were not significantly different from zero for either crop. The values for r^2 were low, 0.20 for both crops. However, there was no obvious bias in simulated yields and the 1:1 line fell within the confidence band for both crops. EPIC, therefore, failed to account for the small variability in yield of these two crops but tended to give a reasonable average yield.

SIMULATING CORN GRAIN YIELD RESPONSE TO IRRIGATION

These simulations were designed to demonstrate the capability of the model to describe the response of yield to irrigation. The data came from a four-location, 2-year study involving a wide range of irrigation levels and measured yields (Stewart et al. 1977). These were regions of high evaporative demand and were thus a good test of the water balance.

With the Davis, CA, data (figure 13.3), the model showed a yield response to irrigation similar to that shown by the measured yields throughout the range of irrigation applications. At the lowest values, the model tended to slightly underpredict grain yield. In contrast, the high yielding treatments were slightly overpredicted. However, EPIC in general seemed capable of simulating the effects of water stress on grain yield reasonably well.

The simulated yields for Logan, UT, were closely aligned with the measured yields in the lowest irrigation treatments. Similar to the results at Davis, the model showed a yield response throughout the range of irrigation levels. With these data, however, the simulated yields were lower than the measured values in the high yielding treatments.

The simulated yields for Fort Collins, CO, were closer to measured yields in 1975 than in 1974. In all but the lowest yielding treatment in 1974, measured yields were considerably greater than simulated. It appeared that the simulated evaporative demand was too great or the entered soil-water-holding capacity was too low in 1974.

Finally, EPIC predicted too great a yield response to irrigation in Yuma, AZ, in 1974. Between the lowest and highest level of irrigation, measured yields increased only 1.6 Mg/ha while the model simulated a 5.6 Mg/ha increase. However both simulated and measured yields showed some yield response throughout the range of irrigation treatments.

OVERALL CONCLUSIONS

The crop yield simulation model of EPIC appeared to be quite adequate for the purposes for which it was designed. The model predicted the trend of decreasing corn grain yield with increased erosion. The model gave reasonably accurate grain yield predictions for corn, wheat, rice, sunflower, soybeans, and barley in a wide range of environments. Finally, the model simulated the response of corn yield to irrigation and appeared to be an effective tool for irrigation scheduling. The authors believe the crop model will be useful in many practical applications.

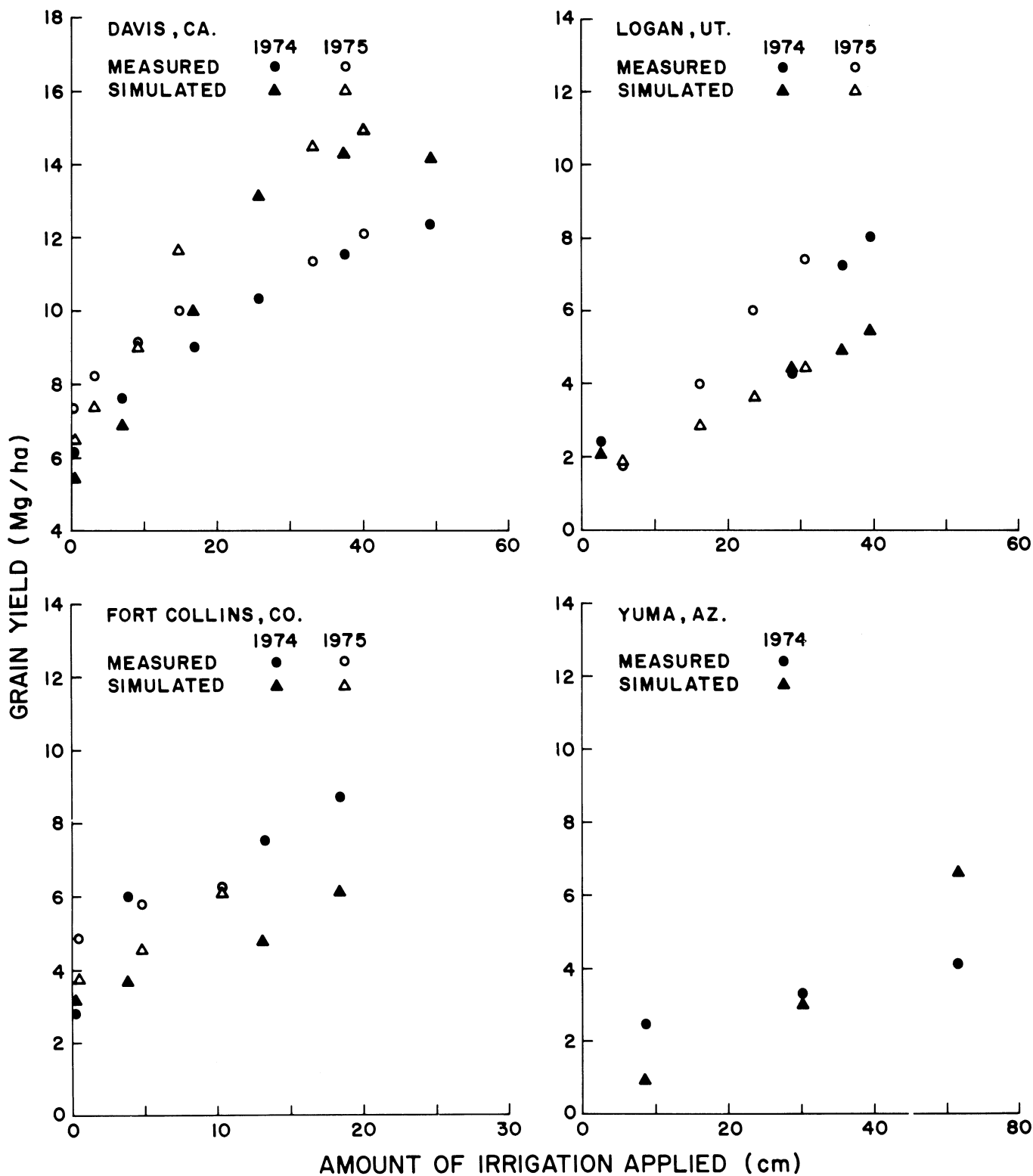

Figure 13.3
 Measured and simulated corn grain yield as a function of amount of irrigation water applied at four locations.

REFERENCES

- Alessi, J. and J.F. Power. 1975. Effects of plant population, row spacing and relative maturity on dryland corn in the Northern Plains. I. Corn forage and grain yield. *Agron. J.* 66:316-319.
- Johnson, R.C. 1978. Apparent photosynthesis and evapotranspiration of winter wheat in a field environment. M.S. Thesis, Washington State Univ., Pullman.
- Kiniry, L.N., C.L. Scrivner, and M.E. Keener. 1983. A soil productivity index based upon predicted water depletion and root growth. *Univ. Missouri Agric. Exp. Sta. Res. Bull.* 1051.
- Klepper, B., T.W. Tucker, and B.D. Dunbar. 1983. A numerical index to assess early inflorescence development in wheat. *Crop Sci.* 23:206-208.
- Musick, J.T. and D.A. Dusek. 1980. Irrigated corn yield response to water. *Trans. ASAE* 23:92-98, 103.
- National Oceanic and Atmospheric Administration. 1977. Climatic atlas of the United States, 80 pp.
- Oldeman, L.R., D.V. Seshu, and F.B. Cady. 1986. Response of rice to weather variables. *Int. Rice Res. Inst. Report*, Manila, Phillipines.
- Pietsch, D. and T.J. Gerik. 1980. Corn hybrid performance. *Texas Agric. Exp. Bull.*
- Richardson, C.W. and D.A. Wright. 1984. WGEN: A model for generating daily weather variables. U.S. Dep. Agric., Agric. Res. Serv., ARS-8, 83 pp.
- Stewart, J.I., R.J. Hanks, R.E. Danielson, and others. 1977. Optimizing crop production through control of water and salinity levels in the soil. *Utah Water Res. Lab. PRWG* 151-1, 191 pp.
- Thill, D.C. 1976. Physiological and environmental effects of yield potential in early- and late-planted winter wheat. M.S. Thesis, Washington State Univ., Pullman.
- Vergara, B.S. and T.T. Chang. 1985. The flowering response of the rice plant to photoperiod. *Int. Rice Res. Inst.*, Manila, Phillipines. 61 pp.
- Wagger, M.G. 1983. Nitrogen cycling in the plant-soil system. Ph.D. Thesis, Kansas State Univ., Manhattan.

14. PERSPECTIVES

A.N. Sharpley and J.R. Williams

The preceding documentation gives further details on certain aspects of the EPIC model. The model is operational and has produced reasonable results under a variety of climatic conditions, soil characteristics, and management practices. The EPIC Model was used to analyze the relationships among erosion, productivity, and fertilizer needs as part of the Soil and Water Resources Conservation Act (RCA) analysis for 1985. EPIC has provided erosion-productivity relationships for about 900 benchmark soils and 500,000 crop/tillage/conservation strategies as input to the Center for Agricultural and Rural Development (CARD) model (English et al. 1982).

EPIC has many potential uses beyond the RCA analysis including: (a) national level conservation policy studies; (b) national level program planning and evaluation; (c) project level planning and design; and (d) as a research tool.

REFERENCE

English, C.B., K. F. Alt, and B.O. Heady. 1982. A documentation of the Resources Conservation Act's assessment model of regional agricultural production land and water use, and soil loss. Center for Agricultural and Rural Development Report 107T.

Ag84Te
c.2

5



United States
Department of
Agriculture

Agricultural
Research
Service

Technical
Bulletin
Number 1768

EPIC—Erosion/Productivity Impact Calculator

2. User Manual

RECORDS
BRANCH

JUN 17 '91

USDA
RECEIVED

ABSTRACT

Williams, J. R., P. T. Dyke, W. W. Fuchs, V. W. Benson, O. W. Rice, and E. D. Taylor. 1990. EPIC--Erosion/Productivity Impact Calculator: 2. User Manual. A. N. Sharpley and J. R. Williams, Editors. U. S. Department of Agriculture Technical Bulletin No. 1768. 127 pp.

This publication describes how to use the EPIC model, which predicts the impact of erosion on soil productivity. The model simulates erosion, plant growth, and related processes; it also makes economic assessments, such as cost of erosion.

KEYWORDS: erosion, hydrology, model simulation, nutrients, plant growth, productivity, tillage, weather

While supplies last, single copies of this publication may be obtained from USDA-ARS, Grassland , Soil and Water Research Laboratory, 808 East Blackland Road, Temple, Road, Springfield, VA 22161.

Copies of this publication may also be purchased from the National Technical Information Service, 5285 Port Royal Road, Springfield, VA 22161.

Mention of trade names or commercial products is solely for the purpose of providing specific information and does not imply recommendation or endorsement by the U. S. Department of Agriculture.

CONTENTS

Introduction	1
Model operation.....	1
Subprogram descriptions	3
Input data	5
Table VII.1. Basic EPIC-user-supplied data set	5
Table VII.2. Output selection	10
Table VII.3. Experimental parameters and economic data	11
Table VII.4. Farm machinery information	11
Table VII.5. Crop parameters	12
Table VII.6. Multiperiod simulation controls	12
Entry and assembly system for EPIC (EASE)	12
EPIC output	12
EPIC applications	13
References	13
Appendix I: Weather	15
AppendixII: Hydrology	25
Appendix III: Crop data	31
Appendix IV: Soils	35
Appendix V: Farm machinery	47
Appendix VI: Water erosion	51
Appendix VII: Description of EPIC input data	55
AppendixVIII: EPIC input data forms	67
Appendix IX: Output variable definitions	85
Appendix X: EASE user instructions	93
Appendix XI: Example input data	101
Appendix XII: Example output	115

EPIC--EPIC/PRODUCTIVITY IMPACT CALCULATOR

2. User Manual

J. R. Williams, P. T. Dyke,
W. W. Fuchs, V. W. Benson,
O. W. Rice, and E. D. Taylor¹

INTRODUCTION

A mathematical model called EPIC (Erosion/Productivity Impact Calculator) was developed recently to predict the relationship between soil erosion and soil productivity throughout the United States (Williams 1985; Williams and Renard 1985; Williams et al. 1983, 1984a, 1984b). To accomplish this complex objective, the goals set in model development were that the model be--

- Physically based and capable of simultaneously and realistically simulating the processes involved in erosion by using readily available inputs;
- Capable of simulating the processes as they would occur over hundreds of years, if necessary, because erosion can occur relatively slowly;
- Applicable to a wide range of soils, climates, and crops encountered in the United States; and
- Computationally efficient, convenient to use, and capable of assessing the effects of management changes on erosion and soil productivity.

These goals were met; and as a result, EPIC is also useful as both a decision-making tool and a research tool. As a decision-making tool--from the farm level to the national level--EPIC can help identify optimal management strategies concerning any of the following: drainage, irrigation, water yield, erosion control (wind and water), weather, fertilizer and lime applications, pest control, planting dates, tillage, and crop residue management. As a research tool, EPIC can be used in developing, testing, and refining model components for simulating various physical and chemical processes; in sensitivity analyses to determine the importance of experimental variables and their interactions; and in designing field experiments to obtain maximum information for the minimum cost.

EPIC is composed of physically based components for simulating erosion, plant growth, and related processes and economic components for assessing the cost of erosion, determining optimal management strategies, etc. The EPIC components include weather simulation, hydrology, erosion-sedimentation, nutrient cycling, plant growth, tillage, soil temperature, economics, and plant environment control. A detailed description of each component is given in volume 1, which documents the model. The details of using the model are given here.

The EPIC computer program, EASE (Entry and Assembly System for EPIC), weather generation parameters for 134 locations in the United States, parameters for 22 crops, input data for 50 types of farm equipment, and soils data for 737 soils are available upon request.² Table 1 of appendix I (table I.1) is an example of the data needed to generate air temperature, precipitation, and solar radiation, and table I.2 contains a list of the 134 locations. Table I.3 is an example of the data needed to generate wind velocity and direction, and table I.4 is a list of 174 locations where wind data are available. Examples of crop and equipment data are shown in tables III.1 and V.1. Table IV.1 is an example of the soils data, and table IV.2 lists the 737 soils.

MODEL OPERATION

EPIC is a fairly comprehensive model developed specifically to predict, or estimate, the long-term relationship between erosion and productivity. Two approaches are used to estimate the erosion/productivity relationship (E/P), and both involve plotting values of a term called erosion/productivity index (EPI) on the y axis against corresponding values for erosion on the x axis. In the first approach, based on the work of Perrins et al. (1985), EPI is defined as the ratio of annual crop yield from an eroded field to the annual yield from the noneroded field; and EPI values obtained over a long period (≈ 100 years) are plotted against the corresponding cumulative values of EPIC-estimated soil erosion. In the second approach, EPI is defined as the ratio of mean crop yield for an eroded soil profile to the mean crop yield for the soil profile at the start of an EPIC simulation. To accomplish the EPI estimate, the first step is to perform simulations with the initial soil properties held constant for some time period (20-50 years). This simulation provides an estimate of the mean annual crop yield as well as a frequency distribution of yields. The second step is to simulate erosion for some time period (25-100 years) to obtain an estimate of the eroded soil properties. Step one is repeated exactly except the original soil profile is replaced by the eroded profile. Comparing the resulting mean crop yield to that obtained with

¹ Hydraulic engineer, USDA-ARS; agricultural economist, Texas Agricultural Experiment Station; soil scientist (retired), USDA-SCS; agricultural economist, USDA-SCS; soil scientist, USDA-SCS; and computer assistant, USDA-ARS, respectively.

² Write to USDA-ARS, Grassland, Soil and Water Research Laboratory, 808 East Blackland Road, Temple, TX 76502.

the original profile gives one EPI point on the E/P. The process is repeated to give as many EPI values as needed to adequately define E/P.

To facilitate E/P estimation by either approach, a special multiperiod simulation mode was developed for EPIC. Any number of simulations of various durations can be performed for the same site without restarting the model. This mode of operation requires weather generation and provides the same weather for each of the simulations so that a fair comparison of crop yields is assured. Erosion can be adjusted from zero to a multiple of the normal EPIC estimate. If erosion is shut off, the model automatically operates with static soil properties. Actually, the soil properties at the start of the no-erosion simulation are reinitiated at the beginning of each year. This static soil mode allows crop-yield frequency distribution to be conveniently estimated. To save time in simulating soil profile erosion (second step of second approach), both the wind and water erosion estimates may be increased to some multiple of the normal erosion rates. This increase is accomplished by setting the water erosion conservation practice factor and the wind erosion factor to some number greater than 1. Since these factors are linear, simulation time may be reduced linearly without causing large differences in results. For example, if the factors are set at 10, only 10 years of simulation are required to arrive at an eroded profile similar to one resulting from 100 years of simulation with the factors set at 1.0. For long-term simulations (≈ 1000 years), this shortcut saves considerable time and usually gives satisfactory results.

Since the E/P estimate may require simulating many processes that take place over years even with shortcut approaches, computing efficiency was a primary consideration in EPIC development. Thus, the model operates on a daily time step and uses the simplest and most efficient components available that will give adequate results.

The drainage area considered by EPIC is generally small (≈ 1 ha) because soils and management effects are assumed to be spatially homogeneous. In the vertical direction, however, the model is capable of working with any variation in soil properties, the soil profile being divided into a maximum of 10 layers whose thicknesses can be varied. When erosion occurs, the second layer thickness is reduced by the amount of the eroded thickness, and the top layer properties are adjusted by interpolation (according to the distance the first layer is moved into the second layer). When the second layer thickness becomes zero, the top layer starts moving into the third layer, etc.

The crop parameter table contains information needed for simulating the production of 22 crops. The table can be expanded to include any number of crops without increasing the computer program storage requirements. Any combination of the 22 crops in rotations (up to 10 years) may be simulated. As many as three crops may be grown during one calendar year.

The following are some of the features of EPIC:

- An interactive data entry system, EASE (Entry and Assembly System for EPIC), is available to aid in building EPIC data sets.
- Special input data forms are available and were developed for use with EASE.
- The model can be used with a wide variety of mainframe and PC computers.
- Inputs are readily available. Also, the model is designed to run on minimum data sets when some inputs are missing.
- The weather data may be inputted or generated. Almost any combination of inputting and generating weather variables is possible. Also, a weather variable may be inputted for part of the simulation and generated for the remainder.
- The same weather sequence may be repeated for any number of simulations at the same site, or a new weather sequence may be generated for each simulation.
- Daily, monthly, or annual output may be specified. Also, the output increment may be set for any number of days (N days) or any number of years (N years). For example, it may be desirable to see outputs every 5 days for detailed comparisons of crop growth data. It is also possible to operate the N-day print interval during the growing season only. The N-year interval is quite useful for long-term simulations involving slow processes like pine tree growth.
- Output variables may be selected, or standard output is available.
- Dryland agriculture or irrigation by sprinkler or furrow may be simulated. Also, irrigation can be specified by date and rate or operated automatically according to plant stress, time between applications, upper and lower application limits, and annual limits.
- Drainage and furrow diking systems may be simulated.
- Lime may be applied automatically.
- Fertilizer may be applied either at specified dates and rates or automatically according to plant stress, time between applications, and maximum annual limits.
- The EPIC farm equipment table contains data for about 50 types of equipment for use in simulations. Any type of farm equipment may be added to the table, or existing equipment data may be modified.

- Weather generation parameters are available for 134 locations in the United States. EASE automatically inserts these parameters into the EPIC data set for the site selected.
- Data are available for 737 soils. EASE automatically inserts the selected soils data into the EPIC data set.
- Water erosion is estimated by three different methods. Any one of the three may be designated to interact with or drive other model components.
- Wind erosion may be simulated.

SUBPROGRAM DESCRIPTIONS

The EPIC main program and 83 subprograms contain about 4450 FORTRAN statements. The main program reads data, initializes variables, and calls subprograms to do the daily simulation and to summarize and output data. For convenience, the subprograms are placed into eight groups in alphabetical order. The group names are adjacent, crop, erosion, hydrology, nutrients, soil, tillage, and weather. The first letter of each subprogram name is the first letter of the appropriate group name. A brief description of the operation of each subprogram follows. Complete details of the equations used to describe the processes involved are given in volume 1, chapter 2.

Block DATA- subroutine--Initializes variables that are in common.

Subroutine ADAJ--computes the day of the year, given the month and the day of the month.

Function ADSTG--provides numbers from a gamma distribution, given two random numbers.

Function ADSTN--computes a standard normal deviate, given two random numbers.

Function AEXPO--avoids computer underflow and overflow problems in solving the EXP function.

Subroutine AICL--computes the day of the month, given the month and day of the year.

Subroutine AISHF--shuffles data randomly.

Subroutine AISPL--splits dual-purpose integer-input variables into two separate variables.

Function ARALT--interpolates monthly values of daylight hours, average temperature, and maximum solar radiation to provide daily values.

Subroutine ARESET--resets initial values of state variables for each simulation. Used with multiperiod simulation option.

Subroutine ASCRV--computes S curve parameters given two (x,y) points.

Subroutine ASORT--sorts numbers into ascending order using ripple sort.

Function ASPLT--splits dual-purpose real-input variables into two separate variables.

Function ATRI--generates numbers from a triangular distribution, given x-axis points at start and end and peak y value.

Function AUNIF--provides random numbers ranging from 0.0 to 1.0.

Subroutine AXMON--determines the month, given the day of the year.

Subroutine CAGRO--calculates the daily increases in plant biomass, root weight, and yield by adjusting the potential values with the active stress constraint.

Function CAHU--accumulates heat units for use in CPTHU.

Subroutine CFRG--determines minimum stress factors for root and total biomass growth.

Subroutine CGROW--calculates leaf area index, heat units, root depth, and temperature stress for the crop.

Subroutine CPTHU--uses planting and harvest dates and average monthly temperature to calculate the potential heat units for each crop before daily simulation starts.

Function CRGBD--calculates root growth stresses caused by temperature, aluminum toxicity, and soil strength and determines the active constraint on root growth (the minimum stress factor).

Subroutine CROP--predicts daily potential growth of total plant biomass and roots.

Subroutine CSTRS--calculates plant stress factors caused by limited N, P, air, and water and determines the active constraint (minimum stress factor--N, P, water, or temperature). Calls NFIX and NAFTA (automatic fertilizer option).

Function EAJL--called by ESLOS to calculate the amount of material added to the top layer and removed from the second layer.

Subroutine ESLOS--calculates the thickness of soil removed by each erosion event, moves the top layer into the second layer by a distance equal to the eroded thickness, and adjusts the top layer soil properties by interpolation. When the second layer is reduced to a thickness of 10 mm, it is placed in the third layer.

Subroutine EWER--estimates daily soil loss caused by wind erosion, given the average wind velocity and direction.

Function EWIK--estimates the soil erodibility factor for the wind erosion.

Subroutine EYSED--predicts daily soil loss caused by water erosion and estimates the nutrient enrichment ratio.

Subroutine HCNSLP--adjusts CN2--The Soil Conservation Service (SCS) runoff curve number that applies to average moisture conditions (U.S. Department of Agriculture, Soil Conservation Service 1972)--for watershed slope and computes CN1 (dry conditions) and CN3 (wet conditions).

Subroutine HEVP--estimates the amount of soil-water evaporation and the potential plant-water evaporation.

Subroutine HFURD--computes the storage volume of furrow dikes, given dike interval and height, ridge height, and slope.

Subroutine HIRG--simulates automatic or user specified irrigation applications. Also estimates erosion and runoff.

Subroutine HPERC--computes percolation and lateral subsurface flow from a soil layer when field capacity is exceeded.

Subroutine HPKRN--computes percolation by crackflow.

Subroutine HPURK--the master percolation component (manages the routing of water through soil layers).

Subroutine HRFEI--estimates the USLE rainfall energy factor, given daily rainfall.

Subroutine HSNOM--predicts daily snowmelt when the average air temperature exceeds 0°C.

Subroutine HSWBL--checks the soil-water balance at the end of a simulation.

Subroutine HSWU--distributes plant-water evaporation through the root zone and calculates actual plant-water use based on soil-water availability.

Subroutine HUSE--the master water and nutrient use subroutine. Calls HSWU and NUPPO for each soil layer.

Subroutine HVOLQ--predicts daily runoff volume and peak runoff rate, given daily precipitation and snowmelt.

Subroutine HWTBL--simulates water table dynamics as a function of rainfall and evaporation.

Subroutine NAFT--applies fertilizer automatically based on user-specified plant stress level, annual limit, and soil test.

Subroutine NAJN--computes actual N plant uptake from each layer (uptake = lower of the values determined for plant demand and soil supply).

Subroutine NBL--computes the N and P balances at the end of the simulation.

Subroutine NCONC--computes parameters of an equation describing the N and P relations to biomass accumulation.

Subroutine NDNIT--estimates daily loss of NO₃ by denitrification.

Subroutine NEVN--estimates upward NO₃ movement caused by soil evaporation.

Subroutine NFALL--simulates the falling of standing dead-crop residue to the ground to become part of the surface layer's residue.

Subroutine NFERT--applies N and P fertilizer at specified dates, rates, and depth.

Subroutine NFIX--estimates N fixation for legumes.

Subroutine NLCH--estimates daily NO₃ leaching by percolation and lateral subsurface flow for all layers except the surface layer.

Subroutine NLIMA--estimates aluminum saturation using base saturation, organic carbon, and pH.

Subroutine NLIME--applies lime to neutralize toxic aluminum levels or to raise soil pH to near optimal levels.

Subroutine NNMIM--estimates daily N and P mineralization and immobilization, considering fresh organic material (crop residue) and active and stable humus material.

Subroutine NPCY--the master nutrient-cycling subroutine. Calls NPMIN, NYNIT, NLCH, NNMIM, and NDNIT for each soil layer.

Subroutine NPMIN--computes P flux between the labile, active mineral, and stable mineral P pools.

Subroutine NPUP--calculates the daily P demand for optimal plant growth.

Function NRSNT--assures that N and P concentrations in crop residue are within previously established bounds.

Subroutine NUP--calculates the daily N demand for optimal plant growth.

Subroutine NUPPO--calculates the daily potential soil supply of P for each layer.

Subroutine NUTS--calculates the plant stress factor caused by limited supply of N or P.

Subroutine NYNIT--estimates daily NO₃ leaching by percolation and lateral subsurface flow and NO₃ loss in runoff for the surface layer.

Subroutine NYON--predicts daily organic N and humus losses, given soil loss and enrichment ratio.

Subroutine NYPA--predicts daily P loss, given soil loss and enrichment ratio.

Subroutine SAJBD--simulates the change in bulk density within the plow layer caused by rainfall-induced settling.

Subroutine SOLIO--outputs the soil property table.

Subroutine SOLT--estimates daily average temperature at the middepth of each soil layer.

Subroutine SPLA--splits soil layers in an attempt to maintain desired number of layers. May operate on initial profile or profile after a layer has been removed by erosion.

Subroutine SPOFC--maintains correct relation between soil porosity and field capacity.

Subroutine SPRNT--prepares soil data table for output, and converts weights of materials to concentrations.

Subroutine THVST--computes N and P contents of crop residue (above ground and roots) after harvest.

Subroutine TLOP--controls all tillage operations, including planting, harvesting, and automatic fertilizer applications at planting.

Subroutine TMIX--mixes N, P, and crop residue within the plow depth according to the mixing efficiency of the implement; calculates the change in bulk density; converts standing residue to flat residue; and estimates the implement's effect on ridge height and interval.

Subroutine TRDST--converts standing live crop to standing dead residue, converts root weight to residue, and zeros crop growth accumulators at harvest.

Subroutine WGN--master subroutine for weather simulation. Maintains proper relation among weather variables.

Subroutine WIND--simulates daily average wind direction.

Function WRAIN--computes daily precipitation amount from skewed normal distribution.

Subroutine WRLHUM--simulates daily average relative humidity from triangular distribution.

Subroutine WRWD--predicts daily rainfall occurrence and provides modified exponential distribution as an option for simulating rainfall amount.

Subroutine WSOLRA--simulates daily solar radiation from normal distribution.

Subroutine WTAIR--simulates daily maximum and minimum air temperatures from normal distribution.

INPUT DATA

Appendix VII contains five tables that briefly describe all EPIC input requirements, including definitions of variables, formats, line numbers, units, typical ranges, and sources of information. The basic data set supplied by the EPIC user is described in table VII.1. Tables VII.2-VII.6 are available and can be used in many situations with little or no user adjustment. Thus, many users, particularly the inexperienced, will be concerned with table VII.1 only.

The EPIC model provides considerable flexibility in input requirements. For example, the model is capable of estimating several inputs that may not be readily available for some locations. Also, alternative solutions that require less data are offered in some cases.

The following discussion expands on the material presented in appendix VII to assist the new EPIC user in assembling data. Data items are discussed in the same sequence as they appear in the tables and have corresponding numbers.

Table VII.1. Basic EPIC-User-Supplied Data Set

1. Title

The first datum required is the title, which can be the location, the soil type, management strategies, or any other information the user chooses to input. For convenience in identifying the data sets on output files, the first eight columns of line 2 are reserved for the file name.

2. Program Control Codes

Next the user must specify seven program control codes. The number of years of simulation (NBYR) can be from 1 to several hundred. However, 20 to 30 years may be adequate for estimating frequency distributions used to solve many problems. The EPIC runs for the analyses made in response to the Soil and Water Resources Conservation Act (RCA) were for 100 years each.

The beginning year (IYR) can be any number. Sometimes it is convenient to begin simulations on year 1. Of course, in simulating systems with data measured over a definite period, the actual beginning year of record is used.

The beginning month (IBM) and day (IDM) can be any date during the year. Most long-term simulations start on January 1. Starting after January 1 may be convenient if data for the system to be simulated are recorded only during the growing season (crop research plots, for example).

The print code (IPD) allows the user to specify daily, monthly, or annual output. Annual printouts minimize the output volume and are adequate for most long-term simulations. Monthly outputs enable the user to evaluate model performance within the growing season or to examine runoff, erosion, etc., more closely than annual printouts. Monthly outputs are normally obtained in short-term (1-10 year) simulations and are particularly useful in model testing. For some long-term crops like pine trees, even annual printouts may not be necessary. An N-year output interval is obtained by inputting NIPD. For example, a 5-year interval of monthly printouts is specified by the number 53. A 5-year interval of annual printouts is specified by 51. A 1-year output interval need not be specified; but if the 1 is omitted, all farming operations will be printed by date for each year of simulation. The outputs specified by codes N2, N4, and N5 are provided to allow closer inspection of changes in soil properties. These outputs are most useful in research work. The main purpose of the daily outputs is error detection, but they are also useful for examining within-growing season conditions. Caution should be exercised in specifying daily output for runs longer than 1 year to avoid excessive printout. An option to print at K-day intervals is also available. For example, 106 provides outputs at 10-day intervals. Other options include printing soil properties only and printing them only during the growing season.

The weather input code (NGN) consists of the identification numbers of the input weather variables. The variables and their identification numbers are rainfall (1), maximum and minimum air temperatures (2), solar radiation (3), wind speed (4), and relative humidity (5). Since the other weather variables are rainfall dependent, rainfall must be inputted if any other variable is inputted. Thus, it is not necessary to include ID = 1 in NGN unless rainfall is the only input variable. Some example NGN values and their definitions are

NGN	Input variables
1	Rainfall
2	Rainfall and maximum and minimum temperatures
4352	All five
2300	Rainfall, maximum and minimum temperatures, and solar radiation
0	All variables generated

Note that the identification numbers may occupy any space in the 4-column field and may be in any sequence.

Most simulations used in decision-making specify NGN = 0 (all weather variables are generated) because the weather generator is reliable, gives realistic results, and is far more convenient than inputting weather. Values of NGN > 0 are mainly used in model testing and other research studies for which onsite weather data are available.

The random-number-generator code (IGN) indicates the number of times the random-number generators are cycled before the simulation begins. The random-number-generator seeds (which are a set of random numbers) are contained in the EPIC program data statements. If IGN = 0, the simulation begins with those seeds. Setting IGN > 0 allows the user to start each simulation with different seeds if desired; that is, each time the generators cycle, they produce a new set of seeds. This feature is convenient for simulating several different weather sequences at a particular location. It also allows repeated simulation of the same weather sequence so that various management strategies may be compared (the weather sequences are identical for any number of simulations at a given site if IGN is not changed).

3. General Data

The first general data item (DA) is the watershed area. Usually DA is small because EPIC assumes homogeneous soils and management.

The runoff curve number (CN2) is the SCS curve number for antecedent moisture condition 2. Data in table II.1 are used in estimating CN2. Also, table II.1 contains estimates of CN2 for row crops and small grain for the soil described. As stated in the Introduction, table IV.1 information is available for the 737 soils listed in table IV.2.

The channel length (CHL) is the distance along the channel from the outlet to the most distant point on the watershed. Often in small areas (≈ 1 ha) there is no defined channel. In such cases the length is measured along a concentrated flow path or is simply estimated from the length/width ratio of the watershed. For areas ≤ 20 ha, the channel length measurement is not critical.

The average channel slope (CHS) is computed by dividing the difference in elevation between the watershed outlet and the most distant point by CHL. For small areas, CHS, like CHL, is not critical, because both these measurements are only used in estimating the watershed time of concentration. Most of the time of concentration is due to overland rather than channel flow in small watersheds.

The channel roughness factor (CHN) and the surface roughness factor (SN) are Manning's n values. Table II.2 contains suggested values of Manning's n for various conditions.

The peak runoff-rate/rainfall-energy adjustment factor (APM) provides a means for fine tuning the energy factors used in estimating water erosion. Normally, an APM value of 1.0 gives satisfactory results. However, since the maximum 0.5-h rainfall records (tables I.1 and I.2) are generally short (≈ 8 years), adjustment may be needed occasionally. To determine whether adjustment is necessary, the user should make one long-term (50-year) simulation with APM = 1.0 and compare the simulated, average annual rainfall erosion index (EI) with the annual EI taken from figure 1 of appendix I (fig. I.1) (making sure to convert fig. I.3 values to metric units). If the simulated and map EI

values are within 10% of one another, the APM needs no adjustment. For larger differences, APM should be adjusted before more runs are made at that particular location. The new value of APM is computed by dividing the map-obtained EI by the simulated, average annual EI. Usually, APM should be within 0.5 and 1.5, regardless of the ratio (the ratio is only an approximation because there are several nonlinear functions involved).

The latitude of the watershed (YLT) is site specific and, thus, user supplied.

The average watershed elevation (ELEV) should be inputted if Penman's approach is used to estimate potential evaporation. ELEV should be set to 0. when the Priestley-Taylor method is used.

The water content of snow on the ground at the beginning of a simulation (SNO) is user specified. For long-term simulations, such as those for decision making, SNO is usually not known; but generally, the estimate is not critical. If a measured value of SNO is available at the beginning of a simulation, it should be used.

The average concentration of N in rainfall (RCN) may vary slightly for different locations. However, since the rainfall N contribution is a relatively small component of the N cycle, a value of 0.8 ppm is generally satisfactory. Of course, the user is free to insert site-specific concentrations if the information is available.

The number of years of cultivation before the simulation starts (RTN) is used to estimate the fraction of the organic N pool that is mineralizable.

4. Water Erosion Data

The watershed slope length (SL) can be estimated by field measurement as described by Wischmeier and Smith (1978) or from topographic maps using the contour-extreme point method (Williams and Berndt 1977).

The next variable, S, serves two purposes. Numbers before the decimal specify which water erosion equation [USLE (2), MUSLE (0), or Onstad-Foster (1)] interacts with other model components. Erosion is estimated with all three equations, but only one is linked to other model components. Numbers after the decimal give the average watershed slope. The average watershed slope (S) can also be estimated from field measurement or by using the grid-contour method (Williams and Berndt 1977).

The erosion-control-practice factor (PEC) normally ranges from about 0.1 to 1.0, depending on the effectiveness of the conservation practice. However, PEC can be set to 0.0 to eliminate water erosion entirely. When this is done, the soil profile remains relatively static because it is reset to initial conditions at the end of each year. This feature is very convenient for estimating the crop-yield frequency distribution for a given soil profile. At the other extreme (PEC=10), erosion rates are increased 10 times to improve long-term simulation efficiency. This feature is a big

time saver in estimating water erosion effects on soil properties over periods of up to 1000 years. Obviously, the 1000-year period can be approximated with a 100-year simulation using PEC=10. Values of PEC provided by Wischmeier and Smith (1978) are contained in table VI.1.

5. Weather Data

Data needed to generate peak runoff rate, rainfall intensity, air temperature, precipitation, solar radiation, and relative humidity are given in tables I.1 and I.2 for 134 locations. The TP-40 (Hershfield 1961) 10-year-frequency rainfall amounts for 0.5 h (TP5) and 6 h (TP6) are used to simulate peak runoff rate and rainfall intensity. Values of TP5 and TP6 can be obtained for locations not included in tables I.1 and I.2 from figures I.1 and I.2.

The number of years of maximum monthly 0.5-h rainfall available (TP24) can be obtained from the U.S. Department of Commerce (1979). Values of TP24 available in 1982 are shown in table I.1.

The variable BTA is used to estimate the probability of a wet day occurring after a dry day and the probability of a wet day occurring after a wet day (wet-dry rainfall probabilities) if the only information available is the average monthly number of wet days. Generally the number of wet days is much more readily available than the wet-dry rainfall probabilities. A value of 0.75 for BTA usually gives satisfactory estimates of the wet-dry probabilities.

The variable EXPK is used to modify the exponential distribution of rainfall amount. The modified exponential distribution is used to generate rainfall amounts if the standard deviation and skew coefficient are not available. An EXPK value of 1.3 gives satisfactory results for many locations.

Monthly averages used in generating temperature, precipitation, relative humidity, and radiation appear in table I.1 in the order required as inputted into EPIC. Several options are available for assembling data for locations not included in table I.2. However, a core data set must be inputted for all options. These essential data are monthly averages for maximum and minimum temperatures (TMX and TMN), precipitation amount (RAIN), and solar radiation (RAD) and the maximum monthly rainfall for 0.5-h duration (P5MX). If daily weather is inputted (NGN > 0), the monthly average number of days of rainfall (DAYP) must be added to the core data set. If the temperature standard deviations are not available, EPIC will accept the extreme monthly temperatures (EXMX and EXMN) and use them to estimate the standard deviations. If precipitation is to be generated, the monthly average standard deviation of daily rainfall (SDRF) and the skew coefficient (SKCF) are inputted if available. If SDRF and SKCF are not available, those lines may be left blank, and EPIC will generate precipitation using a modified exponential rather than the skewed normal distribution. The options for inputting weather data are summarized in table I.1. The footnotes indicate which

data items may be omitted for various operating modes. The footnotes also describe substitution of extreme temperatures for standard deviations and the ability to generate rainfall if STDV and SKCF are not available. When data are omitted, there must be a blank line in the data set (13 lines of weather data are always required).

Sources of weather data for locations not included in table I.2 are listed below.

TMX	"Climatological data. National Summary" (U.S. Department of Commerce 1978)
TMN	Daily temperature records
STMX	Daily temperature records
STMN	Daily temperature records
EXMX	"Climatic Atlas of the United States"
EXMN	(U.S. Department of Commerce 1968)
RAIN	"Climatological data. National Summary" U.S. Department of Commerce 1978)
SDRF	Daily rainfall records
SKCF	Daily rainfall records
PW/D	Daily rainfall records
PW/W	Daily rainfall records
DAYP	"Climatic Atlas of the United States" (U.S. Department of Commerce 1968)
P5MX	Maximum short duration rainfall (U.S. Department of Commerce 1979)
RAD	"Climatic Atlas of the United States" (U.S. Department of Commerce 1968) Also "Climates of the States" (Water Information Center, Inc. 1974)
RH	"Climatic Atlas of the United States" (U.S. Department of Commerce 1968)

A computer program is available for the user to process daily weather records and obtain the required monthly information.

6. Wind Erosion Data

If wind erosion is to be considered, field dimensions and orientation must be specified. Wind erosion is not simulated if the wind erosion adjustment factor (ACW) is zero. If wind erosion is simulated for specific sites, FL, FW, and ANG can be measured easily. However, hypothetical sites are often used in long-term simulations associated with large-scale decision-making. In such cases, values of FL, FW, and ANG should be chosen to represent typical field

configurations of the area. Efforts to match field dimensions and drainage area are not necessary. The field dimensions are used only to estimate wind erosion, with the exception that FL is used to estimate water erosion from furrow irrigation. Thus, the simulation site may be a small area (1 ha) in a field of 1 x 0.5 km. It should also be noted that the change in simulated wind erosion is not large for any FL > 0.3 km. Therefore, the estimation of inputs for FL and FW is not usually critical for fields with areas greater than about 10 ha. When fields larger than 10 ha are stripcropped, however, the estimation of FW becomes more important. To evaluate the effect of stripcropping, FW is estimated as the average width of the strips.

The STD variable allows input of initial, standing dead-crop residue.

The power parameter (SWV) of the modified, exponential wind-speed distribution ranges from about 0.3 to about 0.7. A value of 0.5 usually gives satisfactory estimates of daily wind speed.

The climatic factor (CF) is inputted only rarely; that is, only when the normal wind erosion equation value is not desired. Usually, CF is set to 0.0, and the model computes the proper value as suggested in the wind erosion component description (volume 1).

The wind erosion adjustment factor (ACW) is used along with PEC values to shut off or accelerate erosion. Wind erosion can be shut off by setting ACW = 0.0. Also, ACW can be increased to a high level (ACW = 10) as a shortcut in estimating wind erosion effects on the soil profile. Since ACW is related linearly to wind erosion, 1000 years' simulations can be approximated by 100 years' simulation using ACW = 10.

The remaining wind erosion data--i.e., average monthly wind velocity (WVL) and monthly wind direction distribution (DIR)--are given for one location, as an example, in table I.3. Such data are available for the locations shown in table I.4. Data for other locations are available from the "Climatic Atlas of the United States" (U.S. Department of Commerce 1968).

7. Soil Data

Most of the soil data can be obtained from tables IV.1 and IV.2. Other sources of soil data are the Soil Survey Investigation Reports (U.S. Department of Agriculture, Soil Conservation Service 1966). However, some data must be supplied by the user.

The maximum number of soil layers (TSLA) may range from 3 to 10. If TSLA is not inputted, the model automatically uses 10 layers. If less than TSLA layers are inputted, the model splits layers to obtain the proper number. Layers are split in half from the soil surface downward. The model splits the first layer with thickness greater than ZOT (user-specified minimum thickness for splitting). As soil layers are eroded and lost from the system, layer splitting con-

tinues until the number of layers equals TSLA. This splitting scheme produces thinner layers near the soil surface throughout the simulation period. Since most activity (tillage, root growth, microbial activity, rainfall/runoff interaction, etc.) occurs relatively near the soil surface, concentrating computational effort in that zone by using thin layers is very desirable. When the thickest soil layer reaches ZQT, no further splitting occurs. Instead, the number of soil layers is reduced until only two layers remain. At that time, the simulation stops. The simulation will also stop if the user-specified, minimum soil-profile thickness (ZF) is reached. If ZQT and ZF are not inputted, the model sets both of them to 0.1 m.

The initial soil water content can be inputted by setting the fraction of field capacity (FFC) at any value between 0 and 1. If FFC=0, EPIC estimates the initial soil water based on average annual rainfall. Usually, FFC is inputted only for research purposes, and the initial soil water content must be known.

In areas where the water table enters the root zone, the minimum (WTMN) and maximum (WTMX) water table depths from the surface are inputted. EPIC simulates water table fluctuations between these limits according to 30-day accumulations of rainfall and potential evaporation. If known, the initial water table depth (WTBL) is inputted. In areas not affected by a high water table, no inputs are required. Instead, EPIC sets WTMN=50 m, WTMX=100 m, and WTBL=75 m. These depths assure that the water table has no effect on the root zone.

The soil weathering factor (XIDS) is used to provide information for estimating the phosphorus sorption ratio (PSP). If no weathering information is available or if the soil contains CaCO₃, XIDS is left blank. In the absence of weathering information, EPIC estimates PSP=0.5. For soils that contain no CaCO₃, the setting should be XIDS=1, 2, or 3 to indicate slight, moderate, or high weathering. The PSP values can be inputted directly by setting XIDS=4.

All soil layer thicknesses are user assigned. Usually, the depths from the surface to the layer bottoms (Z) are assigned to coincide with the soil data in tables IV.1 and IV.2.

The remaining inputs describe soil properties in each layer. Much of this information is in tables IV.1 and IV.2. However, the nitrate concentration (WNO3), labile phosphorus concentration (AP), crop residue (RSD), oven-dry bulk density (BDD), PSP, saturated conductivity (SC), subsurface flow travel time (RT), and organic phosphorus concentration (WP) are user supplied. Information about these variables is not generally available. Therefore, EPIC is designed to make reasonable estimates of the variables if the user has no information. The input option exists for special applications in which at least one of the variables is available (usually research purposes). The input option does not require data for all layers. For example, if only the surface crop residue is known, that information is inputted for the top layer. EPIC will accept the information and use it to assign residue amounts to lower layers.

8. Management Information

Operation Codes

The operation codes indicate which management options are to be used in the simulation. The number of years of a crop rotation (NRO) may vary from 1 to 10 and is usually no more than 4 in decision-making applications. However, in model tests involving research results, it is common for NRO to equal the number of years of record because any change in management (crop, fertilizer application, planting and harvest dates, or tillage) requires a separate year in the rotation.

The irrigation code (IRR) is used to specify the irrigation strategy--sprinkler, furrow, or dryland. There are two modes of irrigating--manual and automatic. If automatic irrigation is selected, IRI is the minimum application interval in days. If manual irrigation is selected, IRI may be 0 or 2. If IRI=0, the user specifies the irrigation dates and volumes of water to be used. If IRI=2, the user specifies the irrigation dates and volume also, but the volume of water applied will be the lesser of the volumes between the specified input volume and the volume needed to fill the soil field capacity.

If automatic fertilizer application is desired, IFA is the minimum fertilizer application interval in days. Lime can also be applied automatically by setting LM=0 or not applied at all by setting LM=1.

To provide a furrow diking system, a setting of IFD=1 is used. Furrow diking is not considered if IFD is left blank.

The drainage code (IDR) is zero without drainage. If a drainage system is installed, IDR is the soil layer number containing the system.

Operation Variables

The operation variables are used to trigger and set limits on the selected management options. To trigger automatic irrigation, the water stress factor (BIR) is set to a stress level between 0 and 1. When the plant water stress factor reaches BIR, the plants may be irrigated. If manual irrigation is selected, BIR is left blank. The irrigation runoff ratio (EFI) specifies the fraction of each irrigation application that is lost to runoff. Annual irrigation volumes can be limited by VIMX, the maximum allowed for each crop. If VIMX is left blank, EPIC assigns it a value of 2000 mm. Individual irrigation applications are regulated by ARMN and ARMX, the minimum and maximum volumes allowed for single applications. If these limits are not supplied, EPIC sets ARMN=0 and ARMX=1000 mm.

The automatic fertilizer trigger (BFT) functions much like BIR for irrigation. When the plant nitrogen stress level reaches BFT, nitrogen fertilizer may be applied automatically. When the manual fertilizer option is selected, BFT is left blank. The maximum annual N fertilizer rate for a crop is specified by FMX. If FMX is not inputted, it is set to 200 kg ha⁻¹. At planting time, enough N fertilizer is applied to bring the root zone concentration up to a level (FNP) equal a fraction of FMX.

If a drainage system is installed, the time in days required to eliminate plant stress caused by poor aeration is inputted as DRT. When furrow dikes are constructed, some fraction (FDSF) of the total volume is available for water storage. There are several reasons why the total volume is not available for storage--(1) the dikes are not perfectly constructed, (2) the field slope is not uniform, (3) dike and furrow side slopes may not be triangular as assumed, (4) dike and furrow settling after construction is not usually uniform, as estimated by EPIC, and (5) the dikes may be randomly damaged by humans or animals. FDSF allows the user to compensate for varying field conditions and provides for conservative or optimistic dike system design.

Operation Schedule

The operation schedule is a complete description of irrigation, fertilizer, and tillage operations that make up the crop rotation. For example, for each year of the crop rotation, manual irrigation application volumes are inputted in order of date; next, the manual fertilizer applications are listed by date giving rate and depth; and finally, the tillage operations are listed by date and identification number. For planting operations, the crop identification number, the time to maturity (tree crops only), and the potential heat units (optional) are also inputted. If potential heat units are not inputted, EPIC calculates the values by using monthly average temperatures between planting and harvest. For tree crops only, the time in years between planting and harvest is inputted with the harvest operation. A new runoff curve number (CN2) value may be inputted with each tillage operation. This is generally not necessary unless the operation causes a drastic change in soil properties (deep chiseling) or crops (pasture to row crop). The last line in each of the operation schedules (irrigation, fertilization, and tillage) is blank. If automatic irrigation or fertilization is specified, of course, that operation is not scheduled.

One, two, or three operation schedules per year of rotation are possible; however, the number of schedules must not vary from year to year. For example, two operation schedules are required to input manual irrigation and tillage. Therefore, irrigation and tillage must be scheduled each year of the rotation. If no operations are planned for a particular year, a blank line is still required for each operation schedule. Up to 20 irrigation applications, fertilizer applications, and tillage operations may be performed during a year. These operations may be scheduled on any day. Actually, several operations may occur on the same day.

9. Daily Weather Data

Daily weather (precipitation, maximum and minimum air temperatures, solar radiation, wind speed, and relative humidity) may be inputted for each day of the simulation. The options for selecting input weather variables were discussed in relation to NGN (see section 2 on Program Control Codes). To provide greater flexibility, particularly in estimating missing data, the input selection can be over-

ridden if $NGN > 0$. Daily rainfall and maximum and minimum air temperatures are generated on days with input values of 999. In some rare cases, the days with rainfall events can be identified, although not the rainfall amounts. Rainfall amounts can be generated for these days by inputting a negative value. Solar radiation, wind speed, and relative humidity values are generated on days with zero or blank input. Thus, it is possible to input any weather variable during part of the simulation and generate it for the remaining missing days. Since all other weather variables depend on rainfall, it is not possible to input any of the other variables if rainfall is missing. On the other hand, if any or all of the other variables are inputted on a given day and rainfall has a value of 999, all variables will be generated. A similar rule applies to maximum and minimum temperature--if either is missing, both must be generated. Inputting weather data is not recommended for normal EPIC applications like decision-making. The general lack of long-term data prohibits its use in most locations. However, inputting weather can be quite useful in model testing and other research activities that deal with short-term data.

Table VII.2. Output Selection

The output selection codes contained in the PRNT1758 file allow selection of accumulated or average variables (KA), state variables (KS), or daily variables (KD). The selection numbers and variable names of the accumulated or average variables are

- 1 - TMX --maximum temperature
- 2 - TMN -- minimum temperature
- 3 - RAD -- solar radiation
- 4 - RAIN -- rainfall
- 5 - SNOW -- snowfall
- 6 - Q -- runoff
- 7 - SSF -- subsurface flow
- 8 - PRK -- percolation
- 9 - ET -- evapotranspiration
- 10 - EP -- plant water evaporation
- 13 - EI -- rainfall energy
- 14 - MUSLE -- water erosion (modified USLE)
- 15 - C -- crop cover factor
- 16 - YW -- wind erosion
- 17 - YON -- N loss with sediment
- 18 - YNO3 -- NO₃ loss in runoff
- 19 - SSFN -- NO₃ loss in subsurface flow
- 20 - PKRN -- NO₃ leached
- 21 - MNN -- N mineralized
- 22 - IMN -- N immobilized
- 23 - DN -- denitrification
- 24 - NFIX -- N fixation
- 25 - UNO3 -- N uptake by crop
- 26 - HMN -- humus mineralization
- 28 - YP -- P loss with sediment
- 29 - YAP -- labile P loss in runoff
- 30 - UPP -- P uptake by crop

- 31 - MNP -- P mineralized
- 32 - IMP -- P immobilized
- 40 - TMP -- temperature in second soil layer
- 43 - RHUM -- relative humidity
- 45 - RSDK -- residue decayed
- 47 - AOF -- water erosion (Onstad-Foster)
- 48 - USLE -- water erosion (USLE)
- 51 - WVW -- wind speed
- 52 - FALF -- leaf fall
- 53 - PEP -- potential plant water evaporation

Up to 30 variables may be selected from this list to output accumulations or averages. The selection numbers and names of the state variables are

- 11 - SW -- soil water content
- 12 - WTBL -- water table
- 27 - TNO3 -- NO₃ in soil
- 33 - HU -- heat units
- 34 - LAI -- leaf area index
- 35 - RD -- root depth
- 36 - RW -- root weight
- 37 - BIOM -- crop biomass
- 38 - RSD -- flat residue
- 39 - STD -- standing residue
- 50 - STL -- above-ground crop biomass

Up to 10 variables may be selected from this list to output state variables. The accumulated and average variables and the state variables are outputted monthly or annually and appear in the summary tables. The daily output includes selections from both of the above lists plus those from:

- 60 - WS -- water stress
- 61 - NS -- N stress
- 62 - PS -- P stress
- 63 - TS -- temperature stress
- 64 - AS -- aluminum toxicity stress
- 65 - REG -- minimum stress factor

A standard EPIC output is available and can be obtained by making no selections (five blank lines are entered). To omit all accumulated and average variables from the output, -1 is entered as the first selection (columns 1-4, line 1). To omit all state variables, -1 is entered in columns 1-4, line 3. Daily output is controlled by the program control code IPD (table 1.2).

Table VII.3. Experimental Parameters and Economic Data

The experimental parameters contained in the file PARM1578 are composed of 14 sets of two points describing S-curve shapes and 14 miscellaneous parameters. These parameters are used mainly in developing and

modifying the model. Ideally, they will become constants of the model and require no further adjustment. The values of most of the parameters are well established now. Therefore, only the most experienced EPIC users should consider modifying parameter values. As constants are established, the parameters may be assigned to other model components for further testing. Thus, it is essential to match the parameter table and the EPIC version used. The 14 (SCRP) variables give two points on an S curve that vary from 0 to 1 on the y axis and may have any scale on the x axis. For example $SCRP(2,1) = 5.5$ and $SCRP(2,2) = 50.95$ means that at 5% on the x axis the y value is 0.50 and at 50% on the x axis the y value is 0.95. The S curve is convenient, flexible, and reliable, and it fits many natural processes well.

The economic data are costs of various input materials and are subject to frequent change because costs vary with time and over geographic regions. Users should change these values freely to best fit their situation.

Table VII.4. Farm Machinery Information

The EPIC farm machinery table (table V.1 and TILL1758 file) lists about 50 types of equipment and associated data. Up to 20 types of equipment can be used in a simulation. However, the table can be expanded to include any number of types of equipment, and the data can be modified easily. Equipment can simply be added to the table as desired, or existing data can be changed to better suit local conditions.

In table VII.4, the first data item (TIL) is the equipment name (any name with eight characters or less). Typical tillage operations for any location in the United States can be found in the enterprise budget generator (Kletke 1979).

The next data item (COTL) is the total cost of the tillage operation in dollars per hectare.

The mixing efficiency of the operation (EMX) is the fraction of materials (crop residue and nutrients) that is mixed uniformly in the plow depth of the implement. Suggested values for EMX, random roughness (RR), tillage depth (TLD), ridge height (RHT), and ridge interval (RIN) are given in table V.1. However, since these values may vary with soils and management, modification may be needed.

The dike height (DKH) and dike interval (DKI) are inputted for tillage operations that create furrow dikes. Dike heights are usually slightly less than ridge heights, and dike intervals are management dependent.

The operation code (IHC) provides for planting in rows or for drilling, harvesting, and building and destroying furrow dikes. There are two methods of harvest: IHC = 2 harvests and allows the crop to continue growing; IHC = 1 harvests and kills the crop.

Harvest efficiency (HE) is the ratio of crop yield removed from the field to total crop yield. Besides its normal function, harvest efficiency can be used in simulating grazing ($HE \approx 0.1$) or growing green manure crops ($HE = 0.0$).

Near optimal harvest index values (HI) are contained in table III.1. As the crop grows, these values may be adjusted for water stress. For some crops like hay, the harvest index is not affected by water stress and should maintain the table III.1 value. Thus, the harvest index override (ORHI) is used to give a constant harvest index. Another important feature of ORHI is the provision for two different types of harvest of the same crop. For example, the seed could be removed from a crop and then later the straw could be baled. The water stress-adjusted HI is appropriate for the seed harvest but probably not for baling the straw. Thus, two separate harvest machines are required. The second harvester sets $ORHI \approx 0.9$ to override the adjusted HI used in the first harvest.

Table VII.5. Crop Parameters

The source of information for table VII.5 is the EPIC crop parameter table (table III.1 and file CROP1758). Table III.1 lists the parameters for 22 crops, and those for other crops or crop varieties may be added if available. Crop parameters may be evaluated according to field experiments and information reported in scientific literature or by interpolation between data for similar crops contained in table III.1. There is no limit to the number of crops that may be included in the table. However, no more than 11 crops may be included in a crop rotation schedule for an EPIC simulation. Besides adding new crops or varieties, one may choose to modify existing parameters. Although modification is easy, caution is advised because parameter values are fairly well established for most of the crops. Many times new EPIC users are tempted to modify crop parameters to quickly adjust simulated crop yield. Differences between observed and simulated crop yields may be caused by any number of incorrectly simulated processes or by input errors. Thus, one should inspect input and output very carefully before adjusting crop parameters. Crop parameter adjustment is not generally recommended except for research purposes like crop variety experiments or sensitivity analyses.

Table VII.6. Multiperiod Simulation Controls

The model is designed to run any number of simulations for a site without reloading the computer program. As described in the Model Operation section, this feature is particularly useful in estimating E/P. Another potentially important application is in establishing realistic initial conditions for certain variables. A short simulation (1-10 years) may provide better estimates of soil water, nutrient content, etc., at the start of the simulation of interest. Input data include (1) the number of years of the simulation (NBYR), (2) the water erosion control practice factor (PEC), and (3) the wind erosion adjustment factor (ACW).

Each line of input contained in the MLRN1758 file initiates a new simulation period of length = NBYR. The last line must be blank. The PEC and ACW variables are used to control erosion and to indicate static or dynamic soil properties. The PEC values normally range from about 0.1 to 1.0, depending on the effectiveness of the conservation

practice. However, PEC can be set to 0.0 to eliminate water erosion entirely. This also holds some soil properties relatively static--they are reset to initial conditions at the end of each year. The reset properties include organic content (N, P, and C) and the stable mineral P pool. Other, more dynamic, soil components like water, nitrate, and labile P contents are not reset. The reset feature is very convenient for estimating the crop yield frequency distribution for a given soil profile. For example, a 20-year simulation gives 20 crop-yield estimates under various weather conditions for a static soil profile. At the other extreme (PEC=10), erosion rates are increased 10 times to improve long-term simulation efficiency. Since PEC is linear in the erosion equations, a 1000-year period can be approximated with a 100-year simulation by using PEC=10. The ACW variable performs a similar function for wind erosion.

ENTRY AND ASSEMBLY SYSTEM FOR EPIC (EASE)

A system called EASE was developed for use in assembling and entering EPIC input data. EASE was designed for user convenience and to reduce input errors. The interactive program prompts the user for inputs, provides a warning when input values are outside a typical range, allows editing, and builds a new file in EPIC-compatible format. Thus, the user is not concerned with input formats and has considerable protection from data entry mistakes.

The EASE program written in FORTRAN 77 consists of a main program and 26 subprograms. The main program writes prompts, reads input, writes data on a new file in EPIC format, and manages the other subprograms.

The prompts and ranges for each of the data items are inputted and stored. The beginning prompts for each section are set in the PI array at the beginning of the program and are used in referencing the prompts in the subroutines. This arrangement provides a general framework that, with slight modification, can be used to build data sets for almost any program.

Table XI.1 contains EASE input data forms filled out with example data from Bell County, TX. The input values are provided to help new users build their first few data sets. Data sources can be explored through use of the example values. Table XI.2 contains the EASE-prepared EPIC data set for the Bell County example.

EPIC OUTPUT

Several output options are available to the EPIC user. The selection of output variables and output intervals was discussed in the Input Data section. Table XII.1 contains the output for the Bell County example. The EPIC output is divided into three major sections: (1) input values and initial conditions, (2) simulation results reported daily, monthly, or annually, and (3) summary tables. The typical

annual output is illustrated in this example. Monthly and daily outputs are illustrated in tables XII.2 and XII.3. Output variable definitions are contained in table IX.1.

EPIC APPLICATIONS

The EPIC model was designed for use in determining the effect of erosion on productivity. However, it can be applied to a variety of problems beyond the E/P analysis, for example,

- As a research tool the model provides a framework for developing and refining individual component models. It identifies knowledge gaps and assists in experimental design.
- As an agricultural management tool, EPIC can be used at the
 - 1) national and regional levels for
 - a) evaluating soil loss tolerance
 - b) estimating drought impact on crop yields
 - c) estimating N leaching potential of various soils in several climatic regions of the United States
 - 2) farm management level to help answer questions about
 - a) drainage
 - b) irrigation
 - c) water yield
 - d) erosion control
 - e) fertilizer and lime application
 - f) pest control
 - g) crop rotations
 - h) planting dates
 - i) tillage and crop residue management
 - j) furrow dike systems

REFERENCES

Chow, Ven Te. 1959. Open-channel hydraulics. McGraw-Hill. pp. 112-113.

Engman, E. T. 1983. Roughness coefficients for routing surface runoff. Proc. ASCE Spec. Conf. Frontiers of Hydraulic Engineering.

Hershfield, D. M. 1961. Rainfall frequency atlas of the United States for durations from 30 minutes to 24 hours and return periods from 1 to 100 years. U.S. Dep. Comm., Tech. Paper No. 40. 115 pp.

Kletke, D. D. 1979. Operation of the enterprise budget generator. Okla. State Univ., Agric. Exp. Stn. Res. Rep. P-790, 129 pp.

Perrins, S. J., G. R. Foster, and D. B. Beasley. 1985. Erosion's effect on productivity along nonuniform slopes. In: Proc. Nat. Symp. Erosion and Soil Productivity. December 1984, New Orleans, pp. 201-204.

U.S. Department of Agriculture, Soil Conservation Service. 1966. Soil survey laboratory data and descriptions for some soils. Soil Survey Invest. Rep. No. 2, 271 pp.

U.S. Department of Agriculture, Soil Conservation Service. 1972. National engineering handbook, hydrology, section 4, Ch. 4-10.

U.S. Department of Commerce. 1968. Climatic atlas of the United States. Environ. Sci. Serv. Admin., Environ. Data Serv. 80 pp.

U.S. Department of Commerce. 1978. Climatological data. National Summary. Annu. Sum. 29, 98 pp.

U.S. Department of Commerce. 1979. Maximum short duration rainfall. National Summary, Climatic Data.

Water Information Center, Inc. 1974. Climate of the States, Vol. 1 Eastern States, Vol. 2 Western States. Port Washington, NY. 479 pp.

Williams, J. R. 1985. The physical components of the EPIC model. In: S. A. El-Swaify, W. C. Moldenhauer, and Andrew Lo, eds., Soil Erosion and Conservation. pp. 272-284. SCSA, Madison. 533 pp.

Williams, J. R., and H. D. Berndt. 1977. Determining the universal soil loss equation's length-slope factor for watersheds. In: G. R. Foster, ed., Soil Erosion: Prediction and Control, Proc. Nat. Soil Erosion Conf., Purdue Univ., pp. 217-225. SCSA Spec. Publ. No. 21, 393 pp.

Williams, J. R., and K. G. Renard. 1985. Assessments of soil erosion and crop productivity with process models (EPIC). In: R. F. Follett and B. A. Stewart, eds., Soil Erosion and Crop Productivity. Amer. Soc. Agron., Crop Sci. Soc. Amer., Soil Sci. Soc. Amer., Madison, WI, pp. 67-103. 533 pp.

Williams, J. R., P. T. Dyke, and C. A. Jones. 1983. EPIC --A model for assessing the effects of erosion on soil productivity. In: W. K. Lauenroth, G. V. Skogerboe, and M. Flug, eds., Analysis of Ecological Systems: State-of-the-Art in Ecological Modeling, Proc. Third Intl. Conf. State-of-the-Art Ecological Modeling, Colorado State Univ., May 1982, pp. 553-572.

Williams, J. R., C. A. Jones, and P. T. Dyke. 1984a. A modeling approach to determining the relationship between erosion and soil productivity. Trans. ASAE 27(1):129-144.

Williams, J. R., C. A. Jones, and P. T. Dyke. 1984b. The EPIC model and its application. In: Proc. Intl. Symp. Minimum Data Sets for Agrotechnology Transfer, ICRISAT Center, India, March 1983, pp. 111-121.

Wischmeier, W. H., and D. D. Smith. 1978. Predicting rainfall erosion losses, A guide to conservation planning. U.S. Dep. Agriculture, Agric. Handb. No. 537. 58 pp.

APPENDIX I: WEATHER

Table I.1.
Weather generation data

Number	Location	TP5	TP6	TP24	JAN	FEB	MAR	APR	MAY	JUN	JUL	AUG	SEP	OCT	NOV	DEC
1	AL BIRMINGHAM	186.00	71.10	152.40												
	Ave. monthly maximum air temp. (°C)	13.06	14.61	18.50	23.28	27.50	31.50	32.33	32.17	30.22	24.89	17.78	13.44			
	Ave. monthly minimum air temp. (°C)	1.61	2.83	5.72	9.89	14.17	18.94	20.56	20.11	17.28	10.33	4.44	1.72			
	Mo. std. dev. max. air temp. (°C)	4.32	4.03	4.18	2.91	2.96	2.94	2.84	3.64	3.14	2.91	3.39	4.04			
	Mo. std. dev. min. air temp. (°C)	5.74	8.02	5.13	3.87	3.81	3.41	2.88	4.45	3.87	3.99	5.94	5.11			
	Average monthly precipitation (mm)	123.7	131.2	152.4	121.2	99.3	99.8	127.4	104.5	95.9	68.1	95.2	136.2			
	Mo. std. dev. of daily prec. (mm)	15.5	17.0	20.1	16.8	15.2	16.3	12.4	15.0	17.3	15.2	12.7	18.0			
	Mo. skew coef. for daily prec. (mm)	2.74	3.37	4.28	2.53	2.68	2.67	3.00	2.62	2.20	2.12	1.68	3.07			
	Mo. probability of wet day/dry day	264	.299	.285	.245	.183	.220	.307	.265	.175	.144	.213	.267			
	Mo. probability of wet day/wet day	491	.505	.475	.444	.530	.481	.548	.426	.480	.395	.497	.495			
	Ave. number days of rain/month (d)	10.59	10.54	10.91	9.18	8.69	8.93	12.54	9.79	7.55	5.96	8.92	10.72			
	Mo. max. 0.5 h rainfall (mm)	26.2	17.8	35.3	21.1	35.6	18.5	27.9	32.8	36.1	19.6	18.3	20.3			
	Mo. ave. daily solar rad. (MJ m ⁻²)	235.	294.	349.	476.	549.	548.	556.	520.	442.	370.	278.	204.			
	Mo. average relative humidity	.78	.70	.75	.75	.75	.73	.73	.75	.73	.71	.75	.74			

Table I.2.
Locations where weather generation data are available

Number	Location	Number	Location
1	AL BIRMINGHAM	68	NC RALEIGH
2	AL MOBILE	69	ND BISMARCK
3	AL MONTGOMERY	70	ND WILLISTON
4	AR FORT SMITH	71	NE GRAND ISLAND
5	AR LITTLE ROCK	72	NE NORTH PLATTE
6	AZ FLAGSTAFF	73	NE SCOTTSBLUFF
7	AZ PHOENIX	74	NH CONCORD
8	AZ YUMA	75	NH MOUNT WASHINGTON
9	CA BAKERSFIELD	76	NJ NEWARK
10	CA BLUE CANYON	77	NM ALBUQUERQUE
11	CA EUREKA	78	NM ROSWELL
12	CA FRESNO	79	NV ELKO
13	CA MT. SIESTA	80	NV LAS VEGAS
14	CA SAN DIEGO	81	NV RENO
15	CA SAN FRANCISCO	82	NV WINNEMUCCA
16	CO COLORADO SPRINGS	83	NY ALBANY
17	CO DENVER	84	NY BUFFALO
18	CO GRAND JUNCTION	85	NY NEW YORK
19	CO PUEBLO	86	NY SYRACUSE
20	CT HARTFORD (WINDSOR)	87	OH CLEVELAND
21	DC WASHINGTON	88	OH COLUMBUS
22	DE WILMINGTON	89	OH TOLEDO
23	FL JACKSONVILLE	90	OK OKLAHOMA CITY
24	FL MIAMI	91	OK TULSA
25	FL TALLAHASSEE	92	OR BURNS
26	FL TAMPA	93	OR MEACHUM
27	GA ATLANTA	94	OR MEDFORD
28	GA AUGUSTA	95	OR PENDLETON
29	GA MACON	96	OR PORTLAND
30	GA SAVANNAH	97	OR SALEM
31	IA DES MOINES	98	OR SEXTON SUMMIT
32	IA DUBUQUE	99	PA PHILADELPHIA
33	ID BOISE	100	PA PITTSBURGH
34	ID POCATELLO	101	RI PROVIDENCE
35	IL CHICAGO	102	SC CHARLESTON
36	IN EVANSVILLE	103	SC COLUMBIA
37	IN FORT WAYNE	104	SD HURON
38	IN INDIANAPOLIS	105	SD RAPID CITY
39	KS DODGE CITY	106	TN CHATTANOOGA
40	KS TOPEKA	107	TN KNOXVILLE
41	KS WICHITA	108	TN MEMPHIS
42	KY LEXINGTON	109	TN NASHVILLE
43	KY LOUISVILLE	110	TX AMARILLO
44	LA BATON ROUGE	111	TX AUSTIN
45	LA NEW ORLEANS	112	TX BROWNSVILLE
46	LA SHREVEPORT	113	TX CORPUS CHRISTI
47	MA BOSTON	114	TX DALLAS
48	MA NANTUCKET	115	TX EL PASO
49	MA PORTLAND	116	TX GALVESTON
50	MD BALTIMORE	117	TX HOUSTON
51	ME CARIBOU	118	TX SAN ANTONIO
52	MI DETROIT	119	TX WACO
53	MI GRAND RAPIDS	120	UT MILFORD
54	MN DULUTH	121	UT SALT LAKE CITY
55	MN MINNEAPOLIS	122	VA NORFOLK
56	MO COLUMBIA	123	VA RICHMOND
57	MO KANSAS CITY	124	WA OLYMPIA
58	MO SAINT LOUIS	125	WA SPOKANE
59	MS JACKSON	126	WA STAMPEDE PASS
60	MT BILLINGS	127	WA WALLA WALLA
61	MT GREAT FALLS	128	WA YAKIMA
62	MT HAVRE	129	WI GREEN BAY
63	MT HELENA	130	WI LA CROSSE
64	MT KALISPELL	131	WI MADISON
65	MT MILES CITY	132	WI MILWAUKEE
66	NC ASHEVILLE	133	WV CHARLESTON
67	NC GREENSBORO	134	WY CHEYENNE

Table I.3.
Wind generation data

LOCATION = AL CULLMAN

	JAN	FEB	MAR	APR	MAY	JUN	JUL	AUG	SEP	OCT	NOV	DEC
Average wind speed (m s^{-1})	4.02	4.47	4.47	4.02	3.58	3.13	2.68	2.68	3.13	3.13	3.58	3.58
Direction	Time (%)											
N	8.0	8.0	8.0	6.0	8.0	6.0	5.0	8.0	10.0	11.0	9.0	8.0
NE	6.0	5.0	6.0	5.0	5.0	5.0	5.0	6.0	8.0	7.0	5.0	5.0
NNE	6.0	7.0	7.0	5.0	6.0	7.0	8.0	10.0	10.0	12.0	8.0	7.0
EN	5.0	6.0	4.0	5.0	5.0	5.0	6.0	6.0	12.0	10.0	6.0	6.0
E	7.0	7.0	7.0	7.0	7.0	9.0	8.0	10.0	10.0	7.0	7.0	7.0
ESE	4.0	7.0	4.0	5.0	5.0	4.0	5.0	5.0	6.0	5.0	5.0	4.0
SE	6.0	4.0	7.0	9.0	7.0	5.0	8.0	7.0	9.0	4.0	6.0	5.0
SSE	5.0	5.0	4.0	6.0	5.0	5.0	5.0	5.0	5.0	1.0	6.0	6.0
S	8.0	4.0	9.0	10.0	9.0	8.0	8.0	7.0	5.0	5.0	7.0	7.0
SSW	7.0	9.0	7.0	8.0	7.0	6.0	6.0	4.0	4.0	4.0	5.0	6.0
WSW	5.0	6.0	6.0	7.0	9.0	12.0	12.0	8.0	4.0	3.0	4.0	6.0
W	5.0	7.0	3.0	4.0	5.0	6.0	5.0	3.0	3.0	3.0	4.0	4.0
WNW	4.0	4.0	7.0	6.0	7.0	8.0	8.0	7.0	3.0	6.0	6.0	6.0
NW	7.0	5.0	7.0	6.0	4.0	4.0	4.0	4.0	3.0	5.0	5.0	6.0
NNW	7.0	6.0	10.0	7.0	6.0	7.0	4.0	6.0	4.0	7.0	10.0	8.0

Table I.4.
Locations where wind generation data are available

Number	Location	Number	Location	Number	Location
1	AL CULLMAN	60	LA DE SOTO	119	OH SUMMIT
2	AL MACON	61	LA LAFOURCHE	120	OK CANADIAN
3	AL SUMTER	62	MA HAMPDEN	121	OK HARMON
4	AR LOGAN	63	MD GARRETT	122	OK OKLAHOMA
5	AR MADISON	64	ME AROSTOOK	123	OR BAKER
6	AR POLK	65	ME CUMBERLAND	124	OR CLACKAMAS
7	AZ COCHISE	66	MI BENZIE	125	OR HARNEY
8	AZ MARICOPA	67	MI CRAWFORD	126	OR TILLAMOOK
9	CA CALAVERAS	68	MI EATON	127	PA FULTON
10	CA CONTRA COSTA	69	MI GOGEBIC	128	PA TIOGA
11	CA EL DORADO	70	MI LUCE	129	SC AIKEN
12	CA FRESNO	71	MI MACOMB	130	SD AURORA
13	CA GLENN	72	MI VAN BUREN	131	SD GRANT
14	CA MENDICINO	73	MN ANOKA	132	SD HYDE
15	CA MODOC	74	MN BELTRAMI	133	SD LAWRENCE
16	CA SANTA CLARA	75	MN HUBBARD	134	SD LYMAN
17	CA SAN DIEGO	76	MO HOWELL	135	SD PENNINGTON
18	CA SAN BERNADINO	77	MO PHELPS	136	SD SHANNON
19	CA SISKIYOU	78	MO PUTNAM	137	SD STANLEY
20	CA VENTURA	79	MS CARROLL	138	TN MARSHALL
21	CA YOLO	80	MS WASHINGTON	139	TN SUMNER
22	CO COSTALLA	81	MT DEER LODGE	140	TX ARANSAS
23	CO EL PASO	82	MT HILL	141	TX ATASCOSA
24	CO MOFFAT	83	MT MUSSELSHELL	142	TX BELL
25	CO OTERO	84	MT ROOSEVELT	143	TX BOSQUE
26	CO SAGUACHE	85	MT STILLWATER	144	TX BURLESON
27	CO WASHINGTON	86	NC ALAMANCE	145	TX CASTRO
28	CT TOLLAND	87	NC BUNCOMBE	146	TX FT BEND
29	DE SUSSEX	88	NC CRAVEN	147	TX HIDALGO
30	FL MARION	89	NC HALIFAX	148	TX HUDSPETH
31	FL OSCEOLA	90	NC TYRELL	149	TX JIM WELLS
32	FL PALM BEACH	91	ND BURLEIGH	150	TX KAUFMAN
33	FL ST LUCIE	92	ND CARROLL	151	TX KIMBLE
34	FL SUWANNEE	93	ND HETTINGER	152	TX LLANO
35	FL WAKULLA	94	ND LA MOURE	153	TX PARKER
36	GA CATOOSA	95	ND PIERCE	154	TX STEPHENS
37	GA CHATHAM	96	ND TRAILL	155	TX WEBB
38	GA WALTON	97	NE CEDAR	156	UT KANE
39	IA BREMER	98	NE CHERRY	157	UT TOOELE
40	IA KOSSUTH	99	NE PAWNEE	158	UT WASATCH
41	IA MONTGOMERY	100	NE SHERMAN	159	VA GILES
42	ID LINCOLN	101	NH COOS	160	WA CHELAN
43	ID MADISON	102	NJ GLOUSCESTER	161	WA FRANKLIN
44	IL IROQUOIS	103	NM CATRON	162	WA POMEROY
45	IL JACKSON	104	NM GUADALUPE	163	WA SPOKANE
46	IL MARION	105	NM MCKINLEY	164	WA THURSTON
47	IL MCDONOUGH	106	NM SAN JUAN	165	WA WALLA WALLA
48	IN JACKSON	107	NV CHURCHILL	166	WA WHITMAN
49	KA CHASE	108	NV DOUGLAS	167	WI BARRON
50	KA CHEROKEE	109	NV ELKO	168	WI BAYFIELD
51	KA CLAY	110	NV EUREKA	169	WI JEFFERSON
52	KA OTTAWA	111	NV HUMBOLDT	170	WI OCONTO
53	KA ROOKS	112	NV LINCOLN	171	WI VERNON
54	KA STAFFORD	113	NY CAYUGA	172	WV TYLER
55	KA THOMAS	114	NY ST LAWRENCE	173	WY CAMPBELL
56	KY DAVIESS	115	NY SUFFOLK	174	WY WASHAKIE
57	KY KNOX	116	OH ERIE		
58	KY SCOTT	117	OH MERCER		
59	LA BEAUREGARD	118	OH PERRY		

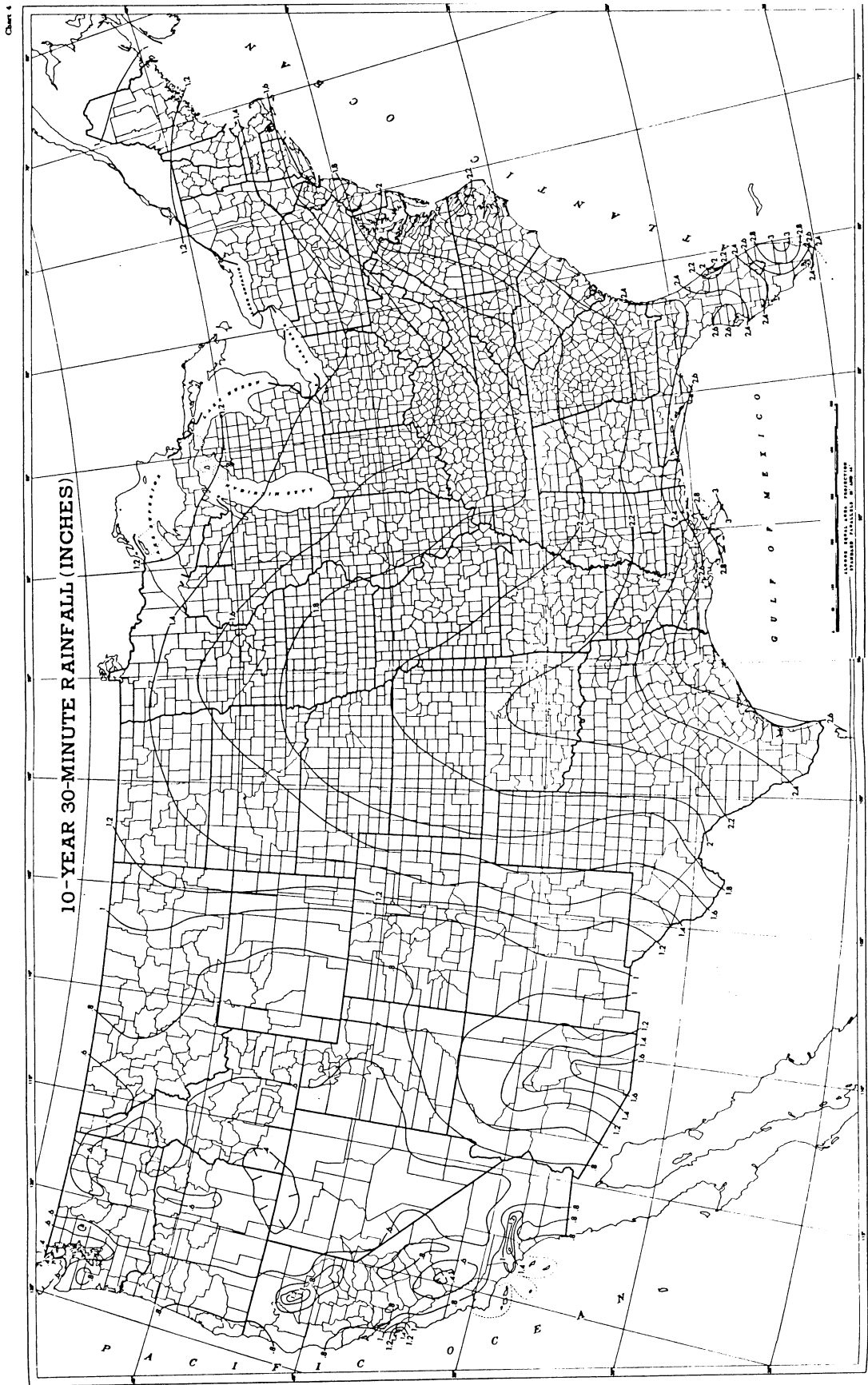

Figure I.1.
10-year 30-minute rainfall (inches). Taken from TP-40 (Hershfield 1961). 1 inch = 25.4 mm.

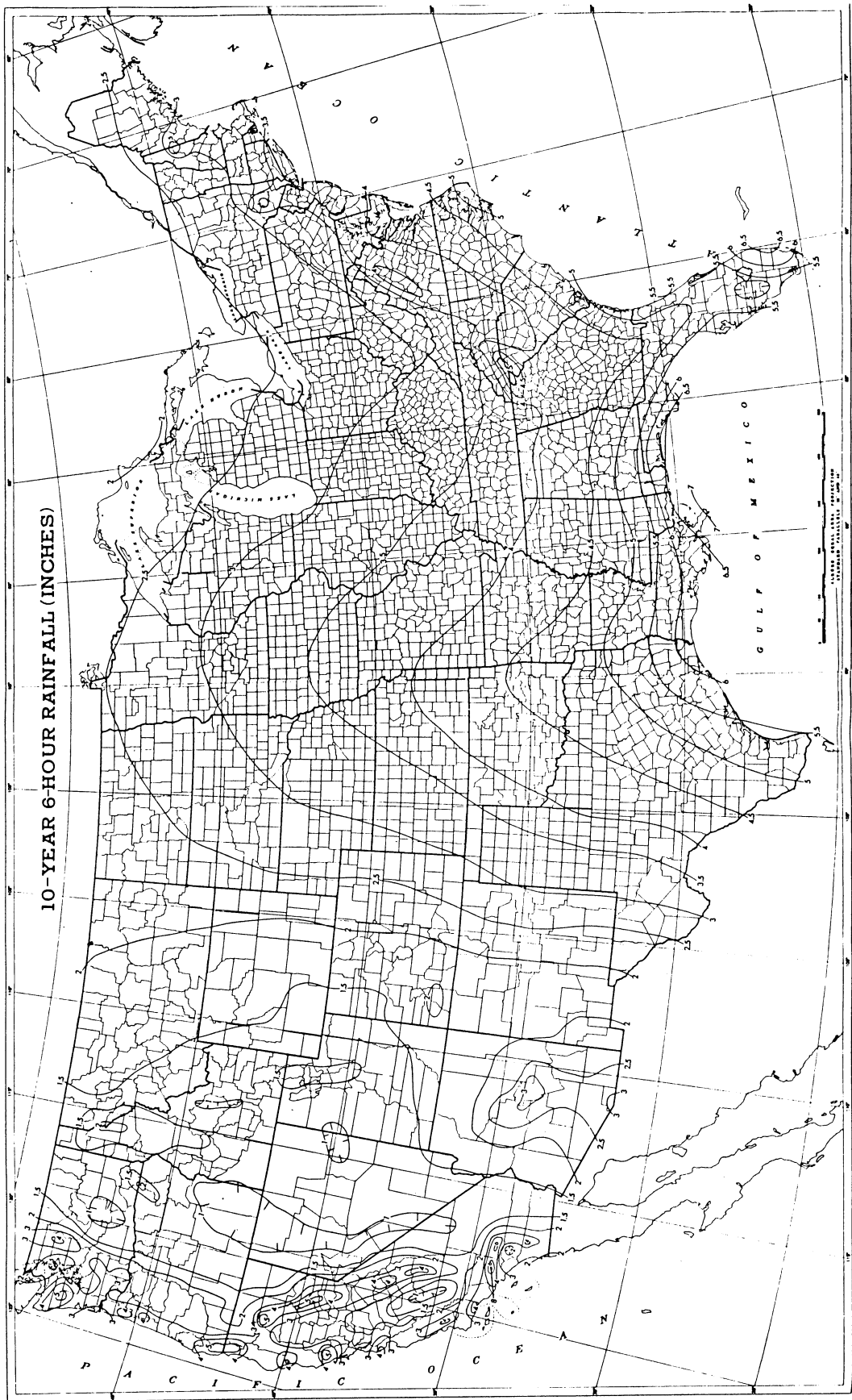

Figure I.2.
10 year 6-hour rainfall (inches). Taken from TP-40 (Hershfield 1961). 1 inch = 25.4 mm.

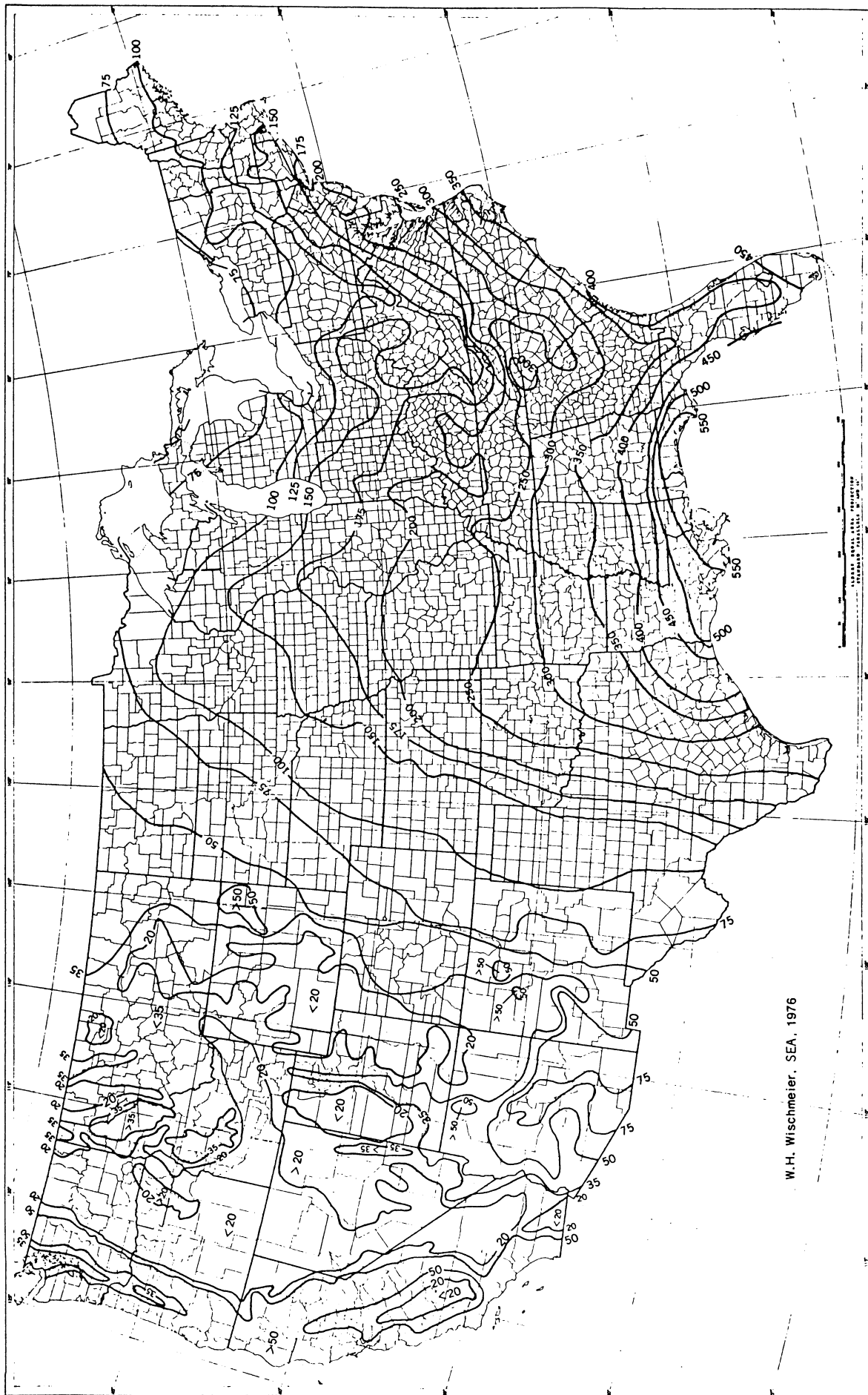

Figure I.3. Average annual values of the rainfall erosion index (EI). Map values must be multiplied by 1.735 to obtain metric EI. Taken from Wischmeier and Smith (1978).

APPENDIX II: HYDROLOGY

Table II.1.a.
Runoff curve numbers for hydrologic soil-cover complexes
(Antecedent moisture condition II, and $I_a = 0.2 S$)

Land use	Cover		Hydrologic soil group			
	Treatment or practice	Hydrologic condition	A	B	C	D
Fallow	Straight row	----	77	86	91	94
Row crops	Straight row	Poor	72	81	88	91
	"	Good	67	78	85	89
	Contoured	Poor	70	79	84	88
	"	Good	65	65	82	86
	Contoured and terraced	Poor	66	74	80	82
	"	Good	62	71	78	81
Small grain	Straight row	Poor	65	76	84	88
	"	Good	63	75	83	87
	Contoured	Poor	63	74	82	85
	"	Good	61	73	81	84
	Contoured and terraced	Poor	61	72	79	82
	"	Good	59	70	78	81
Close-seeded legumes ¹ or rotation meadow	Straight row	Poor	66	77	85	89
	"	Good	58	72	81	85
	Contoured	Poor	64	75	83	85
	"	Good	55	69	78	83
	Contoured and terraced	Poor	63	73	80	83
	"	Good	51	67	76	80
Pasture or range		Poor	68	79	86	89
		Fair	49	69	79	84
		Good	39	61	74	80
	Contoured	Poor	47	67	81	88
	"	Fair	25	59	75	83
	"	Good	6	35	70	79
Meadow		Good	30	58	71	78
Woods		Poor	45	66	77	83
		Fair	36	60	73	79
		Good	25	55	70	77
Farmsteads		----	59	74	82	86
Roads (dirt) ² (hard surface) ²		----	72	82	87	89
		----	74	84	90	92

¹ Close-drilled or broadcast.

² Including right-of-way.

Taken from the National Engineering Handbook
(U.S. Department of Agriculture, Soil Conservation Service 1972).

Table II.1.b.

Runoff curve numbers for hydrologic soil-cover complexes in
Puerto Rico (Antecedent moisture condition II, and $I_a = 0.2 S$)

Cover and condition	Hydrologic soil group			
	A	B	C	D
Fallow	77	86	91	93
Grass (bunch grass or poor stand of sod)	51	70	80	84
Coffee (no ground cover, no terraces)	48	68	79	83
Coffee (with ground cover and terraces)	22	52	68	75
Minor crops (garden or truck crops)	45	66	77	83
Tropical kudzu	19	50	67	74
Sugarcane (trash burned; straight row)	43	65	77	82
Sugarcane (trash mulch; straight row)	45	66	77	83
Sugarcane (in holes; on contour)	24	53	69	76
Sugarcane (in furrows; on contour)	32	58	72	79

Table II.1.c.

Runoff curve numbers for hydrologic soil-cover complexes of
a typical watershed in Contra Costa County, California
(Antecedent moisture condition II, and $I_a = 0.2 S$)

Cover	Condition	Hydrologic soil group			
		A	B	C	D
Scrub (native brush)	----	25-30	41-46	57-63	66
Grass-oak (native oaks with understory of forbs and annual grasses)	Good	29-33	43-48	59-65	67
Irrigated pasture	Good	32-37	46-51	62-68	70
Orchard (winter period with understory of cover crop)	Good	37-41	50-55	64-69	71
Range (annual grass)	Fair	46-49	57-60	68-72	74
Small grain (contoured)	Good	61-64	69-71	76-80	81
Truck crops (straight row)	Good	67-69	74-76	80-83	84
Urban areas:					
Low density (15 to 18 percent impervious surfaces)		69-71	75-78	82-84	86
Medium density (21 to 27 percent impervious surfaces)		71-73	77-80	84-86	88
High density (50 to 75 percent impervious surfaces)		73-75	79-82	86-88	90

Table II.1.d.

Runoff curve numbers; tentative estimates for sugarcane hydrology soil-cover complexes in Hawaii (Antecedent moisture condition II, and $I_a = 0.2 S$)

Cover and treatment	Hydrologic soil group			
	A	B	C	D
Sugarcane: Limited cover, straight row	67	78	85	89
Partial cover, straight row	49	69	79	84
Complete cover, straight row	39	61	74	80
Limited cover, contoured	65	75	82	86
Partial cover, contoured	25	59	75	83
Complete cover, contoured	6	35	70	79

Limited cover--Cane newly planted, or ratooned cane with a limited root system; canopy over less than 1/2 the field area.

Partial cover--Cane in the transition period between limited and complete cover; canopy over 1/2 to nearly the entire field area.

Complete cover--Cane from the stage of growth when full canopy is provided to the stage at harvest.

Straight row planting is up and down hill or cross-slope on slopes greater than 2 percent. Contoured planting is the usual contouring or cross-slope planting on slopes less than 2 percent.

Table II.2.

Values of Manning's roughness factor n

	Value chosen	Range
I. Channel flow ¹		
A. Excavated or dredged		
1. Earth, straight and uniform	0.025	0.016-0.033
2. Earth, winding and sluggish	0.035	0.023-0.05
3. Not maintained, weeds and brush	0.075	0.04-0.14
B. Natural streams		
1. Few trees, stones, or brush	0.05	0.025-0.065
2. Heavy timber and brush	0.10	0.05-0.15
II. Overland flow ²		
Fallow, no residue	0.01	0.008-0.012
Conventional tillage, no residue	0.09	0.06-0.12
Conventional tillage, residue	0.19	0.16-0.22
Chisel plow, no residue	0.09	0.06-0.12
Chisel plow, residue	0.13	0.10-0.16
Fall disking, residue	0.40	0.30-0.50
No till, no residue	0.07	0.04-0.10
No till (0.5 - 1 t/ha ¹)	0.12	0.07-0.17
No till (2 - 9 t/ha ¹)	0.30	0.17-0.47
Rangeland (20% cover)	0.60	
Short grass prairie	0.15	0.10-0.20
Dense grass	0.24	0.17-0.30
Bermudagrass	0.41	0.30-0.48

¹ Taken from Chow (1959)

² Taken from Engman (1983)

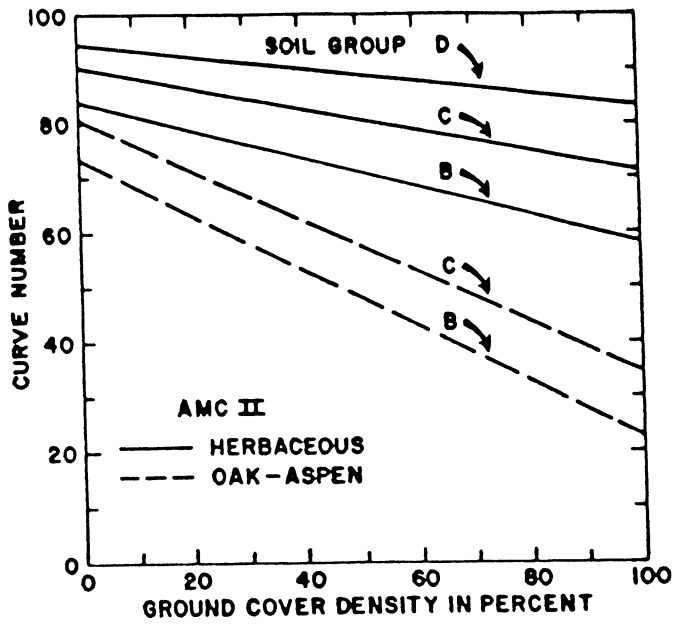

Figure II.1.
Graph for estimating runoff curve numbers of forest-range complexes in Western United States: herbaceous and oak-aspen complexes.

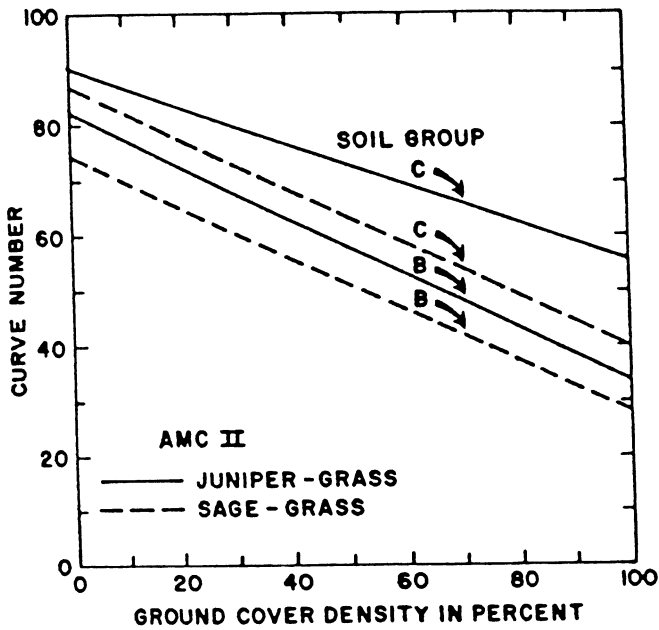

Figure II.2
Graph for estimating runoff curve numbers of forest-range complexes in Western United States: juniper-grass and sage-grass complexes.

APPENDIX III: CROP DATA

Table III.1.
EPIC crop parameters

	1	2	3	4	5	6	7	8	9	10	11
(1)	SOYB	CORN	GRSG	WWHT	SWHT	DWHT	BARL	OATS	SUNF	COTS	COTP
WA(2)	25.0000	40.0000	35.0000	35.0000	35.0000	25.0000	35.0000	35.0000	60.0000	17.5000	20.0000
HI	.3100	.5000	.5000	.4200	.4200	.3000	.4200	.4200	.2500	.5000	.5000
TB	25.0000	25.0000	27.5000	15.0000	15.0000	15.0000	15.0000	15.0000	25.0000	27.5000	27.5000
TG	10.0000	8.0000	10.0000	.0000	.0000	.0000	.0000	.0000	6.0000	12.0000	12.0000
DMLA	5.0000	5.0000	5.0000	8.0000	9.0000	9.0000	8.0000	8.0000	5.0000	5.0000	5.0000
DLAI	.9000	.8000	.8000	.8000	.8000	.8000	.8000	.8000	.5500	.8500	.8500
DLP1	15.0100	15.0500	15.0500	15.0100	15.0100	15.0100	15.0100	15.0100	15.0100	15.0100	15.0100
DLP2	50.9500	50.9500	50.9500	50.9500	50.9500	50.9500	50.9500	50.9500	50.9500	50.9500	50.9500
RLAD	2.0000	1.0000	.5000	1.0000	2.0000	2.0000	1.0000	1.0000	1.0000	2.0000	2.0000
RBMD	10.0000	1.0000	2.0000	10.0000	10.0000	10.0000	2.0000	2.0000	2.0000	2.0000	10.0000
ALT	3.0000	3.0000	2.0000	2.0000	2.0000	2.0000	2.0000	2.0000	3.0000	3.0000	3.0000
CPF	.0000	.0000	.0000	.0000	.0000	.0000	.0000	.0000	.0000	.0000	.0000
CAF	.8500	.8500	.8500	.8500	.8500	.8500	.8500	.8500	.8500	.8500	.8500
SDW	35.0000	20.0000	5.0000	90.0000	90.0000	90.0000	90.0000	90.0000	8.0000	30.0000	30.0000
HMX	1.5000	2.5000	1.5000	1.2000	1.2000	1.2000	1.2000	1.2000	2.5000	1.0000	2.0000
RDMX	2.0000	2.0000	2.0000	2.0000	2.0000	2.0000	2.0000	2.0000	2.0000	2.0000	2.0000
PVAR	.0000	.0000	.0000	.0000	.0000	.0000	.0000	.0000	.0000	.0000	.0000
CVM	.2000	.2000	.2000	.0300	.0300	.0500	.0100	.0300	.2000	.2000	.2000
CNY	.0650	.0175	.0200	.0234	.0234	.0209	.0234	.0234	.0280	.0330	.0330
CPY	.0091	.0025	.0028	.0033	.0033	.0050	.0033	.0033	.0061	.0046	.0046
WSYF	.0100	.0500	.0100	.0100	.0100	.0100	.0100	.0100	.0100	.0100	.0100
PST	.9500	.9500	.9500	.9500	.9500	.9500	.9500	.9500	.9500	.9500	.9500
COSD	.3300	2.5100	1.5400	.1800	.1800	.1800	.1800	.3100	3.4200	.8800	.8800
PRY	370.0000	100.0000	96.0000	120.0000	120.0000	120.0000	120.0000	140.0000	190.0000	1100.0000	1100.0000
WCY	.1300	.1500	.1400	.1200	.1200	.0000	.1200	.1000	.0000	.0100	.0100
BN1	.0524	.0440	.0440	.0600	.0600	.0600	.0600	.0600	.0500	.0580	.0580
BN2	.0265	.0164	.0164	.0231	.0231	.0231	.0231	.0231	.0230	.0192	.0192
BN3	.0258	.0128	.0128	.0134	.0128	.0128	.0134	.0134	.0146	.0177	.0177
BP1	.0074	.0062	.0060	.0084	.0084	.0084	.0084	.0084	.0063	.0081	.0081
BP2	.0037	.0023	.0022	.0032	.0032	.0032	.0032	.0032	.0029	.0027	.0027
BP3	.0035	.0018	.0018	.0019	.0019	.0019	.0019	.0019	.0023	.0025	.0025
BW1	1.2660	.4330	.6570	3.3900	3.3900	3.3900	3.3900	3.3900	3.3900	1.1380	1.1380
BW2	.6330	.4330	.6570	3.3900	3.3900	3.3900	3.3900	3.3900	3.3900	.6030	.6030
BW3	.7290	.2130	.3200	1.6100	1.6100	1.6100	1.6100	1.6100	1.6100	.3320	.3220
IDC	1.0000	4.0000	4.0000	5.0000	5.0000	5.0000	5.0000	5.0000	4.0000	4.0000	4.0000
FRS1	5.0100	5.0100	5.0100	5.0100	5.0100	5.0100	5.0100	5.0100	5.1500	5.0100	5.0100
FRS2	15.0500	15.0500	15.0500	15.1000	15.1000	15.1000	15.1000	15.1000	15.9500	15.0500	15.9500

	12	13	14	15	16	18	19	20	21	22	23
(1)	PNUT	RICE	POTA	WPEA	LEN1	SGHY	ALFA	RNGE	SPAS	WPAS	PINE
WA(2)	20.0000	20.0000	15.0000	20.0000	25.0000	35.0000	20.0000	30.0000	30.0000	35.0000	16.5000
HI	.4200	.5000	1.1200	.5500	.5400	.5000	.2500	.2500	.9000	.4200	.7600
TB	25.0000	25.0000	18.0000	14.0000	14.0000	25.0000	20.0000	25.0000	25.0000	15.0000	20.0000
TG	13.5000	10.0000	3.0000	1.0000	1.0000	8.0000	4.0000	8.0000	8.0000	.0000	2.0000
DMLA	5.0000	6.5000	5.0000	9.0000	2.5000	5.0000	5.0000	5.0000	5.0000	8.0000	5.0000
DLAI	.7500	.7800	.6000	.9000	.9000	.8500	.9000	.8500	.8500	.8000	.1500
DLP1	15.0100	30.0100	15.0100	15.0200	15.0200	15.0100	15.0100	15.0100	15.0100	15.0100	10.5000
DLP2	50.9500	70.9500	50.9500	50.9500	50.9500	50.9500	50.9500	50.9500	50.9500	50.9500	25.9900
RLAD	.5000	.5000	2.0000	1.0000	1.0000	2.0000	2.0000	2.0000	2.0000	1.0000	.5000
RBMD	.5000	.5000	10.0000	.5000	.5000	10.0000	10.0000	10.0000	10.0000	10.0000	1.0000
ALT	4.0000	3.0000	3.0000	2.0000	3.0000	2.0000	3.0000	4.0000	4.0000	2.0000	1.0000
CPF	.0000	.0000	.0000	.0000	.0000	.0000	.0000	.0000	.0000	.0000	22.5000
CAF	.8500	10.0000	5.0000	.8500	.9000	.8500	.8500	.8500	.8500	.8500	.7700
SDW	30.0000	50.0000	200.0000	140.0000	100.0000	90.0000	15.0000	5.0000	5.0000	90.0000	80.0000
HMX	2.0000	.8000	.8000	1.0000	.5500	2.0000	1.2500	1.5000	1.5000	1.2000	20.0000
RDMX	2.0000	.9000	2.0000	2.0000	2.0000	2.0000	2.0000	2.0000	2.0000	2.0000	2.0000
PVAR	.0000	.0000	.0000	.0000	.0000	.0000	.0000	.0000	.0000	.0000	.0000
CVM	.2000	.5000	.0500	.0500	.2000	.1000	.0100	.0050	.0030	.0300	.0010
CNY	.0650	.0130	.0140	.0380	.0400	.0200	.0250	.0234	.0234	.0234	.0015
CPY	.0091	.0050	.0014	.0050	.0050	.0028	.0035	.0033	.0033	.0033	.0003
WSYF	.0100	.0000	.0100	.0100	.0100	.0100	.0100	.0100	.0100	.0100	.0000
PST	.9000	.9500	.9500	.9500	.9000	.9500	.9500	.9500	.9500	.9500	.9500
COSD	1.5400	.1000	.1000	.3100	10.0000	.1540	5.0700	.3100	.3100	.1800	3.0000
PRY	600.0000	50.0000	50.0000	24.0000	100.0000	96.6000	77.0000	20.0000	20.0000	120.0000	1000.0000
WCY	.0600	.1400	.8000	.1200	.1200	.1400	.1000	.1000	.1000	.1200	.0000
BN1	.0524	.0500	.0600	.0400	.0524	.0440	.0500	.0600	.0600	.0600	.0060
BN2	.0265	.0200	.0250	.0260	.0320	.0164	.0300	.0231	.0231	.0231	.0020
BN3	.0258	.0100	.0120	.0232	.0286	.0128	.0200	.0134	.0134	.0134	.0015
BP1	.0074	.0060	.0060	.0070	.0074	.0060	.0071	.0084	.0084	.0084	.0007
BP2	.0037	.0030	.0025	.0040	.0037	.0022	.0042	.0032	.0032	.0032	.0004
BP3	.0035	.0018	.0012	.0030	.0035	.0018	.0028	.0019	.0019	.0019	.0003
BW1	1.2660	3.3900	3.3900	3.3900	1.2660	3.3900	3.3900	3.3900	3.3900	3.3900	3.3900
BW2	.6330	3.3900	3.3900	3.3900	.6330	3.3900	3.3900	3.3900	3.3900	3.3900	3.3900
BW3	.7290	.3200	.3200	3.3900	.7290	.3200	3.3900	3.3900	3.3900	1.6100	3.9000
IDC	1.0000	4.0000	5.0000	2.0000	2.0000	4.0000	3.0000	6.0000	6.0000	5.0000	7.0000
FRS1	5.0500	5.0100	5.0100	5.0500	5.0500	5.0100	5.0100	5.0100	5.0100	5.0100	5.0010
FRS2	15.9500	15.9500	15.9500	15.1000	15.1000	15.9500	15.9500	15.9500	15.9500	15.1000	15.0020

Table III.1.--Continued.
EPIC crop parameters

(1) Abbreviated crop names:

SOYB	= soybeans	PNUT	= peanuts
CORN	= corn	RICE	= rice
GRSG	= grain sorghum	POTA	= potato
WWHT	= winter wheat	WPEA	= winter peas
SWHT	= spring wheat	LEN1	= lentles
DWHT	= durham wheat	SGHY	= sorghum hay
BARL	= barley	ALFA	= alfalfa
OATS	= oats	RNGE	= range
SUNF	= sunflower	SPAS	= spring pasture
COTS	= stripper cotton	WPAS	= winter pasture
COTP	= picker cotton	PINE	= pine trees

(2) See table VII.5 for definition of variables.

APPENDIX IV: SOILS

Table IV.1.
Example soil from list in table IV.2

Number	Series name	Albedo	Erodibility factors		Runoff curve number		Soil5 code		
			Water	Wind	Row crop	Small grain			
1	ABBOTT	120	280	193.	89.	87.	UT129		
Soil depth (m)		.010	.150	.200	.560	.790	1.020	1.370	1.770
Bulk density (t m ⁻³)		1.20	1.20	1.20	1.20	1.20	1.20	1.20	1.20
Wilting point (m m ⁻¹)		.257	.257	.257	.258	.269	.269	.269	.269
Field capacity (m m ⁻¹)		.415	.415	.415	.428	.441	.441	.444	.445
Sand content (%)		5.0	5.0	5.0	5.0	5.0	5.0	5.0	5.0
Silt content (%)		47.5	47.5	47.5	47.5	45.0	45.0	45.0	45.0
Organic N concentration (g t ⁻¹)		1430.	1430.	1430.	600.	410.	410.	260.	210.
Soil pH		8.1	8.1	8.1	8.0	7.8	7.8	8.0	8.0
Sum of bases (cmol kg ⁻¹)		29.7	29.7	29.7	30.9	30.9	36.8	21.8	19.6
Organic carbon (%)		1.43	1.43	1.43	.60	.41	.41	.26	.21
Calcium carbonate (%)		31.00	31.00	31.00	32.00	34.00	26.00	29.00	35.00
Cation exchange capacity (cmol kg ⁻¹)		29.7	29.7	29.7	30.9	30.9	36.8	21.8	19.6
Coarse fragment content (%)		.0	.0	.0	.0	.0	.0	.0	.0
Nitrate concentration (g t ⁻¹)		10.	10.	5.	5.	5.	5.	5.	5.
Labile P concentration (g t ⁻¹)		30.	30.	10.	10.	10.	10.	10.	10.
Crop residue (t ha ⁻¹)		.034	.434	.398	.525	.192	.016	.001	.001
Bulk density (oven dry) (t m ⁻³)		1.28	1.28	1.28	1.28	1.28	1.28	1.28	1.28
Phosphorus sorption ratio		.00	.00	.00	.00	.00	.00	.00	.00
Saturated conductivity (mm h ⁻¹)		.00	.00	.00	.00	.00	.00	.00	.00
Subsurface flow travel time (d)		0.	0.	0.	0.	0.	0.	0.	0.
Organic P concentration (g t ⁻¹)		0.	0.	0.	0.	0.	0.	0.	0.

Table IV.2.
Soils with table IV.1 data available

NUMBER	SERIES NAME	ALBEDO	ERODIBILITY FACTORS		RUNOFF CURVE NUMBER		SOILS CODE
			---WATER---	---WIND---	ROW CROP-	SMALL GRAIN-	
1	ABBOTT	.120	.280	193.	89.	87.	UT129
2	ABSTON	.130	.240	193.	85.	83.	WY529
3	ACUFF	.130	.280	125.	78.	75.	TX128
4	ADAIR	.130	.320	108.	85.	83.	IA133
5	AGAR-A	.130	.320	108.	78.	75.	SD 70
6	AGAR-B	.130	.320	108.	78.	75.	SD 70
7	AGASSIZ	.140	.200	108.	89.	87.	UT 43
8	AIKEN	.110	.200	108.	78.	75.	CA184
9	ALASTRA	.080	.200	193.	78.	75.	0
10	ALFORD	.140	.370	125.	78.	75.	IN 50
11	ALICEL	.130	.240	125.	78.	75.	OR448
12	ALLEGHENY	.140	.320	125.	67.	63.	KY 99
13	ALLIANCE	.130	.320	125.	78.	75.	NE 2
14	ALMENA	.130	.370	125.	85.	83.	WI262
15	ALSTAD	.130	.240	193.	85.	83.	WI218
16	ALTAMONT	.130	.240	193.	89.	87.	CA 2
17	ALTDORF	.130	.370	125.	89.	87.	WI 31
18	ALVIN	.170	.240	193.	78.	75.	IL 90
19	AMARILLO	.150	.240	193.	78.	75.	TX130
20	AMOR	.130	.280	193.	78.	75.	ND 93
21	ANSELMO	.130	.200	125.	78.	75.	NE 3
22	ANTHONY	.170	.240	193.	78.	75.	AZ141
23	ANTIGO	.130	.370	125.	78.	75.	WI142
24	ANTOSA	.190	.200	695.	89.	87.	TX921
25	APPLING	.150	.240	193.	78.	75.	NC 32
26	APRON	.150	.200	193.	78.	75.	WY 1
27	ARCHABAL	.130	.240	108.	78.	75.	ID289
28	ARCHER-A	.160	.150	695.	85.	83.	FL372
29	ARCHER-B	.160	.150	695.	85.	83.	FL372
30	ARMAGH	.130	.240	85.	89.	87.	PA 94
31	ARMOUR	.140	.430	125.	78.	75.	TN 59
32	ARNEGARD	.130	.280	125.	78.	75.	ND 51
33	ARRINGTON	.130	.370	108.	78.	75.	TN 61
34	ARROYADA	.130	.320	193.	89.	87.	TX852
35	ASCALON	.160	.150	300.	78.	75.	CO 3
36	ASOTIN	.140	.370	125.	85.	83.	WA 35
37	ASTATULA	.130	.100	695.	67.	63.	FL 19
38	ASTORIA	.110	.240	125.	78.	75.	OR295
39	ATHENA	.130	.320	193.	78.	75.	OR 2
40	AUBERRY	.160	.280	193.	78.	75.	CA544
41	AURA	.130	.430	193.	78.	75.	NJ 17
42	AVA	.140	.430	108.	85.	83.	IL 57
43	AVONBURG	.160	.430	125.	89.	87.	IN 40
44	AXTELL	.150	.430	193.	89.	87.	TX328
45	BACA-A	.130	.240	125.	85.	83.	CO 4
46	BACA-B	.150	.240	193.	85.	83.	CO 4
47	BADO	.150	.430	108.	89.	87.	MO 68
48	BAGDAD	.150	.430	125.	78.	75.	WA411
49	BALDOCK	.150	.370	193.	89.	87.	ID142
50	BALMORHEA	.150	.280	193.	85.	83.	TX150
51	BANGO	.130	.200	193.	78.	75.	NV524
52	BARELA	.160	.430	125.	85.	83.	NM127
53	BARNES-A	.130	.280	193.	78.	75.	ND119
54	BARNES-B	.130	.280	193.	78.	75.	ND119
55	BASSEL	.160	.170	193.	78.	75.	CO220
56	BAUDETTE	.130	.370	125.	78.	75.	MN114
57	BAXTER	.130	.280	125.	78.	75.	KY 46
58	BEAR PRAIRIE	.080	.280	193.	78.	75.	WA612
59	BEARDEN	.130	.280	193.	85.	83.	ND 8
60	BEAUMONT	.130	.320	193.	89.	87.	TX 22
61	BECKET	.130	.200	193.	85.	83.	NH 1
62	BEDINGTON	.140	.320	108.	78.	75.	PA 71
63	BELFIELD	.130	.320	108.	85.	83.	ND 79
64	BELFORE	.130	.320	85.	78.	75.	NE 7
65	BELTRAMI	.130	.240	193.	78.	75.	MN136
66	BEOSKA	.140	.550	125.	78.	75.	NV230
67	BERKS-A	.130	.170	108.	85.	83.	PA 4
68	BERKS-B	.130	.170	125.	85.	83.	PA 4
69	BERKSHIRE	.160	.200	193.	85.	83.	MA 29
70	BERNARDSTON	.130	.280	193.	85.	83.	MA 9
71	BETHANY	.140	.430	125.	85.	83.	OK 59
72	BEULAH	.150	.200	300.	78.	75.	AR 70
73	BINGHAM	.140	.240	193.	85.	83.	UT324
74	BLANKET	.150	.320	108.	85.	83.	TX163
75	BLANTON	.130	.100	695.	67.	63.	FL 39
76	BLOOMFIELD	.190	.150	695.	67.	63.	IL165
77	BLUEHILL	.150	.550	193.	85.	83.	ID559
78	BLUEPOINT	.180	.150	695.	67.	63.	NV 11
79	BLUFORD	.140	.430	108.	85.	83.	IL 3
80	BODINE	.140	.280	193.	78.	75.	TN 64
81	BOGART	.130	.320	125.	78.	75.	OH 56
82	BONN	.170	.550	193.	89.	87.	LA 4
83	BONNER	.150	.150	125.	78.	75.	ID232
84	BONNICK	.160	.100	695.	67.	63.	OR376
85	BONTI	.150	.370	193.	85.	83.	TX160
86	BOSKET	.150	.240	193.	78.	75.	AR 44
87	BOSQUE	.130	.280	193.	78.	75.	TX201
88	BOWBAC	.130	.370	193.	85.	83.	MT437
89	BOWDOIN	.150	.370	193.	89.	87.	MT 5
90	BOWIE-A	.150	.320	193.	78.	75.	TX327

Table IV.2.--Continued.
Soils with table IV.1 data available

NUMBER	SERIES NAME	ALBEDO	ERODIBILITY FACTORS		RUNOFF CURVE NUMBER		SOILS CODE
			---WATER---	---WIND---	-ROW CROP-	-SMALL GRAIN-	
91	BOWIE-B	.180	.320	695.	78.	75.	TX327
92	BRACKETT	.180	.320	193.	85.	83.	TX145
93	BRENNAN	.150	.240	193.	78.	75.	TX235
94	BRESSER	.130	.170	193.	78.	75.	CO 9
95	BRITWATER	.150	.370	125.	78.	75.	AR 32
96	BROLLIAR	.130	.240	108.	89.	87.	AZ108
97	BROWNFIELD	.190	.170	695.	67.	63.	TX118
98	BROWNLEE	.130	.200	193.	78.	75.	ID104
99	BRUNDAGE	.150	.370	193.	89.	87.	TX382
100	BUCHANAN	.150	.240	125.	85.	83.	PA 38
101	BUSE-A	.130	.280	193.	78.	75.	MN142
102	BUSE-B	.130	.280	193.	78.	75.	MN317
103	CAJON	.130	.150	695.	67.	63.	CA289
104	CALAWAH	.080	.280	125.	78.	75.	WA600
105	CALIMUS	.130	.240	193.	78.	75.	OR135
106	CALLOWAY	.140	.490	193.	85.	83.	MS 56
107	CALPINE	.130	.170	193.	78.	75.	CA206
108	CAMBERN	.130	.200	193.	85.	83.	AZ181
109	CAMPO	.160	.370	108.	85.	83.	CO 10
110	CANDLER	.130	.100	695.	67.	63.	FL 3
111	CANFIELD	.140	.370	125.	85.	83.	OH 57
112	CANYON	.150	.240	193.	89.	87.	NE 19
113	CAPERTON	.160	.150	193.	89.	87.	CA285
114	CARALAMPI	.150	.150	0.	78.	75.	AZ 61
115	CARNASAW	.130	.370	125.	85.	83.	OK133
116	CARRIZO	.150	.100	695.	67.	63.	CA107
117	CARSON	.120	.240	193.	89.	87.	NV637
118	CARVER-A	.130	.100	695.	67.	63.	MA 40
119	CARVER-B	.130	.100	695.	67.	63.	MA 40
120	CARWILE	.130	.370	125.	89.	87.	OK134
121	CASS	.150	.200	193.	78.	75.	NE118
122	CATHRO	.080	.000	300.	67.	63.	MI 31
123	CATTCREEK	.110	.100	300.	78.	75.	WA138
124	CAVO	.130	.320	108.	89.	87.	SD 179
125	CAVODE	.130	.370	125.	85.	83.	PA 78
126	CECIL	.160	.280	193.	78.	75.	NC 18
127	CHASTAIN	.130	.280	193.	89.	87.	SC 35
128	CHAUMONT	.110	.490	193.	89.	87.	NY247
129	CHENANGO	.130	.320	193.	67.	63.	NY 89
130	CHENOWETH	.130	.490	193.	78.	75.	OR 19
131	CHESHIRE	.130	.240	193.	78.	75.	CT 5
132	CHEWACLA	.130	.240	193.	85.	83.	NC 55
133	CHILCOTT	.140	.490	125.	85.	83.	ID146
134	CHILI	.130	.240	125.	78.	75.	OH 93
135	CINEBAR	.110	.280	125.	78.	75.	WA 62
136	CISNE	.140	.370	108.	89.	87.	IL126
137	CITADEL	.130	.370	193.	85.	83.	SD 123
138	CLARION	.130	.280	108.	78.	75.	IA 74
139	CLARKSVILLE	.140	.280	0.	78.	75.	MO 25
140	CLARNO	.150	.200	193.	78.	75.	SD 21
141	CLICK	.130	.150	193.	67.	63.	TX 32
142	CLIME	.130	.280	193.	85.	83.	KS 23
143	CLINTON	.140	.370	108.	78.	75.	IA116
144	CLYDE	.110	.280	85.	78.	75.	IA 46
145	COCOLALLA-A	.110	.370	108.	89.	87.	WA304
146	COCOLALLA-B	.110	.370	125.	89.	87.	WA304
147	COLBY	.160	.430	193.	78.	75.	KS 24
148	COLLAMER	.130	.490	193.	85.	83.	NY157
149	COLLINS	.170	.430	193.	85.	83.	MS 30
150	COLMOR	.120	.370	193.	78.	75.	NM129
151	COLO	.130	.280	108.	78.	75.	IA 71
152	COLOMA	.160	.150	695.	67.	63.	WI181
153	COLONIE	.170	.240	193.	67.	63.	NY 86
154	COLVARD	.150	.150	125.	78.	75.	NC105
155	COLY	.140	.430	108.	78.	75.	NE 23
156	COMORO	.130	.320	193.	78.	75.	AZ 66
157	CONDON	.130	.320	125.	85.	83.	OR 21
158	CONTINE	.130	.280	193.	85.	83.	AZ147
159	COPEMAN	.160	.370	193.	78.	75.	WY404
160	CORNING	.150	.200	193.	89.	87.	CA254
161	COSTILLA	.160	.100	695.	67.	63.	CO 13
162	COWETA	.130	.370	193.	85.	83.	OK108
163	CREIGHTON	.130	.430	193.	78.	75.	WY174
164	CRESBARD	.130	.320	108.	85.	83.	SD 1
165	CRETE	.110	.320	193.	85.	83.	NE 25
166	CRIDER-A	.140	.320	125.	78.	75.	KY 30
167	CRIDER-B	.140	.320	125.	78.	75.	KY 30
168	CROCKETT	.150	.430	193.	89.	87.	TX318
169	CROFTON	.140	.430	193.	78.	75.	NE 26
170	CROSBY	.140	.430	125.	85.	83.	IN 23
171	CROTON	.150	.320	125.	89.	87.	NJ 1
172	CUTHBERT	.180	.370	300.	85.	83.	TX329
173	DARCO	.180	.170	300.	67.	63.	TX637
174	DARNELL	.150	.200	193.	85.	83.	OK 80
175	DARWIN-A	.130	.280	193.	89.	87.	IL 51
176	DARWIN-B	.150	.280	193.	78.	75.	IL 51
177	DAYTON	.140	.430	125.	89.	87.	OR126
178	DELFINA	.150	.240	193.	78.	75.	TX191
179	DELLROSE	.140	.240	125.	78.	75.	TN 74
180	DENNIS	.140	.430	193.	85.	83.	OK 4

Table IV.2.--Continued.
Soils with table IV.1 data available

NUMBER	SERIES NAME	ALBEDO	ERODIBILITY FACTORS		RUNOFF CURVE NUMBER		SOILS CODE
			---WATER---	---WIND---	-ROW CROP-	-SMALL GRAIN-	
181	DENTON	.130	.320	193.	89.	87.	TX142
182	DESCHUTES	.140	.170	193.	85.	83.	OR 30
183	DETROIT	.130	.370	108.	85.	83.	KS 29
184	DEUNAH	.140	.430	125.	89.	87.	ID858
185	DEVEN	.160	.320	108.	89.	87.	CA302
186	DEWEY	.140	.320	193.	78.	75.	TN 20
187	DIMMICK	.110	.280	193.	89.	87.	ND 60
188	DOAK	.160	.370	193.	78.	75.	NM 76
189	DONIPHAN	.140	.280	125.	78.	75.	MO 77
190	DOTHAN	.180	.150	300.	78.	75.	AL 10
191	DOWNER-A	.160	.200	300.	78.	75.	NJ 20
192	DOWNER-B	.160	.240	193.	78.	75.	NJ 85
193	DREWS	.130	.280	193.	78.	75.	OR130
194	DRIGGS	.130	.370	125.	78.	75.	ID 32
195	DRUMMER	.110	.280	85.	78.	75.	IL108
196	DRUMMOND	.130	.490	125.	89.	87.	OK118
197	DUBBS	.140	.370	193.	78.	75.	MS 58
198	DUDLEY	.130	.430	108.	89.	87.	SD 34
199	DUNCANNON	.130	.370	125.	78.	75.	PA 10
200	DUNDAY	.180	.170	300.	67.	63.	NE 30
201	DUNMORE	.180	.320	193.	78.	75.	TN 21
202	DUVAL	.150	.240	193.	78.	75.	TX208
203	DWIGHT	.130	.430	108.	89.	87.	KS 31
204	EAST FORK	.130	.370	193.	85.	83.	NV452
205	EDALGO	.130	.370	108.	85.	83.	KS 32
206	EDEN	.120	.430	193.	85.	83.	KY130
207	EDGEMONT	.130	.150	193.	78.	75.	PA 60
208	EDNA	.130	.370	125.	89.	87.	TX 35
209	EDNEYVILLE	.150	.240	125.	78.	75.	NC 23
210	ELDEAN	.150	.370	125.	78.	75.	OH 3
211	ELLIBER	.150	.240	125.	67.	63.	PA105
212	ELLSWORTH	.150	.430	125.	85.	83.	OH105
213	ELMDALE	.130	.240	193.	78.	75.	MI 19
214	ELSMERE	.180	.170	300.	67.	63.	NE 32
215	EMBDEN	.110	.200	193.	78.	75.	ND 9
216	EMMET -A	.130	.200	193.	78.	75.	MI190
217	EMMET -B	.130	.200	193.	78.	75.	MI190
218	EMMET -C	.130	.200	193.	78.	75.	MI190
219	EMMET -D	.130	.200	193.	78.	75.	MI190
220	EMRICK	.110	.280	125.	78.	75.	ND 30
221	ENDERS-A	.130	.320	193.	85.	83.	AR 2
222	ENDERS-B	.130	.320	193.	85.	83.	AR 2
223	EPHRATA	.150	.320	193.	78.	75.	WA412
224	ERNEST	.180	.280	193.	85.	83.	WV 11
225	ESTHERVILLE	.130	.200	193.	78.	75.	MN 25
226	ETOWAH	.150	.370	193.	78.	75.	TN 34
227	EVESBORO	.150	.170	300.	67.	63.	NJ 16
228	FALFURRIAS	.190	.150	695.	67.	63.	TX229
229	FALLBROOK	.160	.280	193.	78.	75.	CA546
230	FANG-A	.160	.320	193.	78.	75.	NV479
231	FANG-B	.160	.320	193.	78.	75.	NV479
232	FARGO	.110	.320	193.	89.	87.	ND 20
233	FARNUM	.160	.280	108.	78.	75.	KS 38
234	FAYETTE-A	.140	.370	108.	78.	75.	IA 82
235	FAYETTE-B	.140	.370	108.	78.	75.	IA 82
236	FAYETTE-C	.160	.370	108.	78.	75.	IA 82
237	FAYWOOD	.110	.370	108.	89.	87.	KY 14
238	FELTHAM	.180	.200	300.	78.	75.	ID147
239	FILLMORE	.130	.370	108.	89.	87.	NE 34
240	FITCHVILLE	.130	.370	125.	85.	83.	OH 41
241	FLANAGAN	.130	.280	108.	78.	75.	IL137
242	FLAXTON	.130	.200	193.	78.	75.	ND 61
243	FOARD	.150	.490	193.	89.	87.	OK137
244	FORDVILLE-A	.130	.240	108.	78.	75.	SD178
245	FORDVILLE-B	.130	.240	108.	78.	75.	SD178
246	FORESTDALE	.150	.370	193.	89.	87.	MS 2
247	FORT ROCK	.130	.370	193.	85.	83.	OR385
248	FOX	.140	.320	125.	78.	75.	WI 26
249	FRANCITAS	.150	.320	193.	89.	87.	TX633
250	FREEHOLD	.150	.280	193.	78.	75.	NJ 25
251	FREESTONE	.150	.240	193.	85.	83.	TX103
252	FRIO	.130	.320	193.	78.	75.	TX113
253	FRONDORF	.140	.370	125.	78.	75.	KY 47
254	FRUITLAND	.150	.280	193.	78.	75.	NM 80
255	FUGHES	.130	.240	108.	85.	83.	CO506
256	FULLERTON	.150	.280	193.	78.	75.	TN 33
257	FUQUAY	.160	.150	300.	78.	75.	NC 53
258	GABALDON	.140	.430	193.	78.	75.	NM 81
259	GALWAY	.130	.320	108.	78.	75.	NY217
260	GARBUTT	.160	.490	193.	78.	75.	ID148
261	GARVIN	.140	.370	85.	85.	83.	OK258
262	GEARY	.130	.320	108.	78.	75.	KS 40
263	GEFO	.130	.150	695.	67.	63.	CA946
264	GEM	.130	.370	193.	85.	83.	ID391
265	GENOLA	.140	.430	193.	78.	75.	UT744
266	GERMANY	.110	.280	108.	78.	75.	WA194
267	GERRARD	.130	.240	193.	85.	83.	CO243
268	GILFORD	.130	.200	193.	78.	75.	IN 3
269	GILMAN	.130	.550	193.	78.	75.	AZ 2
270	GILPIN-A	.130	.320	125.	85.	83.	PA 7

Table IV.2.--Continued.
Soils with table IV.1 data available

NUMBER	SERIES NAME	ALBEDO	ERODIBILITY FACTORS		RUNOFF CURVE NUMBER		SOILS CODE
			---WATER---	---WIND---	-ROW CROP-	-SMALL GRAIN-	
271	GILPIN-B	.150	.320	193.	85.	83.	PA 7
272	GILPIN-C	.130	.320	108.	85.	83.	PA 7
273	GLEN	.130	.200	193.	78.	75.	WA464
274	GLENBAR	.130	.430	193.	78.	75.	AZ 23
275	GLENBERG	.130	.150	193.	78.	75.	CO 58
276	GLENDALE	.130	.320	193.	78.	75.	AZ130
277	GLENDIVE	.150	.320	125.	78.	75.	MT 66
278	GLENHAM-A	.130	.280	108.	78.	75.	SD172
279	GLENHAM-B	.130	.280	108.	78.	75.	SD172
280	GLENTON	.130	.240	193.	85.	83.	WY 19
281	GOLDSTON	.140	.240	193.	85.	83.	NC 33
282	GORGAS	.130	.200	300.	89.	87.	AL109
283	GRACEMONT	.130	.320	125.	85.	83.	OK 73
284	GRANBY	.130	.240	193.	67.	63.	MI 29
285	GRANT	.140	.370	125.	78.	75.	OK 47
286	GRAYPOINT	.130	.150	108.	78.	75.	CO212
287	GREENBRAE	.140	.150	193.	85.	83.	NV 59
288	GREENWOOD	.080	.000	300.	67.	63.	MI1143
289	GRENADA	.140	.430	193.	85.	83.	MS 1
290	GRENVILLE	.130	.320	193.	78.	75.	NY209
291	GRIFFY	.140	.320	193.	78.	75.	WY 22
292	GRIGSBY	.130	.320	108.	78.	75.	KY 95
293	GROSECLOSE	.130	.430	125.	85.	83.	VA 84
294	GRUNDY	.130	.370	108.	85.	83.	MO 1
295	GUERNSEY	.140	.430	108.	85.	83.	OH 59
296	GUTHRIE-A	.130	.430	193.	89.	87.	TN 45
297	GUTHRIE-B	.130	.430	193.	89.	87.	TN 45
298	HADLEY	.130	.490	193.	78.	75.	MA 22
299	HAGERSTOWN-A	.130	.320	108.	85.	83.	MD 4
300	HAGERSTOWN-B	.130	.320	193.	85.	83.	MD 4
301	HAMMONTON	.160	.200	300.	78.	75.	NJ 19
302	HANFORD	.150	.320	193.	78.	75.	CA 32
303	HAPGOOD	.130	.170	108.	78.	75.	NV253
304	HARKEY	.170	.550	193.	78.	75.	NM186
305	HARLAN	.140	.430	125.	78.	75.	WY 6
306	HARLEM	.150	.370	85.	85.	83.	MT101
307	HARLINGEN	.160	.320	193.	89.	87.	TX412
308	HARNEY	.130	.320	108.	78.	75.	KS 47
309	HARTSELLS	.170	.280	193.	78.	75.	AL 39
310	HASSEE	.130	.430	125.	89.	87.	TX203
311	HASTINGS	.130	.320	108.	78.	75.	NE 41
312	HAVEN	.130	.320	193.	78.	75.	NY 2
313	HAVERSON	.160	.240	193.	78.	75.	CO 23
314	HAVRE	.140	.370	193.	78.	75.	MT 72
315	HAWICK	.140	.170	300.	67.	63.	MN354
316	HAXTUN	.160	.150	300.	78.	75.	CO 24
317	HAYESVILLE-A	.130	.200	193.	78.	75.	NC 13
318	HAYESVILLE-B	.130	.200	193.	78.	75.	NC 13
319	HAYESVILLE-C	.160	.200	108.	78.	75.	NC 13
320	HAZLETON	.130	.170	125.	78.	75.	PA 80
321	HEALING	.130	.370	125.	78.	75.	AR 33
322	HECLA	.160	.170	300.	67.	63.	SD134
323	HEIDEN	.130	.320	193.	89.	87.	TX151
324	HELDT-A	.130	.280	193.	85.	83.	WY 2
325	HELDT-B	.130	.280	193.	85.	83.	WY 2
326	HELMER	.130	.430	125.	85.	83.	ID112
327	HERMON-A	.130	.170	193.	67.	63.	ME 1
328	HERMON-B	.130	.170	193.	67.	63.	ME 1
329	HESPERUS	.130	.280	108.	78.	75.	CO183
330	HEUVELTON	.130	.370	193.	85.	83.	NY318
331	HICKORY	.130	.370	125.	85.	83.	IL 19
332	HIDALGO	.150	.240	193.	78.	75.	TX226
333	HIKO SPRINGS	.130	.240	193.	78.	75.	UT147
334	HILTON	.130	.320	125.	78.	75.	NY129
335	HINCKLEY	.130	.200	300.	67.	63.	MA 24
336	HITILLO	.190	.170	695.	67.	63.	TX739
337	HOBBS	.130	.320	108.	78.	75.	NE104
338	HOBSON	.140	.370	125.	85.	83.	MO109
339	HOGANSBURG	.130	.320	193.	78.	75.	NY215
340	HOLDREGE-A	.140	.320	108.	78.	75.	NE 44
341	HOLDREGE-B	.140	.320	108.	78.	75.	NE 44
342	HOLLAND	.130	.320	193.	78.	75.	CA392
343	HONDALE	.130	.430	300.	89.	87.	NM193
344	HOOD	.140	.430	125.	78.	75.	OR 46
345	HOPESTON	.130	.200	193.	78.	75.	IL 80
346	HORD	.130	.320	193.	78.	75.	NE 45
347	HORTONVILLE	.150	.240	193.	78.	75.	WI130
348	HOSMER-A	.140	.430	125.	85.	83.	IN 54
349	HOSMER-B	.140	.430	125.	85.	83.	IN 54
350	HOT LAKE	.140	.320	108.	85.	83.	OR631
351	HOUGHTON	.080	.000	300.	67.	63.	MI 24
352	HOUSTON	.130	.370	193.	89.	87.	AL 64
353	HOUSTON BLACK	.130	.320	193.	89.	87.	TX 93
354	HUENEME	.130	.280	193.	85.	83.	CA104
355	HUMBOLDT	.130	.280	193.	89.	87.	NV 15
356	HUNTINGTON-A	.130	.280	108.	78.	75.	WV 5
357	HUNTINGTON-B	.130	.280	108.	78.	75.	WV 5
358	HUNTINGTON-C	.130	.280	85.	78.	75.	WV 5
359	HUNTINGTON-D	.130	.280	108.	78.	75.	WV 5
360	HURRICANE	.130	.100	695.	85.	83.	FL379

Table IV.2.--Continued.
Soils with table IV.1 data available

NUMBER	SERIES NAME	ALBEDO	ERODIBILITY FACTORS		RUNOFF CURVE NUMBER		SOILS CODE
			---WATER---	---WIND---	ROW CROP	SMALL GRAIN	
361	IDA-A	.140	.430	193.	78.	75.	IA166
362	IDA-B	.140	.430	193.	78.	75.	IA166
363	IMMOKALEE	.190	.100	695.	78.	75.	FL 58
364	INDIANOLA	.130	.240	300.	67.	63.	WA 17
365	IRON RIVER	.130	.280	125.	78.	75.	MI 76
366	IRWIN	.130	.370	85.	89.	87.	KS 53
367	JACKKNIFE	.130	.320	108.	85.	83.	ID273
368	JORY	.130	.170	85.	78.	75.	OR314
369	JOSEPHINE-A	.130	.200	125.	78.	75.	OR317
370	JOSEPHINE-B	.130	.200	193.	78.	75.	OR317
371	JUDITH	.130	.320	193.	78.	75.	MT104
372	KALKASKA	.130	.150	695.	67.	63.	MI 98
373	KATEMICY	.130	.320	193.	85.	83.	TX437
374	KAWKAWLIN	.130	.320	108.	85.	83.	MI147
375	KEENO	.140	.240	108.	85.	83.	MO 88
376	KEITH-A	.140	.320	108.	78.	75.	NE 49
377	KEITH-B	.140	.320	108.	78.	75.	NE 49
378	KEITH-C	.140	.320	125.	78.	75.	NE 49
379	KENANSVILLE	.160	.150	695.	67.	63.	NC132
380	KENDRICK	.160	.150	695.	67.	63.	FL 5
381	KENNEBEC	.110	.320	108.	78.	75.	IA 70
382	KENNER-A	.080	.000	300.	89.	87.	LA 13
383	KENNER-B	.080	.000	0.	89.	87.	LA 13
384	KENOMA	.130	.430	108.	89.	87.	KS 58
385	KENYON-A	.130	.280	108.	78.	75.	IA 48
386	KENYON-B	.130	.280	108.	78.	75.	IA 48
387	KEWAUNEE	.130	.370	125.	85.	83.	WI 75
388	KEYPORT	.130	.430	125.	85.	83.	NJ 52
389	KIPLING	.140	.320	193.	89.	87.	MS 39
390	KIRVIN	.150	.370	193.	85.	83.	TX331
391	KNIPPA	.130	.320	193.	85.	83.	TX435
392	KONAWA	.150	.240	193.	78.	75.	OK 32
393	KRANZBURG	.110	.320	108.	78.	75.	SD161
394	KRUM	.120	.320	193.	89.	87.	TX 29
395	KYLE	.160	.370	193.	89.	87.	SD 78
396	LACKAWANNA	.130	.320	193.	85.	83.	PA 20
397	LAKE CHARLES	.130	.320	193.	89.	87.	TX 20
398	LAKEVIEW	.160	.280	108.	85.	83.	OR139
399	LANCASTER	.130	.280	108.	78.	75.	KS 64
400	LAPEER	.130	.240	193.	78.	75.	MI 17
401	LAPINE	.130	.100	193.	67.	63.	OR175
402	LATHAM	.140	.430	85.	89.	87.	OH 29
403	LAWRENCE	.130	.430	125.	85.	83.	KY 56
404	LEADVALE	.130	.430	125.	85.	83.	TN 55
405	LEAL	.130	.240	125.	78.	75.	CO184
406	LEEPER	.130	.320	193.	89.	87.	MS 9
407	LEON	.130	.100	695.	78.	75.	FL 51
408	LESWILL	.140	.370	193.	78.	75.	CO400
409	LICKSKILLET	.130	.170	193.	89.	87.	OR 55
410	LIHEN	.150	.200	300.	67.	63.	MT 12
411	LIMA	.110	.320	193.	85.	83.	NY120
412	LINKER-A	.150	.280	193.	78.	75.	AR 49
413	LINKER-B	.150	.280	193.	78.	75.	AR 49
414	LINKER-C	.150	.280	193.	78.	75.	AR 49
415	LINKER-D	.150	.280	193.	78.	75.	AR 49
416	LINNE	.130	.280	193.	85.	83.	CA 35
417	LITTLE	.130	.370	193.	89.	87.	NM123
418	LIVIA	.140	.490	125.	89.	87.	TX635
419	LOCHLOOSA	.130	.100	695.	85.	83.	FL 15
420	LONNA	.140	.370	193.	78.	75.	MT156
421	LORING	.140	.490	193.	85.	83.	TN 11
422	LOWELL	.130	.370	85.	85.	83.	KY 32
423	LUCY	.160	.150	300.	67.	63.	AL 1
424	LUFKIN	.150	.430	193.	89.	87.	TX302
425	LUHON	.140	.280	193.	78.	75.	CO429
426	LUTE	.180	.240	193.	89.	87.	SD131
427	LYMAN	.130	.280	193.	85.	83.	MA 28
428	LYNCHBURG	.130	.150	300.	85.	83.	SC 37
429	LYNX	.130	.240	125.	78.	75.	AZ116
430	MADISON	.150	.240	193.	78.	75.	NC 71
431	MADRID	.130	.320	193.	78.	75.	NY114
432	MAHONING	.130	.430	108.	89.	87.	OH120
433	MALBIS	.150	.240	193.	78.	75.	AL 59
434	MARDIN-A	.130	.320	193.	85.	83.	NY 60
435	MARDIN-B	.130	.320	193.	85.	83.	NY 60
436	MARLETTE-A	.130	.320	125.	78.	75.	MI 83
437	MARLETTE-B	.130	.320	193.	78.	75.	MI 83
438	MARLOW	.130	.240	193.	85.	83.	NH 9
439	MARSHALL	.130	.320	85.	78.	75.	IA 23
440	MARTINSDALE	.130	.370	193.	78.	75.	MT234
441	MARVAN	.150	.370	193.	89.	87.	MT114
442	MATAPEAKE	.140	.370	125.	78.	75.	MD 37
443	MAURY	.130	.320	108.	78.	75.	KY 45
444	MECKESVILLE	.130	.320	125.	85.	83.	PA 31
445	MEDFORD	.140	.370	193.	85.	83.	OR442
446	MELBOURNE	.110	.320	193.	78.	75.	WA180
447	MEMPHIS	.140	.490	193.	78.	75.	MS 66
448	MENAHGA-A	.140	.150	695.	67.	63.	MN 57
449	MENAHGA-B	.140	.150	695.	67.	63.	MN 57
450	MERRIMAC	.130	.240	193.	67.	63.	MA 26

Table IV.2.--Continued.
Soils with table IV.1 data available

NUMBER	SERIES NAME	ALBEDO	EROIDABILITY FACTORS		RUNOFF CURVE NUMBER		SOILS CODE
			---WATER---	---WIND---	-ROW CROP-	-SMALL GRAIN-	
451	METZ	.150	.320	300.	67.	63.	CA 41
452	MEXICO	.130	.430	108.	89.	87.	MO 56
453	MIAMI	.130	.370	125.	78.	75.	IN 13
454	MILES	.150	.240	193.	78.	75.	TX245
455	MILLBORO	.130	.370	193.	89.	87.	SD116
456	MILLSHOLM	.130	.370	108.	89.	87.	CA 42
457	MIMOSA	.140	.370	193.	85.	83.	TN 98
458	MINNEQUA	.140	.320	193.	85.	83.	CO 34
459	MOHALL	.130	.200	193.	78.	75.	AZ 33
460	MONADNOCK	.110	.280	193.	78.	75.	NH 34
461	MONASTERIO	.130	.150	193.	78.	75.	ID357
462	MONICO	.130	.320	193.	85.	83.	WI344
463	MONONA	.130	.320	108.	78.	75.	IA160
464	MONSERATE	.130	.430	193.	85.	83.	CA122
465	MONTELL	.120	.320	193.	89.	87.	TX213
466	MOODY	.130	.320	85.	78.	75.	SD 61
467	MORA	.150	.280	125.	85.	83.	MN249
468	MORLEY-A	.130	.430	125.	85.	83.	IL 17
469	MORLEY-B	.130	.430	108.	85.	83.	IL 17
470	MOUNTAINVIEW	.080	.000	300.	85.	83.	ID665
471	MULTNOMAH	.130	.280	85.	78.	75.	OR556
472	MUNISING	.130	.240	193.	78.	75.	MI151
473	MYAKKA	.130	.100	695.	78.	75.	FL 59
474	NAVAJO	.130	.280	193.	89.	87.	AZ117
475	NEBISH	.130	.320	193.	78.	75.	MN138
476	NELLIS	.130	.320	125.	78.	75.	NY211
477	NEUNS	.130	.150	125.	85.	83.	CA743
478	NEWARK	.130	.430	193.	85.	83.	KY 3
479	NEWDALE	.140	.430	125.	78.	75.	ID 34
480	NIBSON	.140	.320	193.	89.	87.	KS 85
481	NICOLLET	.110	.240	108.	78.	75.	MN 34
482	NIOBELL	.130	.320	108.	85.	83.	ND 41
483	NIXA	.140	.320	125.	85.	83.	AR 5
484	NOARK	.140	.280	125.	78.	75.	AR 34
485	NOLIN	.130	.430	125.	78.	75.	KY 17
486	NORA	.130	.320	108.	78.	75.	SD 60
487	NORFOLK-A	.140	.170	300.	78.	75.	NC 37
488	NORFOLK-B	.130	.170	300.	78.	75.	NC 37
489	NORKA	.130	.320	125.	78.	75.	CO 71
490	NORREST	.130	.370	193.	85.	83.	SD203
491	NORWOOD	.140	.430	85.	78.	75.	TX305
492	NUNN	.130	.240	108.	85.	83.	CO 38
493	NUTLEY	.110	.280	193.	85.	83.	SD 53
494	NUVALDE	.130	.280	193.	78.	75.	TX502
495	OAKVILLE	.160	.150	300.	67.	63.	MI 38
496	OBRAV	.130	.240	193.	89.	87.	UT559
497	OLTON	.150	.320	108.	85.	83.	TX129
498	ONAWAY	.160	.240	193.	78.	75.	MI195
499	ONDAWA	.130	.240	193.	78.	75.	ME 10
500	ONTONAGON-A	.160	.280	193.	89.	87.	MI 75
501	ONTONAGON-B	.160	.280	193.	89.	87.	MI 75
502	ORANGEBURG	.140	.170	193.	78.	75.	GA 29
503	ORNBAUN	.130	.320	125.	78.	75.	CA314
504	OROVADA	.130	.490	125.	78.	75.	NV 96
505	ORTEGA	.190	.100	695.	67.	63.	FL187
506	OSHEMO	.190	.240	193.	78.	75.	MI 13
507	OTERO	.130	.200	193.	78.	75.	CO 40
508	OVERLY	.110	.320	125.	85.	83.	ND 69
509	OVERTON	.160	.280	193.	89.	87.	NV154
510	OWYHEE	.160	.490	125.	78.	75.	ID151
511	PACTOLA	.130	.280	108.	78.	75.	SD244
512	PANCHERI	.140	.490	193.	78.	75.	ID 37
513	PAOLA	.140	.100	395.	89.	87.	FL 56
514	PARKDALE	.130	.430	125.	78.	75.	OR 73
515	PARLEYS	.140	.320	193.	78.	75.	UT 62
516	PARNELL	.110	.280	85.	85.	83.	MN 35
517	PARR	.130	.320	125.	78.	75.	IN 35
518	PARSONS	.130	.490	108.	89.	87.	OK 11
519	PATNA	.130	.150	695.	78.	75.	NV283
520	PAWNEE	.130	.370	108.	89.	87.	NE 76
521	PAXTON	.130	.240	193.	85.	83.	CT 60
522	PEDERNALES	.150	.320	193.	85.	83.	TX139
523	PENN-A	.150	.320	125.	85.	83.	PA 75
524	PENN-B	.150	.320	193.	85.	83.	PA 75
525	PERIDGE	.150	.370	125.	78.	75.	AR 19
526	PERU	.130	.240	125.	85.	83.	NH 13
527	PESCADERO	.130	.370	0.	89.	87.	CA274
528	PICKFORD	.130	.370	193.	89.	87.	MI157
529	PIERRE-A	.130	.370	193.	89.	87.	SD 77
530	PIERRE-B	.130	.370	193.	89.	87.	SD 77
531	PIERRE-C	.150	.370	193.	89.	87.	SD 77
532	PIMA	.130	.490	193.	78.	75.	AZ 89
533	PINEDA	.130	.100	695.	78.	75.	FL 80
534	PITTSFIELD	.130	.240	125.	78.	75.	MA 14
535	PIZENE	.130	.280	695.	78.	75.	NV203
536	PLAINFIELD-A	.180	.170	300.	67.	63.	WI168
537	PLAINFIELD-B	.160	.170	300.	67.	63.	WI168
538	PLANKINTON	.130	.240	125.	89.	87.	SD302
539	PLANO-A	.130	.320	108.	78.	75.	IL260
540	PLANO-B	.130	.320	108.	78.	75.	IL260

Table IV.2.--Continued.
Soils with table IV.1 data available

NUMBER	SERIES NAME	ALBEDO	ERODIBILITY FACTORS		RUNOFF CURVE NUMBER		SOILS CODE
			---WATER---	---WIND---	-ROW CROP-	-SMALL GRAIN-	
541	POARCH	.150	.200	193.	78.	75.	AL 35
542	POCOMOKE	.110	.280	193.	78.	75.	MD 2
543	POINSETT	.130	.320	108.	78.	75.	SD180
544	POLEY	.150	.170	193.	85.	83.	AZ160
545	POLLARD	.130	.240	108.	85.	83.	OR649
546	POMELLO	.130	.100	695.	85.	83.	FL 78
547	POPE	.130	.280	125.	78.	75.	KY 18
548	PORT BYRON	.130	.320	108.	78.	75.	IL 63
549	PORTNEUF	.150	.200	193.	78.	75.	ID 1
550	POSITAS	.150	.370	193.	89.	87.	CA278
551	PRATT	.180	.170	300.	67.	63.	KS 93
552	PROMISE-A	.130	.370	193.	89.	87.	SD 71
553	PROMISE-B	.180	.170	300.	67.	63.	SD 71
554	PUGET	.110	.280	125.	89.	87.	WA 13
555	PULASKI	.180	.320	193.	78.	75.	OK 35
556	PULLMAN	.150	.370	108.	89.	87.	TX247
557	PYWELL	.080	.000	300.	89.	87.	ID 14
558	QUINCY	.190	.170	695.	67.	63.	WA 64
559	RAMADERO	.130	.280	125.	78.	75.	TX 82
560	RAMELLI	.110	.200	193.	89.	87.	CA432
561	RAMONA	.130	.370	193.	78.	75.	CA120
562	RANDALL	.130	.320	193.	89.	87.	TX248
563	RAWSON	.130	.320	125.	78.	75.	OH 95
564	RAYNE	.140	.280	125.	78.	75.	PA 68
565	READING	.130	.320	108.	78.	75.	KS 95
566	READLYN	.130	.240	108.	78.	75.	IA 61
567	RED BLUFF	.130	.200	108.	78.	75.	CA972
568	RED HOOK	.110	.320	193.	85.	83.	NY205
569	REDDICK-A	.110	.280	85.	78.	75.	IL 7
570	REDDICK-B	.110	.280	85.	78.	75.	IL 7
571	RENFROW	.140	.490	108.	89.	87.	OK 90
572	RENOHILL	.140	.370	193.	85.	83.	WY106
573	RENSLOW	.140	.490	125.	78.	75.	WA419
574	RENTSAC	.140	.200	193.	89.	87.	MT120
575	RESOTA	.130	.100	695.	67.	63.	FL327
576	RHINEBECK-A	.130	.490	193.	89.	87.	NY 48
577	RHINEBECK-B	.130	.490	108.	89.	87.	NY 48
578	RICHFIELD	.140	.320	108.	78.	75.	KS 96
579	RIDDLES	.140	.320	193.	78.	75.	IN 15
580	RIDGEVILLE	.130	.200	193.	78.	75.	IL120
581	RILLITO	.130	.150	0.	78.	75.	AZ 39
582	RINCON	.140	.370	0.	85.	83.	CA 56
583	RINKER	.130	.100	193.	85.	83.	WA513
584	RIRIE	.130	.430	193.	78.	75.	ID355
585	RITZVILLE	.140	.430	125.	78.	75.	WA 31
586	ROCKY FORD	.140	.320	193.	78.	75.	CO 46
587	ROSEBUD	.130	.280	108.	78.	75.	NE 79
588	ROUSSEAU	.190	.150	695.	67.	63.	MI 99
589	ROXBURY	.130	.320	193.	78.	75.	KS 99
590	RUSTON	.150	.150	193.	78.	75.	LA 57
591	SALISBURY	.130	.370	193.	89.	87.	OR136
592	SALTAIR	.150	.490	193.	89.	87.	UT161
593	SAN ARCACIO	.150	.240	193.	85.	83.	CO419
594	SAN EMIGDIO-A	.130	.320	125.	78.	75.	CA138
595	SAN EMIGDIO-B	.130	.320	193.	78.	75.	CA138
596	SANSARC-A	.130	.370	193.	89.	87.	SD 67
597	SANSARC-B	.130	.370	193.	89.	87.	SD 67
598	SANTIAGO-A	.130	.370	125.	78.	75.	WI137
599	SANTIAGO-B	.130	.370	125.	78.	75.	WI137
600	SARITA	.190	.170	300.	67.	63.	TX 39
601	SARPY	.130	.150	695.	67.	63.	MO 16
602	SASSAFRAS	.130	.280	193.	78.	75.	MD 39
603	SATANTA	.130	.200	0.	89.	87.	KS102
604	SCOBAY	.150	.200	108.	85.	83.	MT124
605	SEATON	.140	.370	108.	78.	75.	IL 67
606	SEBRING	.130	.370	193.	78.	75.	OH 43
607	SEGNO-A	.150	.320	193.	85.	83.	TX 2
608	SEGNO-B	.150	.320	193.	85.	83.	TX 2
609	SEQUATCHIE	.150	.320	193.	78.	75.	TN 35
610	SHANO	.150	.430	125.	78.	75.	WA315
611	SHARKEY-A	.150	.430	193.	89.	87.	LA 50
612	SHARKEY-B	.150	.430	193.	89.	87.	LA 50
613	SHARPSBURG	.130	.320	85.	78.	75.	IA 33
614	SHELBY	.130	.280	108.	78.	75.	IA142
615	SHELL	.130	.320	108.	78.	75.	NE222
616	SHELLABARGER	.150	.200	193.	78.	75.	KS103
617	SHELOCTA-A	.130	.320	125.	78.	75.	KY 20
618	SHELOCTA-B	.130	.320	193.	78.	75.	KY 20
619	SHINGLE	.130	.320	193.	89.	87.	WY 90
620	SHOOKER	.130	.320	108.	85.	83.	MN139
621	SHOWLOW	.150	.240	125.	85.	83.	AZ121
622	SIERRA	.160	.280	193.	78.	75.	CA297
623	SILAWA	.150	.240	193.	78.	75.	TX346
624	SIMAS	.130	.280	125.	85.	83.	OR249
625	SITES	.110	.100	108.	85.	83.	CA298
626	SKERRY	.130	.240	193.	85.	83.	NH 3
627	SKYKOMISH	.110	.170	193.	67.	63.	WA481
628	SLAW	.140	.550	85.	85.	83.	NV836
629	SMILEY	.130	.240	193.	78.	75.	MN413
630	SOLANO	.130	.370	0.	89.	87.	CA100

Table IV.2.--Continued.
Soils with table IV.1 data available

NUMBER	SERIES NAME	ALBEDO	EROOSIBILITY FACTORS		RUNOFF CURVE NUMBER		SOILS CODE
			---WATER---	---WIND---	-ROW CROP-	SMALL GRAIN-	
631	SOLDUC	.080	.100	193.	78.	75.	WA594
632	SPADRA	.150	.370	125.	78.	75.	AR 36
633	SPEARVILLE	.130	.370	85.	85.	83.	KS108
634	SPINKS-A	.130	.170	300.	67.	63.	MI 5
635	SPINKS-B	.130	.170	300.	67.	63.	MI 5
636	SPLENDORA	.150	.430	193.	85.	83.	TX306
637	SPRINGDALE	.130	.100	193.	67.	63.	WA158
638	ST. PAUL	.140	.370	108.	78.	75.	OK 70
639	STENDAL-A	.150	.370	193.	85.	83.	IN 58
640	STENDAL-B	.150	.370	125.	85.	83.	IN 58
641	STEPHENVILLE	.180	.200	300.	78.	75.	OK 91
642	STIMSON	.110	.370	125.	89.	87.	WA204
643	STIRUM	.110	.240	193.	78.	75.	ND149
644	STIVERSVILLE	.150	.320	125.	78.	75.	TN112
645	STOUGH	.130	.280	193.	85.	83.	MS 46
646	STRATTON	.170	.490	193.	85.	83.	VT 54
647	STRAWN	.140	.370	108.	78.	75.	IL227
648	SUDBURY	.130	.240	193.	78.	75.	MA 27
649	SUFFOLK	.150	.280	300.	78.	75.	VA 58
650	SUMTER	.130	.370	193.	85.	83.	AL 11
651	SUNCOOK	.130	.170	300.	67.	63.	CT 1
652	SUSQUEHANNA	.150	.280	193.	89.	87.	MS 32
653	TABLER	.150	.490	108.	89.	87.	OK163
654	TAMA	.130	.320	85.	78.	75.	IA 49
655	TAMALCO	.130	.430	108.	89.	87.	IL176
656	TAPPAN	.130	.280	125.	78.	75.	MI220
657	TARRANT	.130	.200	0.	89.	87.	TX 91
658	TAVARES	.130	.100	695.	67.	63.	FL 21
659	TAWAS	.080	.000	300.	67.	63.	MI 27
660	TERRA CEIA	.080	.000	300.	89.	87.	FL 31
661	TETONIA	.130	.370	125.	78.	75.	ID217
662	TETONKA	.130	.240	108.	85.	83.	SD 44
663	THROCK	.180	.320	193.	85.	83.	TX524
664	THURBER	.180	.430	193.	89.	87.	TX204
665	TIFTON	.160	.100	300.	78.	75.	GA 1
666	TIVOLI	.180	.170	300.	67.	63.	OK 93
667	TONKA	.110	.320	108.	85.	83.	ND 26
668	TOPSEY	.180	.320	193.	85.	83.	TX942
669	TOURS-A	.130	.370	193.	78.	75.	AZ128
670	TOURS-B	.180	.370	193.	78.	75.	AZ128
671	TUB	.130	.280	108.	85.	83.	OR 98
672	TUBAC	.130	.240	125.	85.	83.	AZ168
673	TULANA	.080	.020	85.	78.	75.	OR287
674	TURNER	.130	.370	108.	78.	75.	MT 22
675	TURRIA	.130	.280	193.	78.	75.	NV476
676	ULY	.140	.370	85.	85.	83.	NE 90
677	ULYSSES	.140	.320	108.	78.	75.	KS113
678	UMAPINE	.180	.240	125.	89.	87.	WA179
679	UNADILLA	.130	.490	193.	78.	75.	NY222
680	UPSHUR	.140	.320	193.	89.	87.	WV 49
681	UVALDE	.140	.280	193.	78.	75.	TX231
682	VAIDEN-A	.140	.320	193.	89.	87.	AL 17
683	VAIDEN-B	.140	.320	193.	89.	87.	AL 17
684	VALE	.130	.320	193.	78.	75.	SD 86
685	VALENTINE	.190	.150	695.	67.	63.	NE 91
686	VASQUEZ	.190	.100	125.	78.	75.	CO 51
687	VAUCLUSE	.160	.150	300.	85.	83.	SC 8
688	VENUS-A	.180	.280	193.	78.	75.	TX146
689	VENUS-B	.130	.280	193.	78.	75.	TX146
690	VERDIGRIS	.130	.320	108.	78.	75.	KS114
691	VERMEJO	.130	.320	193.	78.	75.	NM151
692	VINT	.180	.100	300.	78.	75.	AZ 50
693	VISTA	.160	.320	193.	78.	75.	CA 71
694	WABASSO	.130	.100	695.	78.	75.	FL 75
695	WAINOLA	.130	.150	695.	78.	75.	MI212
696	WALDECK	.150	.200	193.	85.	83.	KS117
697	WALLA WALLA	.130	.430	125.	78.	75.	WA 26
698	WAMIC	.130	.490	125.	78.	75.	OR106
699	WAPSIE	.130	.280	125.	78.	75.	IA 56
700	WARDEN	.130	.430	125.	78.	75.	WA167
701	WASHOE	.130	.100	300.	78.	75.	NV327
702	WATTON	.130	.370	125.	85.	83.	MI 4
703	WEBSTER	.110	.240	108.	78.	75.	IA 72
704	WEIKERT	.130	.280	125.	78.	75.	PA 24
705	WELD	.160	.370	193.	85.	83.	CO 54
706	WELLS	.130	.280	125.	78.	75.	KS129
707	WELLSTON	.130	.370	125.	78.	75.	OH 1
708	WERNOCK	.130	.370	125.	78.	75.	KY 78
709	WESTMORELAND	.130	.370	193.	78.	75.	PA 73
710	WHEELING	.140	.370	193.	78.	75.	WV 12
711	WHITE HOUSE	.140	.200	125.	85.	83.	AZ101
712	WILEY	.130	.370	193.	78.	75.	CO 55
713	WILLAMETTE	.130	.320	108.	78.	75.	OR125
714	WILLIAMS-A	.130	.280	125.	78.	75.	ND 42
715	WILLIAMS-B	.130	.280	108.	78.	75.	ND 42
716	WILLIAMS-C	.130	.280	108.	78.	75.	ND 42
717	WINDSOR	.130	.170	300.	67.	63.	CT 14
718	WINDTHORST	.150	.490	193.	85.	83.	TX265
719	WINONA	.130	.320	193.	89.	87.	AZ169
720	WINOOSKI	.130	.490	193.	78.	75.	MA 23

Table IV.2.--Continued.
Soils with table IV.1 data available

NUMBER	SERIES NAME	ALBEDO	ERODIBILITY FACTORS		RUNOFF CURVE NUMBER		SOILS CODE
			---WATER---	---WIND---	-ROW CROP-	-SMALL GRAIN-	
721	WODEN	.150	.200	193.	78.	75.	TX188
722	WOOD RIVER	.130	.280	193.	89.	87.	NE 94
723	WOODBURN	.130	.320	125.	85.	83.	OR325
724	WOODWARD	.130	.370	193.	78.	75.	OK 71
725	WYEAST	.140	.490	125.	85.	83.	OR118
726	WYMORE	.140	.370	85.	85.	83.	NE 95
727	WYNNVILLE	.130	.240	193.	78.	75.	AL 42
728	WYOCENA	.150	.170	300.	78.	75.	WI251
729	YAUHANNAH	.130	.170	193.	78.	75.	SC 97
730	YELLOWHOUND	.150	.280	125.	78.	75.	CA850
731	YOLO	.150	.370	193.	78.	75.	CA167
732	ZAHL	.130	.280	193.	78.	75.	ND 48
733	ZANESVILLE	.150	.430	193.	85.	83.	KY 1
734	ZOHNER	.130	.320	193.	89.	87.	ID667
735	ZOOK	.110	.280	85.	85.	83.	IA 73
736	ZUBER	.130	.150	300.	78.	75.	FL 38
737	ZUNDELL	.130	.240	108.	85.	83.	ID666

APPENDIX V: FARM MACHINERY

Table V.1.
EPIC tillage parameters

Number	Name (1)	COTL (\$) (2)	EMX	RR (mm)	TLD (mm)	RMT (mm)	RIN (m)	DKH (mm)	DKI (m)	IHC	HE	ORHI
1	LISTRPLT	19.77	.15	10.00	40.00	75.00	1.00	.00	.00	5.00	.00	.00
2	ROW PLT	20.00	.05	5.00	60.00	10.00	.86	.00	.00	5.00	.00	.00
3	PLANT DR	17.54	.25	10.00	40.00	25.00	.17	.00	.00	6.00	.00	.00
4	TRSPLANT	19.77	.15	10.00	500.00	75.00	1.00	.00	.00	5.00	.00	.00
10	SPREADER	7.66	.00	.00	.00	.00	.00	.00	.00	.00	.00	.00
11	SPRAYER	6.80	.00	.00	.00	.00	.00	.00	.00	.00	.00	.00
12	ANHYD AP	4.94	.15	13.00	75.00	25.00	.30	.00	.00	.00	.00	.00
15	LISTER	9.14	.80	25.00	100.00	150.00	1.00	.00	.00	.00	.00	.00
16	DISK BED	9.74	.70	.00	100.00	75.00	1.00	.00	.00	.00	.00	.00
17	ROWBUILD	.00	.50	15.00	350.00	300.00	1.78	.00	.00	.00	.00	.00
18	CULTPACK	.00	.10	5.00	40.00	25.00	1.78	.00	.00	.00	.00	.00
19	ROW CULT	13.52	.30	15.00	25.00	100.00	1.00	.00	.00	.00	.00	.00
20	FLD CULT	12.36	.30	6.00	50.00	25.00	.25	.00	.00	.00	.00	.00
21	ROT HOE	13.20	.10	13.00	5.00	.00	.00	.00	.00	.00	.00	.00
22	ROD WEED	8.90	.05	10.00	25.00	.00	.00	.00	.00	.00	.00	.00
23	SWEEP	9.18	.30	15.00	75.00	.00	.00	.00	.00	.00	.00	.00
24	NOBLE PL	9.18	.10	15.00	100.00	.00	.00	.00	.00	.00	.00	.00
25	SPIK HAR	13.20	.20	13.00	25.00	.00	.00	.00	.00	.00	.00	.00
26	SAND F	13.20	.10	20.00	15.00	.00	.00	.00	.00	.00	.00	.00
28	MB PLOW	27.18	.90	30.00	150.00	.00	.00	.00	.00	.00	.00	.00
29	TAN DISK	13.44	.50	18.00	75.00	.00	.00	.00	.00	.00	.00	.00
30	PT-CHS	8.95	.37	20.00	150.00	50.00	.30	.00	.00	.00	.00	.00
31	TWPT-CHS	8.95	.42	25.00	150.00	75.00	.30	.00	.00	.00	.00	.00
32	SWP-CHS	8.95	.33	20.00	100.00	25.00	.30	.00	.00	.00	.00	.00
33	OFFSET-D	19.87	.75	50.00	100.00	.00	.00	.00	.00	.00	.00	.00
34	SUBSOIL	.00	.20	15.00	350.00	.00	.00	.00	.00	.00	.00	.00
41	KILL	.00	.00	.00	.00	.00	.00	.00	.00	1.00	.00	.00
42	CHISEL K	8.95	.33	20.00	200.00	50.00	300.00	.00	.00	1.00	.00	.00
43	MB PLW K	27.18	.90	30.00	150.00	.00	.00	.00	.00	1.00	.00	.00
44	OFFSET K	19.87	.75	50.00	100.00	.00	.00	.00	.00	1.00	.00	.00
50	HARV1.95	25.00	.00	.00	.00	.00	.00	.00	.00	1.00	.95	.00
51	HARV2.95	25.00	.00	.00	-100.00	.00	.00	.00	.00	2.00	.95	.00
52	HARVOR75	25.00	.00	.00	-150.00	.00	.00	.00	.00	2.00	.95	.75
53	HARVOR95	25.00	.00	.00	-50.00	.00	.00	.00	.00	2.00	.95	.95
54	SWATHER	12.36	.00	.00	-150.00	.00	.00	.00	.00	2.00	.45	.75
55	BALER	25.00	.00	.00	.00	.00	.00	.00	.00	.00	.00	.00
56	PNUT DIG	20.00	.50	20.00	180.00	.00	.00	.00	.00	1.00	.95	.00
57	SHREDDER	21.87	.00	.00	-75.00	.00	.00	.00	.00	.00	.00	.00
58	BURNED	3.00	.00	.00	-10.00	.00	.00	.00	.00	2.00	.00	.00
59	CLEARCUT	25.00	.00	.00	.00	.00	.00	.00	.00	1.00	1.00	.76
65	GRAZE1	3.00	.00	.00	-50.00	.00	.00	.00	.00	2.00	.15	.90
66	GRAZE2	3.00	.00	.00	-150.00	.00	.00	.00	.00	2.00	.15	.20
75	BDIKE100	15.00	.70	10.00	40.00	100.00	1.00	100.00	10.00	-1.00	.00	.00
76	BDIKE300	15.00	.70	10.00	40.00	100.00	1.00	300.00	10.00	-1.00	.00	.00
77	RMV-DIKE	15.00	.70	10.00	40.00	100.00	1.00	.00	.00	-2.00	.00	.00

Table V.1.--Continued.
 EPIC tillage parameters

(1) Abbreviated names of farm machinery and operations:

LISTRPLT	=	Lister planter
ROW PLT	=	Row planter
PLANT DR	=	Drill planter
TRSPLANT	=	Transplanter - trees
SPREADER	=	Fertilizer spreader
SPRAYER	=	Pesticide sprayer
ANHYD AP	=	Anhydrous ammonia applicator
LISTER	=	Lister
DISK BED	=	Disk bedder
ROWBUILD	=	Row builder for sugar cane
CULTPACK	=	Culti-packer
ROW CULT	=	Row cultivator
FLD CULT	=	Field cultivator
ROT HOE	=	Rotary hoe
ROD WEED	=	Rod weeder
SWEEP	=	Sweep
NOBLE PL	=	Noble plow
SPIK HAR	=	Spike harrow
SAND F	=	Sand fighter - wind erosion control
MB PLOW	=	Moldboard plow
TAN DISK	=	Tandom disk
PT-CHS	=	Point chisel
TWPT-CHS	=	Twisted point chisel
SWP-CHS	=	Sweep chisel
OFFSET-D	=	Offset disk
SUBSOIL	=	Subsoil - Deep tillage device
KILL	=	Kills crop
CHISEL K	=	Chisels and kills crop
MB PLW K	=	Moldboard plows and kills crop
OFFSET K	=	Offset disks and kills crop
HARV1.95	=	Harvests with 95% efficiency - kills crop
HARV2.95	=	Harvests with 95% efficiency - does not kill crop
HARVOR75	=	Harvests with 95% efficiency - does not kill crop Harvest index override 75% - used for forage crop
HARVOR95	=	Harvests with 95% efficiency - does not kill crop Harvest index override 95% - used for forage crop
SWATHER	=	Swather - harvests - does not kill crop
BALER	=	Baler
PNUT DIG	=	Peanut digger
SHREDDER	=	Shredder
BURNED	=	Burning operation - does not kill crop
CLEARCUT	=	Clear cut for trees
GRAZE1	=	Cattle grazing - 90% harvest index
GRAZE2	=	Cattle grazing - 20% harvest index
BDIKE100	=	Implement which builds 100-mm furrow dikes
BDIKE300	=	Implement which builds 300-mm furrow dikes
RMV-DIKE	=	Removes furrow dikes

(2) See table VII.4 for definition of variables.

APPENDIX VI: WATER EROSION

Water Erosion Control Practice Factors

In general, whenever sloping soil is to be cultivated and exposed to erosive rains, the protection offered by sod or close-growing crops in the system needs to be supported by practices that will slow the runoff water and thus reduce the amount of soil it can carry. The most important of these supporting cropland practices are contour tillage, stripcropping on the contour, and terrace systems. Stabilized waterways for the disposal of excess rainfall are a necessary part of each of these practices. By definition, factor P in the USLE is the ratio of soil loss with a specific support practice to the corresponding loss with up-and-down-slope culture. Improved tillage practices, sod-based rotations, fertility treatments, and greater quantities of crop residues left on the field contribute materially to erosion control and frequently provide the major control in a farmer's field. However, these are considered conservation cropping and management practices, and the benefits derived from them are included in C.

Table VI.1.a.
P values and slope-length limits for contouring

Land slope (percent)	P value	Maximum length ¹ (feet)
1 to 2	0.60	400
3 to 5	0.50	300
6 to 8	0.50	200
9 to 12	0.60	120
13 to 16	0.70	80
17 to 20	0.80	60
21 to 25	0.90	50

¹ Limit may be increased by 25% if residue cover after crop seedlings will regularly exceed 50%.

Taken from Wischmeier and Smith (1978)

Table VI.1.b.
P values for contour-farmed terraced fields¹

Land slope (percent)	Farm planning		Computing sediment yield ³	
	Contour factor ²	Stripcrop factor	Graded channels and outlets	Steep backslope underground outlets
1 to 2	0.60	0.30	0.12	0.05
3 to 8	.50	.25	.10	.05
9 to 12	.60	.30	.12	.05
13 to 16	.70	.35	.14	.05
17 to 20	.80	.40	.16	.06
21 to 25	.90	.45	.18	.06

¹ Slope length is the horizontal terrace interval. The listed values are for contour farming. No additional contouring factor is used in the computation.

² Use these values for control if interterrace erosion within specified soil loss tolerances.

³ These values include entrapment efficiency and are used for control of offsite sediment within limits and for estimating the field's contribution to watershed sediment yield.

Taken from Wischmeier and Smith (1978)

Table VI.1.c.
P values, maximum strip widths, and slope-length limits for contour stripcropping

Land slope (percent)	P values ¹			Strip width ² (feet)	Maximum length (feet)
	A	B	C		
1 to 2	0.30	0.45	0.60	130	800
3 to 5	.25	.38	.50	100	600
6 to 8	.25	.38	.50	100	400
9 to 12	.30	.45	.60	80	240
13 to 16	.35	.52	.70	80	160
17 to 20	.40	.60	.80	60	120
21 to 25	.45	.68	.90	50	100

¹ P values:

A--For 4-year rotation of row crop, small grain with meadow seeding, and 2 years of meadow. A second row crop can replace the small grain if meadow is established in it.

B--For 4-year rotation of 2-year row crop, winter grain with meadow seeding, and 1-year meadow.

C--For alternate strips of row crop and small grain.

² Adjust strip-width limit, generally downward, to accommodate widths of farm equipment.

Taken from Wischmeier and Smith (1978)

APPENDIX VII: DESCRIPTION OF EPIC INPUT DATA

Table VII.1.
Basic EPIC-user-supplied data set

Information inputted at each read statement	Format	Line numbers	Variables	Definitions	Units	Typical range	Where information is obtained
1. Title (information describing simulation to be performed)	20A4	1-3	TITLE		---	---	User supplies
2. Program control codes	20I4	4	NBYR IYR IBM IDM IPD	Simulation duration Beginning year of simulation Month simulation begins Day of month simulation begins Output print code N1 for annual printout N2 annual with soil table N3 monthly N4 monthly with soil table at end of each year N5 monthly with soil table at harvest K6 daily K7 daily soil table only K8 daily soil table only during growing season K9 daily during growing season	yr --- --- --- ---	1-100 1-2000 1-12 1-31 1-209	User specifies User specifies User specifies User specifies User specifies
			NGN	ID number of weather variables inputted (all other variables are generated). Rain = 1, Temp = 2, Rad = 3, Wind speed = 4, Rel Hum = 5. If any variables are input, rain is included. It is not necessary to specify ID = 1 unless rain is the only input variable. Number times random number generator cycles before simulation begins	---	0-5432	User specifies
			IGN		---	0-100	User specifies

Table VII.1.--Continued.
Basic EPIC-user-supplied data set

Information inputted at each read statement	Format	Line numbers	Variables	Definitions	Units	Typical range	Where information is obtained			
3. General data	10F8.3	5-6	DA	Drainage area	ha	0.1-100	User specifics Table II.1			
			CN2	Runoff curve number	---	30-95	User supplies			
			CHL	Distance along channel from outlet to most distant point on watershed	Km	.05-5				
			CHS	Average channel slope	m m ⁻¹	.0002-0.5	User supplies Table II.2			
			CHN	Channel roughness factor (Manning's n)	---	.01-2	User supplies Table II.2			
			SN	Surface roughness factor (Manning's n)	---	.01-3	User specifics			
			APM	Peak runoff-rate/rainfall-energy adjustment factor	---	.05-2	User specifics			
			YLT	Latitude of watershed	degrees	-90-90	User specifics			
			ELEV ²	Average watershed elevation	m	0-5000	User specifics			
			SNO	Water content of snow on ground at start of simulation	mm	0-100	User specifics			
			RCN	Average concentration of nitrogen in rainfall	g m ⁻³	.5-1.5	User supplies			
			RTN	Number of years of cultivation before simulation starts	yr	0-1000	User specifics			
			4. Water erosion data	3F8.3	7	SL	Slope length	m	10-150	User supplies
						S	Number before decimal specifies water erosion during equation (0 = MUSLE, 1 = A0F, 2 = USLE). Number after decimal is slope steepness.	m m ⁻¹	.0001-0.5	User supplies
5. Weather data	5F8.3	8	PEC	Erosion control practice factor	---	0.0-10.	Table VI.1			
			TP5	TP-40 10-year frequency 0.5-hour rainfall	mm	5-150	Fig. I.1			
			TP6	TP-40 10-year frequency 6-hour rainfall	mm	25-200	Fig. I.2			
			TP24	Number years of maximum monthly 0.5-hour rainfall record	yr	7-10	Tables I.1-I.2			
			BTA	Coefficient used to estimate wet-dry probabilities, given monthly number of wet days	---	0-1	User specifics			
			EXPK ^{4,9}	Power used to modify exponential rainfall amount distribution	---	0.5-2.0	User specifics			
			OBMX	Average monthly maximum air temperature	C	-10-42	Tables I.1-I.2			
			OBMN	Average monthly minimum air temperature	C	-30-30	Tables I.1-I.2			
			SDTMX ^{3,8}	Monthly standard deviation maximum daily air temperature	C	1-15	Tables I.1-I.2			
			SDTMN ^{3,8}	Monthly standard deviation minimum daily air temperature	C	1-15	Tables I.1-I.2			
			SMY	Average monthly precipitation	mm	0-500	Tables I.1-I.2			
			RST(2) ^{4,1}	Monthly standard deviation of daily precipitation	mm	0.25-50	Tables I.1-I.2			
			RST(3) ^{4,1}	Monthly skew coefficient for daily precipitation	---	1-7	Tables I.1-I.2			
			PRW1 ^{5,4}	Monthly probability of wet day after dry day	---	0.001-0.95	Tables I.1-I.2			
PRW2 ^{5,4}	Monthly probability of wet day after wet day	---	0.01-0.95	Tables I.1-I.2						
WVL ⁶	Average number days of rain per month	d	0-30	Tables I.1-I.2						
WI	Monthly maximum 0.5-h rainfall for period of record (TP24)	mm	0-125	Tables I.1-I.2						
OBSL	Monthly average daily solar radiation or ly	MJ m ⁻²	20-750	Tables I.1-I.2						
RH ²	Monthly average relative humidity	---	0-1	Tables I.1-I.2						

Table VII.1.--Continued.
Basic EPIC-user-supplied data set

Information inputted at each read statement	Format	Line numbers	Variables	Definitions	Units	Typical range	Where information is obtained			
6. Wind erosion data	4F8.3	22	FL ⁷	Field length	km	0-4	User specifies			
			FW ⁷	Field width	km	0.05-2	User specifies			
			ANG ⁷	Clockwise angle of field length from north	degrees	0-360	User specifies			
			STD ¹	Standing dead crop residue	t ha ⁻¹	0-100	User specifies			
			SWV ^{2&7}	Power of modified exponential distribution of wind speed	---	0.3-0.6	User specifies			
			CF ⁷	Climatic factor	---	1-1000	Tables I.3-I.4			
			ACW ⁷	Wind erosion adjustment factor	---	0-10	User specifies			
			WVL ^{2&7}	Average monthly wind velocity	m s ⁻¹	0.5-10	Tables I.3-I.4			
			DIR(1) ⁷	N wind during each month	%	0-50	Tables I.3-I.4			
			DIR(2) ⁷	NNE wind during each month	%	0-50	Tables I.3-I.4			
			DIR(3) ⁷	NE wind during each month	%	0-50	Tables I.3-I.4			
		
			.	.	.	DIR(16) ⁷	NNW wind during each month	%	0-50	Tables I.3-I.4
7. Soil data	2F8.3	41	SALB	Soil albedo	---	0.05-0.20	Tables IV.1-IV.2			
			TSLA ¹	Maximum number of soil layers	---	3-10	User specifies			
			ZQT ¹	Minimum thickness of maximum soil layer. Splitting stops when ZQT is reached.	m	0.01-0.1	User specifies			
			ZF ¹	Minimum soil profile thickness. Simulation stops when ZF is reached.	m	0.1-1.0	User specifies			
			FFC ¹	Initial soil water content--fraction of field capacity	---	0-1	User specifies			
			WTMN ¹	Minimum depth to water table	m	0-2	User specifies			
			WTMX ¹	Maximum depth to water table	m	0.5-3	User specifies			
			WTBL ¹	Initial depth to water table	m	0-3	User specifies			
			XIDS ¹	Soil weather code (0 for calcareous soils and noncalcareous without weathering information; 1 for noncalcareous slightly weathered; 2 for noncalcareous moderately weathered; 3 for noncalcareous highly weathered; 4 for inputting P sorption ratios)	---	0-4	User specifies			

Table VII.1.--Continued.
Basic EPIC-user-supplied data set

Information inputted at each read statement	Format	Line numbers	Variables	Definitions	Units	Typical range	Where information is obtained
7. Soil data (continued)	10F8.3	42-62	Z BD U ¹ FC ¹ SAN SIL WN ¹ PH SMB ¹ CBN CAC CEC ¹ ROK ¹ WNO ³ ¹ AP ¹ RSD ¹ BDD ¹ PSP ¹ SC ¹ RT ¹ WP ¹	Depth from the surface to the bottom of the soil layer Bulk density of the soil layer (33 kPa) Wilting point (1500 kPa for many soils) Field capacity (33 kPa for many soils) Sand content Silt content Organic N concentration Soil pH Sum of bases Organic carbon Calcium carbonate Cation exchange capacity Coarse fragment content Nitrate concentration Labile P concentration Crop residue Bulk density (oven dry) Phosphorus sorption ratio Saturated conductivity Subsurface flow travel time Organic P concentration	m ⁻³ t m ⁻³ m m ⁻¹ m m ⁻¹ % % g t ⁻¹ --- cmol kg ⁻¹ % % cmol kg ⁻¹ % % cmol kg ⁻¹ % g t ⁻¹ g t ⁻¹ t ha ⁻¹ t m ⁻³ --- mm h ⁻¹ d g t ⁻¹	.01-3 0.25-2.3 0.01-0.65 0.05-0.8 0-100 0-100 20-5000 4-9 0-150 0.05-5.0 0-100 0-150 0-30 0-30 0-50 0-15 0-2.5 0-0.75 0-25. 0-1000 10-2000	User specifics Tables IV.1-IV.2 Tables IV.1-IV.2 Tables IV.1-IV.2 Tables IV.1-IV.2 Tables IV.1-IV.2 Tables IV.1-IV.2 Tables IV.1-IV.2 Tables IV.1-IV.2 Tables IV.1-IV.2 Tables IV.1-IV.2 Tables IV.1-IV.2 Tables IV.1-IV.2 User specifics User specifics User specifics User specifics User specifics User specifics User specifics User specifics User specifics
8. Management information	7I4	63	NRO IRR IRI IFA LM IFD IDR	Crop rotation duration Irrigation code (0 for dryland; 1 for sprinkler; 2 for furrow) Minimum application interval for automatic irrigation For manual irrigation--0 applies volume specified by inputted; 2 applies the lower volume between volume inputted and volume needed to fill soil to field capacity Minimum fertilizer application interval for automatic option Liming code -- 0 applies lime automatically; 1 applies no lime Furrow dike code (0 for no dikes; 1 for furrow dike system Drainage code (0 for no drainage; layer number that contains drainage system)	yr --- d --- d --- --- --- ---	1-10 0-2 1-200 0-2 0-200 0-1 0-1 0-10	User specifics User specifics User specifics User specifics User specifics User specifics User specifics User specifics User specifics

Table VII.1.--Continued.
Basic EPIC-user-supplied data set

Information inputted at each read statement	Format	Line numbers	Variables	Definitions	Units	Typical range	Where information is obtained
8. Management information (continued)		64					
Operation variables							
	10F8.3		BIR	Water stress factor to trigger automatic irrigation	---	0.2-0.95	User specifies
			EFI	Irrigation runoff ratio	---	0-0.5	User specifies
			VIMX ¹	Maximum annual irrigation volume allowed for each crop	mm	10-1000	User specifies
			ARMN ¹	Minimum single application volume allowed for automatic irrigation	mm	1-100	User specifies
			ARMX ¹	Maximum single application volume allowed for automatic irrigation	mm	10-300	User specifies
			BFT	N stress factor to trigger automatic fertilizer	---	0.1-0.95	User specifies
			FNP ¹	Fraction of maximum N fertilizer potentially applied at planting	---	0-1	User specifies
			FMX ¹	Maximum annual N fertilizer application for a crop	kg ha ¹	5-500	User specifies
			DRT	Time required for drainage system to eliminate plant stress caused for poor aeration	d	0.5-10.0	User specifies
			FDSF	Fraction of furrow dike volume available for water storage	---	0.1-1.0	User specifies
Operation schedule							
Irrigation							
214,F8.3		65 -	MO	Month of irrigation application	---	1-12	User specifies
(NIR = # irrigation applications; last line is blank)		NIR + 66	IDA	Day of month of irrigation application	---	1-31	User specifies
Fertilizer			VIRR	Irrigation volume	mm	1-300	User specifies
214,3F8.3		NIR +					
(input only if BFT = 0);		67 -	MO	Month of fertilizer application	---	1-12	User specifies
NFT = # fertilizer applications; last line is blank		NFT + 68	IDA	Day of month of fertilizer application	---	1-31	User specifies
			FN	Nitrogen fertilizer applied	kg ha ⁻¹	0-400	User specifies
			FP	Phosphorus fertilizer applied	kg ha ⁻¹	0-400	User specifies
			FDP	Depth of fertilizer placement	mm	0-100	User specifies

Table VII.1.--Continued.
Basic EPIC-user-supplied data set

Information inputted at each read statement	Format	Line numbers	Variables	Definitions	Units	Typical range	Where information is obtained
8. Management information (continued)							
Operation schedule		NFT + 69	MT	Month of tillage operation	---	1-12	User specifies
Tillage			IT	Day of month of tillage	---	1-31	User specifies
5I4,2F8.3 (NTL = # tillage operations; last line is blank)		NTL + 70	LT	Tillage operation identification number	---	1-100	Table V.1
			KDC	Crop identification number (used only at planting)		1-100	Table III.1
			J2	For tree crops only. At planting J2 = time to maturity. At harvest, J2 = time between planting and harvest.	yr	10-100	User specifies
			PHU ¹	Potential heat units	C	500-3000	User specifies
			CN2 ¹	Runoff curve number	---	30-95	User specifies
9. Daily weather data	16X, F4.0, 2F6.1, 3F6.3	365(NBYR)	RA	Solar radiation or ly	MJ m ⁻²	0-800	User supplies
			TMX	Maximum temperature	C	-20-999	User supplies
			TMN	Minimum temperature	C	-50-999	User supplies
			R	Precipitation	mm	0-999	User supplies
			RHD	Relative humidity	---	0.0-0.99	User supplies
			WIND	Wind	m s ⁻¹	0.0-25	User supplies

¹Blank if unknown.

²Blank if Priestley-Taylor method is used to estimate potential evaporation.

³Temperature extremes may be substituted.

⁴Blank if daily rainfall is input.

⁵Blank if unknown and averaged number days of rain per month is available.

⁶Blank if rainfall is generated and wet-dry probabilities are available.

⁷Blank if wind erosion is not estimated.

⁸Blank if daily temperature is input.

⁹Blank if rainfall standard deviation and skew coefficient are available.

Table VII.2.
Output selection

Information inputted at each read statement	Format	Line numbers	Variables	Definitions	Units	Typical range	Where information is obtained
Output selection codes	20I4	1-2	KA	Identification numbers for variables, expressed as accumulations and averages (blank for standard output; -1 omits output of accumulations and averages; or up to 30 variables may be outputted by inputting KA numbers)	---	1-58	User specifies
		3	KS	Identification numbers of state variables (blank for standard output; -1 omits output of state variables; or up to 10 variables may be outputted by inputting KS numbers)		11-58	User specifies
		4-5	KD	Identification numbers of daily output variables (blank for standard output or up to 34 variables may be outputted by inputting KD numbers)		1-65	User specifies

Table VII.3.
Experimental parameters and economic data

Information inputted at each read statement	Format	Line numbers	Variables	Definitions	Units	Typical range	Where information is obtained
Experimental parameters	2F8.3	1-14	SCR(1,2)	Two points on S-shaped curves (used in model development and modification only). Numbers before decimal are percent of x axis. Numbers after decimal are fractions of y axis.	%	0-100 0-1	User specifies User specifies
	12F6.2	15-16	PARM	Model parameters used for experimental purposes only	various	0-1000	User specifies
Economic data	6F8.2	17	COIR COL CON COP COPC COHC	Irrigation water cost Lime cost Nitrogen fertilizer cost Phosphorus fertilizer cost Pesticide cost Herbicide cost	$\text{\$ m}^{-3}$ $\text{\$ t}^{-1}$ $\text{\$ kg}^{-1}$ $\text{\$ kg}^{-1}$ $\text{\$ ha}^{-1}$ $\text{\$ ha}^{-1}$	0.1-1 0.01-100 0.01-1 0.01-1 0.5-100 0.5-100	User specifies User specifies User specifies User specifies User specifies User specifies

Table VII.5.
Crop parameters

Information inputted at each read statement	Format	Line numbers	Variables	Definitions	Units	Typical range	Where information is obtained
Crop data (used only to expand or modify crop table)	4X,A4, 9F8.3/ 10F8.3	3	CPNM	Crop name (up to 4 characters beginning in column 5)	---	---	Table III.1
			WA	Biomass energy ratio	t ha ⁻¹ MJ ⁻¹	---	Table III.1
			HI	Harvest index	kg kg ⁻¹	0.01-0.95	Table III.1
			TB	Optimal temperature for plant growth	°C	10-30	Table III.1
			TG	Minimum temperature for plant growth	°C	0-12	Table III.1
			DMLA	Maximum potential leaf area index	---	0.5-10	Table III.1
			DLAI	Fraction of growing season when leaf area starts declining	---	0.4-0.99	Table III.1
			DLAP(1,2)	Two points on optimal leaf area development curve. Numbers before decimal are percent of growing season. Numbers after decimal are fractions of maximum leaf area index.	%	0-100	Table III.1
			---	---	---	0-1	Table III.1
			RLAD	Leaf area index decline rate parameter	---	---	Table III.1
			RBMD	Biomass-energy ratio decline rate parameter	---	---	Table III.1
			ALT	Aluminum tolerance index (1 = sensitive; 5-tolerant)	---	---	Table III.1
			CAF	Critical aeration factor	---	0.75-1.0	Table III.1
			SDW	Seeding rate	kg ha ⁻¹	3-100	Table III.1
			HMX	Maximum crop height	m	0.1-3	Table III.1
			RDMX	Maximum root depth	m	0.5-3	Table III.1
			CVM	Minimum value of C factor for water erosion	---	0.001-0.5	Table III.1
			CNY	Fraction of nitrogen in yield	kg kg ⁻¹	0.015-0.065	Table III.1
			CPY	Fraction of phosphorus in yield	kg kg ⁻¹	0.002-0.0095	Table III.1
			WSYF	Water stress--crop yield factor	---	0-0.2	Table III.1
PST	Pest (insects, weeds, and disease) factor	---	0.05-1.0	Table III.1			
COSD	Seed cost	\$ kg ⁻¹	---	Table III.1			
PRY	Price for yield	\$ t	0.1-100	Table III.1			
WCY	Fraction water in yield	---	10-1000.	Table III.1			
BN1	Nitrogen uptake parameter (N fraction in plant at emergence)	---	0.05-0.80	Table III.1			
BN2	Nitrogen uptake parameter (N fraction in plant at maturity)	---	0.04-0.06	Table III.1			
BN3	Nitrogen uptake parameter (N fraction in plant at maturity)	---	0.015-0.03	Table III.1			
BP1	Phosphorus uptake parameter (P fraction in plant at emergence)	---	0.01-0.27	Table III.1			
BP2	Phosphorus uptake parameter (P fraction in plant at maturity)	---	0.006-0.009	Table III.1			
BP3	Phosphorus uptake parameter (P fraction in plant at maturity)	---	0.002-0.005	Table III.1			
---	---	---	0.0015-0.0035	Table III.1			

Table VII.5.--Continued.
Crop parameters

Information inputted at each read statement	Format	Line numbers	Variables	Definitions	Units	Typical range	Where information is obtained
			BW ₁	Wind erosion factor for standing live biomass	---	0.4-3.5	Table III.1
			BW ₂	Wind erosion factor for standing dead crop residue	---	0.4-3.5	Table III.1
			BW ₃	Wind erosion factor for flat residue	---	0.2-3.5	Table III.1
			IDC	Crop category number (1-warm season annual legume; 2-cold season annual legume; 3-perennial legume; 4-warm season annual; 5-cold season annual; 6-perennial; 7-trees)	---	1-7	Table III.1
			FRST(1,2)	Two points on frost damage curve. Numbers before decimal are minimum daily temperature °C. Numbers after decimal are fractions of yield loss for given minimum temperature.	°C	-30-0	Table III.1
					---	0-1	Table III.1

Table VII.6.
Multiperiod simulation controls

Information inputted at each read statement	Format	Line numbers	Variables	Definitions	Units	Typical range	Where information is obtained
Simulation durations and erosion variables	I4,2F8.3 (last line limit must be blank)	No	NBYR PEC ACW	Simulation duration Erosion control practice factor Wind erosion adjustment factor	yr --- ---	1-100 0-10 0-10	User specifies User specifies User specifies

APPENDIX VIII: EPIC INPUT DATA FORMS

Table VIII.1.
Data assembly forms

***** FORM 1 *****
EPIC DATA ASSEMBLY FORM

1.1 Title

[_____]* _____

2.1 Program control codes

2.1.1 Number of years of simulation _____

2.1.2 Starting date - Year _____

2.1.3 - Month _____

2.1.4 - Day _____

2.1.5 Output print code _____

2.1.6 Printout interval¹ _____

2.1.7 Weather code _____

2.1.8 Number of times generator cycles¹ _____

¹ May be left blank or zero if unknown.

* The first 8 characters of this line are used by EPIC in the EPICOUT file. An 8-character file name works well for this entry to reference printouts to their corresponding data sets.

***** FORM 2 *****
EPIC DATA ASSEMBLY FORM

3.1 General data

- 3.1.1 Drainage area _____
- 3.1.2 Runoff curve number _____
- 3.1.3 Channel length _____
- 3.1.4 Average channel slope _____
- 3.1.5 Manning's n--Channel roughness factor _____
- 3.1.6 Manning's n--Surface roughness factor _____
- 3.1.7 Peak runoff-rate rainfall-energy adjustment factor _____
- 3.1.8 Latitude of watershed _____
- 3.1.9 Average elevation of watershed² _____
- 3.1.10 Water content of snow on ground at start of simulation _____
- 3.1.11 Average concentration of nitrogen in rainfall _____
- 3.1.12 Number of years of cultivation before simulation starts _____

4.1 Water erosion data

- 4.1.1 Slope length _____
- 4.1.2 Slope steepness _____
- 4.1.3 Water erosion equation¹ _____
- 4.1.4 Erosion control practice _____

5.1 Weather data

Enter weather access number (table 1.2) to load from file and skip to section 6.1 OR enter zero and input below.

- 5.1.1 TP-40 10-year frequency 0.5-hour rainfall _____
- 5.1.2 TP-40 10-year frequency 6.0-hour rainfall _____
- 5.1.3 Number years of maximum monthly 0.5-hour rainfall record _____
- 5.1.4 Coefficient to estimate wet-dry probabilities given number of wet days^{6,4} _____
- 5.1.5 Power used to modify exponential rainfall amount distribution^{4,9} _____

¹ May be left blank or zero if unknown.

² Blank if Priestley-Taylor method is used to estimate potential evaporation.

⁴ May be left blank or zero if daily rainfall is inputted (ref. 2.1.7 > 0).

⁶ Blank or zero if rainfall is generated and wet-dry probabilities are available.

⁹ Blank if rainfall standard deviation and skew coefficient are available.

***** FORM 3 *****
EPIC DATA ASSEMBLY FORM

5.2.1 Average monthly maximum air temperature

5.2.2 Average monthly minimum air temperature

5.2.3 Monthly standard deviation maximum air temperature^{3,8}

5.2.4 Monthly standard deviation minimum air temperature^{3,8}

5.2.5 Average monthly precipitation

5.2.6 Monthly standard deviation of daily precipitation^{4,1}

5.2.7 Monthly skew coefficient for daily precipitation^{4,1}

5.3.1 Monthly probability of wet day after dry day^{4,5}

5.3.2 Monthly probability of wet day after wet day^{4,5}

5.3.3 Average number of days of rain per month⁶

5.3.4 Monthly maximum 0.5 hour-rainfall for period of record (TP24)

5.3.5 Monthly average daily solar radiation

5.3.6 Monthly average relative humidity²

¹ May be left blank or zero if unknown.

² Blank if Priestley-Taylor method is used to estimate potential evaporation.

³ Temperature extremes may be substituted.

⁴ May be left blank or zero if daily rainfall is inputted (ref. 2.1.7 > 0).

⁵ Blank or zero if unknown and average number of days of rain per month is available.

⁶ Blank or zero if rainfall is generated and wet-dry probabilities are available.

⁸ Blank or zero if daily temperature is inputted (ref. 2.1.7 > 1).

***** FORM 4 *****
EPIC DATA ASSEMBLY FORM

6.1 Wind erosion data

Enter wind access number (table I.4) to load from file and skip to section 7.1 or enter zero and input below.

- 6.1.1 Field length⁷ _____
- 6.1.2 Field width⁷ _____
- 6.1.3 Clockwise angle of field from north⁷ _____
- 6.1.4 Standing dead crop residue¹ _____

6.2 Wind data

- 6.2.1 Power of modified exponential distribution of wind speed^{2&7} _____
- 6.2.2 Climatic factor⁷ _____
- 6.2.3 Wind erosion adjustment factor⁷ _____
- 6.3.1 Average monthly wind velocity^{2&7} _____

6.3.2 N wind during each month⁷

6.3.3 NNE wind during each month⁷

6.3.4 NE wind during each month⁷

6.3.5 ENE wind during each month⁷

6.3.6 E wind during each month⁷

6.3.7 ESE wind during each month⁷

6.3.8 SE wind during each month⁷

6.3.9 SSE wind during each month⁷

¹ May be left blank or zero if unknown.
² Blank if Priestley-Taylor method is used to estimate potential evaporation.
⁷ Blank or zero if wind erosion is not estimated.

***** FORM 5 *****
EPIC DATA ASSEMBLY FORM

6.4.1 S wind during each month⁷

6.4.2 SSW wind during each month⁷

6.4.3 SW wind during each month⁷

6.4.4 WSW wind during each month⁷

6.4.5 W wind during each month⁷

6.4.6 WNW wind during each month⁷

6.4.7 NW wind during each month⁷

6.4.8 NNW wind during each month⁷

⁷ Blank or zero if wind erosion is not estimated.

***** FORM 6 *****
EPIC DATA ASSEMBLY FORM

7.1 Soil data

Enter soil access number or name to load from file and skip to section 10.1 or enter zero and input below.

7.1.1 Soil albedo

7.1.2 Maximum number of soil layers¹

7.1.3 Minimum thickness of maximum layer¹

7.1.4 Minimum soil profile thickness¹

7.1.5 Initial soil water content-fraction of field capacity¹

7.1.6 Minimum depth to water table¹

7.1.7 Maximum depth to water table¹

7.1.8 Initial depth to water table¹

7.1.9 Soil weather code¹

7.2.1 Depth from the surface to the bottom of the soil layer

7.2.2 Bulk density of the soil layer

7.2.3 Wilting point¹

7.2.4 Field capacity¹

7.2.5 Sand content

7.2.6 Silt content

7.2.7 Organic N concentration¹

7.2.8 Soil pH

¹ May be left blank or zero if unknown.

***** FORM 7 *****
EPIC DATA ASSEMBLY FORM

7.3.1	Sum of bases ¹	_____	_____	_____	_____	_____	_____	_____
7.3.2	Organic carbon	_____	_____	_____	_____	_____	_____	_____
7.3.3	Calcium carbonate	_____	_____	_____	_____	_____	_____	_____
7.3.4	Cation exchange capacity ¹	_____	_____	_____	_____	_____	_____	_____
7.3.5	Coarse fragment content ¹	_____	_____	_____	_____	_____	_____	_____
7.3.6	Nitrate concentration ¹	_____	_____	_____	_____	_____	_____	_____
7.3.7	Labile P concentration ¹	_____	_____	_____	_____	_____	_____	_____
7.3.8	Crop residue ¹	_____	_____	_____	_____	_____	_____	_____
7.4.1	Bulk density (oven dry) ¹	_____	_____	_____	_____	_____	_____	_____
7.4.2	Phosphorus sorption ratio ¹	_____	_____	_____	_____	_____	_____	_____
7.4.3	Saturated conductivity ¹	_____	_____	_____	_____	_____	_____	_____
7.4.4	Subsurface flow travel time ¹	_____	_____	_____	_____	_____	_____	_____
7.4.5	Organic P concentration ¹	_____	_____	_____	_____	_____	_____	_____

¹ May be left blank or zero if unknown.

***** FORM 8 *****
EPIC DATA ASSEMBLY FORM

8.1 Management information - operation codes

- 8.1.1 Crop rotation duration _____
- 8.1.2 Irrigation code¹ _____
- 8.1.3 Minimum application interval for automatic irrigation¹ _____
- 8.1.4 Minimum fertilizer application interval for automatic fertilizer¹ _____
- 8.1.5 Liming code¹ _____
- 8.1.6 Furrow dike code¹ _____
- 8.1.7 Drainage code¹ _____

8.2 Management information - operation variables

- 8.2.1 Water stress factor to trigger automatic irrigation _____
- 8.2.2 Irrigation runoff ratio _____
- 8.2.3 Maximum annual irrigation volume allowed for each crop¹ _____
- 8.2.4 Minimum single application volume automatic irrigation¹ _____
- 8.2.5 Maximum single application volume automatic irrigation¹ _____
- 8.2.6 N stress factor to trigger automatic fertilizer _____
- 8.2.7 Fraction of maximum N fertilizer applied at planting¹ _____
- 8.2.8 Maximum annual N fertilizer application for a crop¹ _____
- 8.2.9 Time required for drainage system to reduce stress _____
- 8.2.10 Fraction of furrow dike volume available for storage _____

¹ May be left blank or zero if unknown.

***** FORM 9 *****
EPIC DATA ASSEMBLY FORM

8.1 Management information - Irrigation/Fertilizer schedule
 (one for each year of rotation)

Note: Both are not required in order to use one. Irrigation AND/OR Fertilizer may be used.

Irrigation schedule*			Fertilizer schedule**					
	Month	Day	Amount	Month	Day	N amount	P amount	Depth
1	_____	_____	_____	1	_____	_____	_____	_____
2	_____	_____	_____	2	_____	_____	_____	_____
3	_____	_____	_____	3	_____	_____	_____	_____
4	_____	_____	_____	4	_____	_____	_____	_____
5	_____	_____	_____	5	_____	_____	_____	_____
6	_____	_____	_____	6	_____	_____	_____	_____
7	_____	_____	_____	7	_____	_____	_____	_____
8	_____	_____	_____	8	_____	_____	_____	_____
9	_____	_____	_____	9	_____	_____	_____	_____
10	_____	_____	_____	10	_____	_____	_____	_____
11	_____	_____	_____	11	_____	_____	_____	_____
12	_____	_____	_____	12	_____	_____	_____	_____
13	_____	_____	_____	13	_____	_____	_____	_____
14	_____	_____	_____	14	_____	_____	_____	_____
15	_____	_____	_____	15	_____	_____	_____	_____
16	_____	_____	_____	16	_____	_____	_____	_____
17	_____	_____	_____	17	_____	_____	_____	_____
18	_____	_____	_____	18	_____	_____	_____	_____
19	_____	_____	_____	19	_____	_____	_____	_____
20	_____	_____	_____	20	_____	_____	_____	_____

* Inputted only when IFF (ref 8.1.2) is not zero AND BIR (ref 8.2.1) is zero.
 ** Inputted only when BFT (ref. 4.1.14) is zero.

***** FORM 10 *****
EPIC DATA ASSEMBLY FORM

8.1 Management information - Tillage schedule
 (one for each year of rotation)

	Month	Day	Tillage number	Crop number*	Tree code ^{1**}	Heat units ^{1*}
1	_____	_____	_____	_____	_____	_____
2	_____	_____	_____	_____	_____	_____
3	_____	_____	_____	_____	_____	_____
4	_____	_____	_____	_____	_____	_____
5	_____	_____	_____	_____	_____	_____
6	_____	_____	_____	_____	_____	_____
7	_____	_____	_____	_____	_____	_____
8	_____	_____	_____	_____	_____	_____
9	_____	_____	_____	_____	_____	_____
10	_____	_____	_____	_____	_____	_____
11	_____	_____	_____	_____	_____	_____
12	_____	_____	_____	_____	_____	_____
13	_____	_____	_____	_____	_____	_____
14	_____	_____	_____	_____	_____	_____
15	_____	_____	_____	_____	_____	_____
16	_____	_____	_____	_____	_____	_____
17	_____	_____	_____	_____	_____	_____
18	_____	_____	_____	_____	_____	_____
19	_____	_____	_____	_____	_____	_____
20	_____	_____	_____	_____	_____	_____

¹ May be left blank or zero if unknown.

* Only inputted when planting (heat units are optional), zero otherwise.

** Only inputted when growing trees (and then optional), zero otherwise.

***** FORM 11 *****
EPIC DATA ASSEMBLY FORM

9.1 Daily weather file name(s)

Note: This section is only to be completed if you have chosen to input daily weather data where the weather code NGN > 0 AND only if you are using the PC or DEC version of EASE/EPIC. On the mainframe, the weather data will be at the end of the data set and not in a separate file, as on the PC and the VAX.

Enter the complete file names, including directories (if necessary):
100 files maximum (only 20 shown here)
70 characters maximum in each file name

9.1.1	_____
9.1.2	_____
9.1.3	_____
9.1.4	_____
9.1.5	_____
9.1.6	_____
9.1.7	_____
9.1.8	_____
9.1.9	_____
9.1.10	_____
9.1.11	_____
9.1.12	_____
9.1.13	_____
9.1.14	_____
9.1.15	_____
9.1.16	_____
9.1.17	_____
9.1.18	_____
9.1.19	_____
9.1.20	_____

***** FORM 12 *****
EPIC DATA ASSEMBLY FORM

10.1 Output selection codes in PRNT file

10.1.1 Output variable id numbers for accumulated and average values:

_____	_____	_____	_____	_____	_____	_____	_____	_____	_____
_____	_____	_____	_____	_____	_____	_____	_____	_____	_____
_____	_____	_____	_____	_____	_____	_____	_____	_____	_____

10.1.2 Output variable id numbers for state values:

_____	_____	_____	_____	_____	_____	_____	_____	_____	_____
-------	-------	-------	-------	-------	-------	-------	-------	-------	-------

10.1.3 Daily output variable id numbers for accumulated OR average values:

_____	_____	_____	_____	_____	_____	_____	_____	_____	_____
_____	_____	_____	_____	_____	_____	_____	_____	_____	_____
_____	_____	_____	_____	_____	_____	_____	_____	_____	_____

11.1 Economic data in PARM file

- 11.1.1 Irrigation water cost _____
- 11.1.2 Lime cost _____
- 11.1.3 Nitrogen fertilizer cost _____
- 11.1.4 Phosphorus fertilizer cost _____
- 11.1.5 Pesticide cost _____
- 11.1.6 Herbicide cost _____

***** FORM 13 *****
EPIC DATA ASSEMBLY FORM

12.1 Equipment/tillage operation parameter data in TILL file

- 12.1.1 Equipment/tillage operation name (8 characters) _____
- 12.1.2 Cost of operation _____
- 12.1.3 Mixing efficiency of operation _____
- 12.1.4 Surface random roughness created by operation _____
- 12.1.5 Tillage depth _____
- 12.1.6 Ridge height _____
- 12.1.7 Ridge interval _____
- 12.1.8 Furrow dike height¹ _____
- 12.1.9 Furrow dike interval¹ _____
- 12.1.10 Operation code _____
- 12.1.11 Harvest efficiency _____
- 12.1.12 Overrides harvest index of crop _____

¹ May be left blank or zero if unknown.

***** FORM 14 *****
EPIC DATA ASSEMBLY FORM

13.1 Crop parameter data in CROP file

- 13.1.0 Crop name (4 characters) _____
- 13.1.1 Biomass energy ratio _____
- 13.1.2 Harvest index _____
- 13.1.3 Optimal temperature for plant growth _____
- 13.1.4 Minimum temperature for plant growth _____
- 13.1.5 Maximum leaf area index _____
- 13.1.6 Fraction of growing season when LAI starts decline _____
- 13.1.7 First point on optimal LAI development curve (%) _____
- 13.1.8 Fraction LAI development at 13.1.7 percent _____
- 13.1.9 Second point on optimal LAI development curve (%) _____
- 13.1.10 Fraction LAI development at 13.1.9 percent _____
- 13.1.11 LAI decline rate factor _____
- 13.1.12 Biomass/energy decline rate _____
- 13.1.13 Aluminum tolerance index _____
- 13.1.14 Critical labile P concentration _____
- 13.1.15 Critical aeration factor _____

- 13.2.1 Seeding rate _____
- 13.2.2 Maximum crop height _____
- 13.2.3 Maximum root depth _____
- 13.2.4 NOT USED _____
- 13.2.5 Minimum value of C factor for water erosion _____
- 13.2.6 Fraction of nitrogen in yield _____
- 13.2.7 Fraction of phosphorus in yield _____
- 13.2.8 Water-stress/crop-yield factor _____
- 13.2.9 Pest (insect, weeds, and disease) factor _____

***** FORM 15 *****
EPIC DATA ASSEMBLY FORM

- 13.2.10 Seed cost
- 13.2.11 Price for yield _____
- 13.2.12 Fraction of water in yield _____

- 13.3. 1 Nitrogen uptake - N fraction at emergence _____
- 13.3. 2 Nitrogen uptake - N fraction at 0.5 maturity _____
- 13.3. 3 Nitrogen uptake - N fraction at maturity _____
- 13.3. 4 Phosphorus uptake - P fraction at emergence _____
- 13.3.5 Phosphorus uptake - P fraction at 0.5 maturity _____
- 13.3.6 Phosphorus uptake - P fraction at maturity _____
- 13.3.7 Wind erosion factor for standing live biomass _____
- 13.3.8 Wind erosion factor for standing dead crop residue _____
- 13.3.9 Wind erosion factor for flat residue _____
- 13.3.10 Crop category number _____
- 13.3.11 First point on frost damage curve minimum temperature °C _____
- 13.3.12 Fraction of yield lost at above (ref. 13.3.11) temperature _____
- 13.3.13 Second point on frost damage curve minimum temperature °C _____
- 13.3.14 Fraction of yield lost at above (ref. 13.3.13) temperature _____

APPENDIX IX: OUTPUT VARIABLE DEFINITIONS

Table IX.1.
Output variable definitions

AIR	Aeration stress on crop growth (d)
ALPH	0.5-h precipitation/total storm precipitation
AL SAT	Soil aluminum saturation (%)
ALT	Index of crop tolerance to aluminum saturation (1-5; 1 = sensitive, 5 = tolerant)
AOF	Soil loss from water erosion using Onstad-Foster modified USLE ($t\ ha^{-1}$)
AS	Aeration stress factor (0-1)
BD	Moist soil bulk density ($t\ m^{-3}$)
BDD	Dry soil bulk density ($t\ m^{-3}$)
BIOM	Crop biomass (shoot + root) ($t\ ha^{-1}$)
BN1	Normal fraction of N in crop biomass at emergence
BN2	Normal fraction of N in crop biomass at midseason
BN3	Normal fraction of N in crop biomass at maturity
BP	Normal fraction of P in crop biomass at emergence
BP2	Normal fraction of P in crop biomass at midseason
BP3	Normal fraction of P in crop biomass at maturity
BW1	Wind erosion factor for standing live biomass
BW2	Wind erosion factor for standing dead crop residue
BW3	Wind erosion factor for flat residue
C	Average water-erosion/crop-management factor
CACO3	Free soil calcium carbonate (%)
CAF	Critical aeration factor--fraction of soil porosity where poor aeration starts limiting plant growth
CAW	Crop available water (mm)
CEC	Cation exchange capacity ($cmol\ kg^{-1}$)
CF	Wind erosion equation climatic factor
CN	SCS runoff curve number
CN2	SCS runoff curve number for moisture condition 2
CNY	Normal fraction of N in yield ($g\ g^{-1}$)
COSD	Seed cost ($\$ t^{-1}$)

COST	Total production cost (\$)
CPY	Normal fraction of P in yield (g g^{-1})
CVM	Minimum value of water erosion C factor
DAYP	Number of days with precipitation
DAYQ	Number of days with runoff
DKH	Furrow dike height (mm)
DKI	Furrow dike interval (M)
DLAI	Fraction of growing season when leaf area index starts declining
DMLA	Maximum potential leaf area index ($\text{m}^2 \text{m}^{-2}$)
DN	N loss by denitrification (kg ha^{-1})
DP	Depth of tillage (mm)
EI	Rainfall energy factor
EK	Soil erodibility factor for water erosion
ELEV	Elevation of the site (mm)
EP	Transpiration (mm)
ER	Enrichment ratio (nutrient content of sediment/nutrient content of top soil layer)
ET	Evapotranspiration (mm)
EVN	NO_3 moved from top 0.2 m soil to top layer (kg ha^{-1})
FALF	Fall of senescent plant material (t ha^{-1})
FC	Soil water content at field capacity (33 kPa for many soils) (m m^{-1})
FN	Average annual N fertilizer rate (kg ha^{-1})
FP	Average annual P fertilizer rate (kg ha^{-1})
FRS(1,2)	Two points on the frost damage curve. Numbers before decimal are the minimum temperatures ($^{\circ}\text{C}$) and numbers after decimal are the fraction of biomass lost when specified minimum temperature occurs.
HI	Harvest index (crop yield/above ground biomass)
HMN	N mineralized from stable organic matter (kg ha^{-1})
HMX	Maximum crop height (m)
HRLT	Day length (h)
HU	Heat units--average daily temperature minus base temperature of crop ($^{\circ}\text{C}$)

HUM	Stable organic matter (humus) in profile (t ha^{-1})
HV EF	Harvest efficiency. Fraction of yield removed from field by harvest operation
IDC	Crop category number (integer) 1 Warm-season annual legume 2 Cold-season annual legume 3 Perennial legume 4 Warm-season annual 5 Cold-season annual 6 Perennial 7 Tree crop
IMN	N immobilized by decaying residue (kg ha^{-1})
IMP	P immobilized by decaying residue (kg ha^{-1})
IRGA	Irrigation water applied (mm)
LAI	Leaf area index ($\text{m}^2 \text{m}^{-2}$)
LAP(1,2)	Two points on optimal leaf area development curve. Numbers before decimal are % of growing season. Numbers after decimal are fractions of maximum potential leaf area index.
LIME	Limestone applied (CaCO_3 equivalent) (t ha^{-1})
MAT-HV	Tree crops only. Years from planting to maturity or harvest
MN P AC	Mineral P concentration in the active pool (g t^{-1})
MN P ST	Mineral P concentration in the stable pool (g t^{-1})
MNN	N mineralized (kg ha^{-1})
MNP	P mineralized (kg ha^{-1})
MUSL	Soil loss from water erosion using modified USLE (MUSLE) (t ha^{-1})
MXEF	Mixing efficiency of tillage operation--fraction of crop residue and other materials in each soil layer of the plot depth that is mixed uniformly within the plow depth
NFIX	N fixed by leguminous crops (kg ha^{-1})
NO3	Nitrate concentration (g t^{-1})
NS	N stress factor (0-1)
OP CD	Tillage equipment operation code: -2 Destroys furrow dikes -1 Builds furrow dikes 1 Harvests and kills crop 2 Harvests without killing 5 Plants in rows 6 Plants with drill
OR N AC	Organic N concentration in the active pool (g t^{-1})
OR N ST	Organic N concentration in the stable pool (g t^{-1})

ORG C	Organic C content (%)
ORG P	Organic P concentration (g t^{-1})
P5MX	Monthly maximum 0.5 h rainfall for period of record (mm)
PEP	Potential plant water evaporation (mm)
PET	Potential evaporation (mm)
PH	Soil pH in water
PHU	Potential heat units from planting to physiological maturity ($^{\circ}\text{C}$)
PLAB	Labile (plant-available) P in profile (kg ha^{-1})
PMIN	Mineral P present in the soil profile (kg ha^{-1})
PRK	Percolation below the root zone (mm)
PRKN	Mineral N loss in percolate (kg ha^{-1})
PRY	Price of yield ($\text{\$ t}^{-1}$)
PS	P stress factor (0-1)
PST	Pest damage factor (insects, weeds, disease)--fraction of yield remaining after damage
PW/D	Monthly probability of wet day after dry day
PW/W	Monthly probability of wet day after wet day
Q	Surface runoff (mm)
QIN	Inflow to the root zone from the water table (mm)
QP	Peak runoff rate (mm h^{-1})
RAD	Solar radiation (MJ m^{-2})
RAIN	Precipitation (mm)
RBMD	Biomass-energy ratio decline rate parameter
RD	Root depth (m)
RDMX	Maximum root depth (m)
REG	Crop growth regulator (minimum stress factor 0-1)
RHT	Ridge height after tillage operation (mm)
RHUM	Relative humidity
RIN	Ridge interval after tillage operation (m)
RLAD	Leaf-area-index decline rate parameter
RN	N in precipitation (kg ha^{-1})

ROCK	Soil coarse-fragment content (volume %)
RR	Random roughness of soil surface (mm)
RSD	Crop residue on soil surface (t ha^{-1})
RSDK	Residue decay (t ha^{-1})
RTRN	Total income from crop sales (\$)
RW	Total root weight (t ha^{-1})
RWT	Root weight in a soil layer (t ha^{-1})
SDW	Normal planting rate (kg ha^{-1})
SDRF	Monthly standard deviation of daily precipitation (mm)
SKCF	Monthly skew coefficient for daily precipitation
SM BS	Sum of bases in soil (cmol kg^{-1})
SNOW	Water content of snowfall (mm)
SSF	Lateral subsurface flow travel time (d)
SSFN	Mineral N loss in subsurface flow (kg ha^{-1})
STD	Standing dead crop residue (t ha^{-1})
STL	Standing live plant biomass (t ha^{-1})
STMN	Monthly average standard deviation of daily minimum air temperature ($^{\circ}\text{C}$)
STMX	Monthly average standard deviation of daily maximum air temperature ($^{\circ}\text{C}$)
STRS	The type and number of days of stress by month for the three highest stress variables. Water = 1, N = 2, P = 3, Temperature = 4, Aeration = 5.
	Example: 411107201 means that there were 11 days of temperature stress (is 411), 7 days of water stress (is 107), and 1 day of nitrogen stress (201).
SW	Total soil water in the profile (m m^{-1})
TAV	Average air temperature ($^{\circ}\text{C}$)
TB	Optimal temperature for plant growth ($^{\circ}\text{C}$)
TEMP	Temperature stress on crop growth (d)
TG	Minimum temperature for plant growth ($^{\circ}\text{C}$)
THK	Thickness of soil eroded by wind and water (mm)
TMN	Minimum daily air temperature ($^{\circ}\text{C}$)
TMP	Temperature in second soil layer ($^{\circ}\text{C}$)

TMX	Maximum daily air temperature (°C)
TNO3	Total NO ₃ present in the soil profile (kg ha ⁻¹)
TS	Temperature stress factor (0-1)
UNO3	N uptake by the crop (kg ha ⁻¹)
UPP	P uptake by the crop (kg ha ⁻¹)
USLE	Soil loss from water erosion using USLE (t ha ⁻¹)
WA	Energy to biomass conversion factor (t ha ⁻¹ MJ ⁻¹ m ⁻²)
WCY	Fraction water in yield
WENG	Wind energy (kWh m ⁻²)
WK	Soil erodibility factor for wind erosion
WP	Soil water content at wilting point (1500 kPa for many soils) (m m ⁻¹)
WS	Water stress factor (0-1)
WSYF	Coefficient of crop yield sensitivity to water stress at the most critical stage of growth
WTBL	Depth from soil surface to water table (m)
WVL	Wind velocity (m s ⁻¹)
YAP	Soluble P loss in runoff (kg ha ⁻¹)
YLD	Crop yield (t ha ⁻¹)
YLN	N in crop yield (kg ha ⁻¹)
YLP	P in crop yield (kg ha ⁻¹)
YNO3	NO ₃ loss in surface runoff (kg ha ⁻¹)
YON	Organic N loss with sediment (kg ha ⁻¹)
YP	P loss with sediment (kg ha ⁻¹)
YW	Soil loss from wind erosion (t ha ⁻¹)

APPENDIX X: EASE USER INSTRUCTIONS

Table X.1
EASE user instructions

EASE, was designed to perform nine data manipulation functions. These functions are provided to the user as optional modes of operation. By selecting the appropriate option number from the main menu screen the user can expedite data manipulation. The main menu screen is shown below.

The nine files contained in the EASE system are:

- EASEddy¹.EXE EASE main interactive program.
- EASEFILE.DAT EASE control data file listing other files.

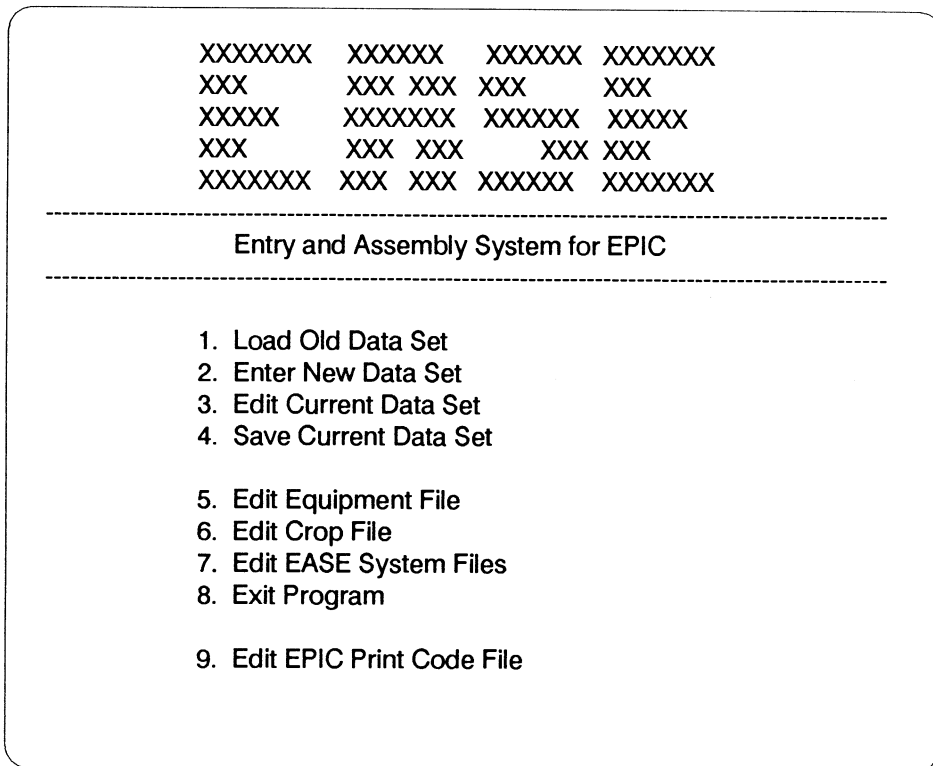

EASE System Requirements

EASE requires about 300K of main memory. It will work on a one- or two-drive system but works best on a hard drive. It is designed to work on almost any PC or compatible, or any computer system that supports interactive program input.

- PROMddy.DAT EASE prompt and range file.
- CROPddy.DAT EPIC crop parameters (EPIC DATA DISK).
- TILLddy.DAT EPIC tillage parameters (EPIC DATA DISK).
- MLRAWETH.DAT Monthly weather data listed by MLRA regions.
- WEATHER.DAT Monthly weather data listed by city and State.

¹ dddy is a version number for EASE or EPIC. Where: julianday is ddd, and y is the last digit of the year.
 EXAMPLE: 0858 refers to the 85th day of 1988.

WINDFILE.DAT Mean monthly wind speed and direction distributions for different locations.

SOIL1.DAT The soils data for soils 1-200 (table IV.2)

EASE requires that two statements be added to the system file, CONFIG.SYS, if they are not already there.

```
FILES = 20
DEVICE = ANSI.SYS
```

or if ANSI.SYS is in the DOS directory:

```
DEVICE = C:\DOS\ANSI.SYS
```

If the CONFIG.SYS file is not available, it must be created using the DOS manual. Simply use EDLIN or any text editor that will generate an ASCII file. Two subprograms provide access to the ANSI.SYS screen controls. Subprogram CLRSCN clears the screen and subprogram MOVETO moves the cursor to a particular line and column.

Installation Procedure

To install the EPIC/EASE package, copy the diskettes to the hard disk. Create a directory on the hard disk where the programs will be stored by entering the following command:

```
C> MD \EPIC <press return or enter>
```

where C> is the DOS prompt.

Then change the working directory to EPIC with:

```
C> CD \EPIC <ret>
```

Insert the EPIC diskette #1 into drive A: and copy all the files to the newly created directory called EPIC:

```
C> COPY A:.* C:\EPIC\.* <ret>
```

Then insert the EPIC diskette #2 into drive A: and repeat the above command. This installs all the files necessary to run EASE and EPIC.

Startup Procedure

To start EASE, enter the following:

```
C> EASE (or EASExxxx) <ret>
```

EASE reads a file called EASEFILE.DAT. This file contains all of the EASE system file names and is used to locate input data files. This file **MUST** be in the current working directory. All other files may be moved to other directories or diskettes if disk space is critical. The ability to transfer files also provides for replacing existing files or changing file names. EASEFILE.DAT is the axis of EASE and should always be checked first if problems occur. The EASE system files are set up to work with everything on a hard disk because most users work with a hard drive. However, it is possible to work from diskettes if a hard drive is not available. If a problem arises in loading the data files, such as a data file not found, EASE will edit these data file names so they may be corrected. EASE will try to read the files again when it returns to the main menu. If the names appear to be correct and the problem source cannot be determined, hold down the Ctrl key and press the Break key. This will allow a return to DOS to resolve the problem.

EASE reads the file names found in the file EASEFILE.DAT to locate all other data files:

```
EASEPROM.DAT (or PROMdddy.DAT)
EPICCROP.DAT (or CROPdddy.DAT)
EPICTILL.DAT (or TILLdddy.DAT)
```

EASEPROM.DAT contains the prompts for user communication and the typical ranges for each variable. The user may change these prompts and ranges with any text editor that

will edit an ASCII file. The main purpose of the ranges is to point out keypunch errors that produce absurd input values. The ranges represent reasonably low and high values of the variables rather than absolute limits. Thus, it is not uncommon for EASE to give an out of range warning. The user immediately inspects the input value and corrects existing errors. If there are no errors (the value is simply extreme), the user overrides the warning and continues.

Editor Commands

The edit commands SKIP, REENTER, CHANGE, UP, and DOWN allow the user to move freely through a data set and make necessary changes efficiently. The commands and the codes for activating them appear in the "command line" at the bottom of each edit screen. The EASE command line is:

-1 Skip, 0 Reenter, 1 to 8 to Change, 9 Up, 10 Down
?

The following discussion describes each EASE edit command.

-1 Skip Command

The data sets are built in sections as outlined in tables VII.1 and VIII.1. The skip command allows the user to move from one section to another while editing a data set. The skip mode is activated by entering a -1 in response to the command line. Once in the skip mode the user moves from section to section by inputting the section numbers from the following list:

- 0 MENU
- 1 TITLES
- 2 PROGRAM CONTROL CODES
- 3 GENERAL DATA
- 4 WATER EROSION DATA
- 5 MONTHLY WEATHER DATA
- 6 WIND EROSION DATA

- 7 SOIL DATA TABLE
- 8 MANAGEMENT INFORMATION
- 9 WEATHER FILENAMES (only for inputting daily weather)

The SKIP mode is most useful in editing. It is not recommended for use in entering new data sets.

0 (RE)ENTER Command

The REENTER command allows replacement of ALL inputs on a screen. REENTER is activated by entering 0 in response to the command line. Some data items may be out of range, causing EASE to prompt:

Value out of range. Use it anyway? (Y/N)

If the value is to be replaced, enter "N". Conversely, if the value is extreme but correct, enter "Y".

CHANGE Command

The change command is activated by entering the edit number of any data item in response to the command line. The edit number specifies section, page, and line location of the data item (table VIII.1). The numbers are separated by periods. For example 5.3.6 is the edit number for section 5, page 3, and line 6. Given the edit number, EASE prompts for a new value for that data item. CHANGE and REENTER perform similar functions except that only one edit line at a time can be replaced with CHANGE.

UP and DOWN Commands

The UP and DOWN commands are activated by entering the numbers specified in the command line. UP moves to the previous section and DOWN proceeds to the next section.

EASE Main Menu Options

Once EASE is loaded and all the data files are inputted the main menu will appear and the EASE session begins. At that time the user chooses the appropriate data manipulation function from the nine available options. The following discussion describes the functions of each of the nine options for manipulating data.

Option 1 Load Old Data Set - This option reads an existing EPIC data set from a file and stores it in EASE. It also converts old data sets to a form that is compatible with the latest version of EPIC. This conversion feature works for data sets created for EPIC2437 and later versions. The four numbers following EPIC give the date that the version was created. The first three numbers are the day of the year and the last number is the year. (2437 = day 243 of 1987)

Data sets from the earlier versions must be edited with a text editor, like EDLIN, or recreated using EASE.

Option 2 Enter New Data Set - This option is used to create new EPIC data sets. EPIC data sets are built in sections as described in tables VII.1 and VIII.1. When a section or part of a section is complete, the editing screen appears and allows modification of inputs on the screen. When all data on the screen are correct, the DOWN command is used to move the screen to the next input section. When all sections are complete, EASE returns automatically to the beginning of the data set to allow editing. The UP and SKIP commands are not recommended for use in building a new data set (option 2). It is usually better to enter the complete data set and then make corrections in the Edit mode (option 3).

Option 3 Edit Basic User-Supplied Data Set - This option is used to edit the basic user-supplied data set (tables VII.1 and VIII.1). The data set may have been entered using either option 1 or 2. An example EASE editing screen is shown below.

The section number on the screen refers to the data section and page number (tables VII.1 and VIII.1). The number before the decimal is

EASE - SECTION 2.1 Control Codes

1	Number Years of Simulation	20
2	Starting Date: Year	1901
3	Month	1
4	Day	39 [1, 31]
5	Printout Frequency Code	18
6	Printout Interval (Day, Months, or Years)	0
7	Weather Code	2
8	Number of Times Generator Cycles	0

-1 Skip, 0 (Re)Enter, 1 to 8 to Change, 9 Up, 10 Down
?

the section number and the number after the decimal is the page of that section. Each line on the screen is numbered, the numbers appearing in the first column. One or more data items may be required for each line. Typical ranges of the data items will appear when an input value is out of range. The example screen on the previous page illustrates an out-of-range input on line 4. The last line on the edit screen is the command line. The command options given on the edit screen are:

-1	SKIP
0	ReEnter
1-8	Change
9	Up
10	Down

Thus, the user chooses the proper command to edit the data set accurately and efficiently. Functions of the various commands are given in the Editor Commands section.

Option 4 Save Data Set - When editing is completed on a basic user-supplied data set, option 4 is used to save the data set. If the data set is new (option 2 development), a name is required. If an existing data set was inputted (option 1 development) and edited, it can be saved using its original name, or a new data set can be created by choosing a different name. The decision to replace or rename an existing data set is accomplished as follows:

Data set already exists. Replace? (Y/N)

To replace, the user enters "Y." To save under a different name, enter "N" and EASE prompts for the new name. To return to the main menu without saving a data set, enter "n" for Replace? and press return instead of entering the file name.

Option 5 Edit Equipment File - This option is used to edit the equipment file (table V.1) or add new equipment to the file. If there is only one user on a computer system, the equipment file can be edited freely without creating problems. However, if several users share the same equipment file, one user's edits may create tremendous problems for others. Once a number of data sets have been created, it is not

advisable to remove any types of equipment from the equipment file. This is true for single- or multiple-user systems because the equipment is specified in the basic data set by its order number in the equipment file. Obviously, removing equipment from the file changes order numbers for the remaining equipment. Conversely, any number of types of equipment may be added to the end of the equipment file without creating problems.

Option 6 Edit Crop File - This option is used to edit the crop parameter file (table III.1). Since the crop parameter file is shared by all users, editing can create the same problems described in option 5. As with option 5, deleting crops is not recommended, but crops can be added to the file freely.

Option 7 Edit EASE System Files - This option edits the file names in the EASE system file EASEFILE.DAT. This file contains all the file names needed by the EASE program. The user may change any of the file names or drive specifications (such as D:). If the drive specification is omitted, a default is assumed. A directory may also be used in the file name (such as \EASE) where the complete file name includes the beginning backslash: \EASE\EASEPROM.DAT. This option is called automatically if there is an error in reading any of the files listed in EASEFILE.DAT when EASE is initializing.

Option 8 Exit EASE Program- This option exits the program to the operating system provided a data set is not loaded. If a data set is present, EASE will prompt to SAVE THE CURRENT DATA SET?(Y/N). Answer "Y" to save the data as outlined in option 4. Once in the option 8 operating mode, the user may return to the EASE main menu by answering the prompt with "Y" and pressing return instead of entering a file name.

Option 9 Edit EPIC Print Code File - This option edits the output selection table (tables VII.2 and VIII.1, section 10) located in the file EPICPRNT.DAT or PRNTddd.DAT.

Automatic Inputting From Files

Most of the data necessary to build an EPIC data set are inputted automatically from files. Only sections 1-4 and 8 of the basic user-supplied data set (table VII.1) must be supplied from other sources. Wind data (speed and direction), weather data, and soil data may be inputted directly by the user (table VII.1, sections 5, 6, and 7) or automatically from files. These options are provided by the three EASE prompts:

- (1) Enter number for weather data or 0 to input/edit:
- (2) Enter number for wind data or 0 to input/edit:
- (3) Enter soil name or number or 0 to input/edit:

EASE reads wind, weather, and soil data from the files contained in the EPIC/EASE package or from other user-developed files. If a prompt is answered with 0, the user must input data manually for that particular section. Entering the number of the wind, weather, or soil causes EASE to retrieve the corresponding information from the file. Since the sections are independent, any combination of manual user input and file input is acceptable. To read data from user-developed files, the file names are inputted when EASE prompts. Otherwise, the user presses return and EASE uses the file names from EASEFILE.DAT.

Suggested Order for Data Set Creation	
1	Fill out data entry forms completely (table VIII.1).
2	Enter the new data set from the forms (option 2 main menu).
3	Return to the main menu (SKIP command).
4	Save the data set (option 4 main menu).
5	Edit the data set (option 1 main menu loads, and option 3 edits).
6	Run EPIC with the data set.

APPENDIX XI: EXAMPLE INPUT DATA

Table XI.1.
Data assembly forms for example data set

***** FORM 1 *****
EPIC DATA ASSEMBLY FORM

1.1 Title
 Bell, TX Houston Black Soil Series

 [EXAM1528]* Example EPIC Input Data

 867 mm 503 EI COTN GRSG WHET

2.1 Program control codes

2.1.1	Number of years of simulation	3
2.1.2	Starting date - Year	1
2.1.3	- Month	1
2.1.4	- Day	1
2.1.5	Output print code	1
2.1.6	Printout interval ¹	0
2.1.7	Weather code	0
2.1.8	Number of times generator cycles ¹	0

¹ May be left blank or zero if unknown.

* The first 8 characters of this line are used by EPIC in the EPICOUT file. An 8-character file name works well for this entry to reference printouts to their corresponding data sets.

***** FORM 2 *****
EPIC DATA ASSEMBLY FORM

3.1 General data

3.1.1	Drainage area	<u>1.</u>
3.1.2	Runoff curve number	<u>86.</u>
3.1.3	Channel length	<u>.10</u>
3.1.4	Average channel slope	<u>.025</u>
3.1.5	Manning's n--Channel roughness factor	<u>.05</u>
3.1.6	Manning's n--Surface roughness factor	<u>.05</u>
3.1.7	Peak runoff-rate rainfall-energy adjustment factor	<u>1.</u>
3.1.8	Latitude of watershed	<u>31.1</u>
3.1.9	Average elevation of watershed ²	<u>222.0</u>
3.1.10	Water content of snow on ground at start of simulation	<u>0.</u>
3.1.11	Average concentration of nitrogen in rainfall	<u>.8</u>
3.1.12	Number of years of cultivation before simulation starts	<u>50.</u>

4.1 Water erosion data

4.1.1	Slope length	<u>50</u>
4.1.2	Slope steepness	<u>.01</u>
4.1.3	Water erosion equation ¹	<u>2</u>
4.1.4	Erosion control practice	<u>1</u>

5.1 Weather data

	Enter weather access number (table I.2) to load from file and skip to section 6.1 OR enter zero and input below.	<u>0</u>
5.1.1	TP-40 10-year frequency 0.5-hour rainfall	<u>58.7</u>
5.1.2	TP-40 10-year frequency 6.0-hour rainfall	<u>122.5</u>
5.1.3	Number years of maximum monthly 0.5-hour rainfall record	<u>7.0</u>
5.1.4	Coefficient to estimate wet-dry probabilities given number of wet days ^{6,4}	<u>0</u>
5.1.5	Power used to modify exponential rainfall amount distribution ^{4,9}	<u>0</u>

¹ May be left blank or zero if unknown.

² Blank if Priestley-Taylor method is used to estimate potential evaporation.

⁴ May be left blank or zero if daily rainfall is inputted (ref. 2.1.7 > 0).

⁶ Blank or zero if rainfall is generated and wet-dry probabilities are available.

⁹ Blank if rainfall standard deviation and skew coefficient are available.

***** FORM 3 *****
EPIC DATA ASSEMBLY FORM

5.2.1 Average monthly maximum air temperature

14.8	16.8	21.4	25.6	29.2	33.7	35.7	36.0	32.6	27.2	20.5	15.6
------	------	------	------	------	------	------	------	------	------	------	------

5.2.2 Average monthly minimum air temperature

2.8	4.4	8.2	12.6	17.7	21.2	22.7	22.6	19.6	13.8	7.8	3.6
-----	-----	-----	------	------	------	------	------	------	------	-----	-----

5.2.3 Monthly standard deviation maximum air temperature^{3,8}

7.76	6.79	5.99	4.27	3.41	2.97	2.73	2.89	3.85	4.68	5.96	6.04
------	------	------	------	------	------	------	------	------	------	------	------

5.2.4 Monthly standard deviation minimum air temperature^{3,8}

6.51	5.52	5.56	4.62	3.44	2.61	1.89	2.04	3.40	4.68	5.58	5.40
------	------	------	------	------	------	------	------	------	------	------	------

5.2.5 Average monthly precipitation

55.	59.	61.	104.	114.	77.	50.	52.	72.	73.	72.	74.
-----	-----	-----	------	------	-----	-----	-----	-----	-----	-----	-----

5.2.6 Monthly standard deviation of daily precipitation^{4,1}

9.8	9.4	9.7	16.8	21.8	14.0	12.4	14.5	16.5	17.0	14.2	10.7
-----	-----	-----	------	------	------	------	------	------	------	------	------

5.2.7 Monthly skew coefficient for daily precipitation^{4,1}

2.36	2.25	2.01	2.01	2.19	2.26	2.10	2.79	3.77	1.97	1.86	2.25
------	------	------	------	------	------	------	------	------	------	------	------

5.3.1 Monthly probability of wet day after dry day^{4,5}

.140	.210	.166	.203	.188	.138	.072	.111	.138	.123	.142	.133
------	------	------	------	------	------	------	------	------	------	------	------

5.3.2 Monthly probability of wet day after wet day^{4,5}

.397	.424	.417	.414	.429	.416	.344	.389	.455	.337	.425	.414
------	------	------	------	------	------	------	------	------	------	------	------

5.3.3 Average number of days of rain per month⁶

6.11	7.75	6.87	7.72	7.68	5.73	3.07	4.77	6.06	4.85	5.94	5.73
------	------	------	------	------	------	------	------	------	------	------	------

5.3.4 Monthly maximum 0.5 hour-rainfall for period of record (TP24)

10.7	17.0	17.5	23.9	40.1	22.	50.8	29.2	31.7	36.8	8.9	12.2
------	------	------	------	------	-----	------	------	------	------	-----	------

5.3.5 Monthly average daily solar radiation

269.	317.	410.	496.	.464	606.	601.	538.	442.	359.	282.	253.
------	------	------	------	------	------	------	------	------	------	------	------

5.3.6 Monthly average relative humidity²

.70	.69	.62	.65	.69	.67	.61	.60	.62	.65	.64	.67
-----	-----	-----	-----	-----	-----	-----	-----	-----	-----	-----	-----

¹ May be left blank or zero if unknown.
² Blank if Priestley-Taylor method is used to estimate potential evaporation.
³ Temperature extremes may be substituted.
⁴ May be left blank or zero if daily rainfall is inputted (ref. 2.1.7 > 0).
⁵ Blank or zero if unknown and average number of days of rain per month is available.
⁶ Blank or zero if rainfall is generated and wet-dry probabilities are available.
⁸ Blank or zero if daily temperature is inputted (ref. 2.1.7 > 1).

***** FORM 4 *****
EPIC DATA ASSEMBLY FORM

6.1 Wind erosion data

Enter wind access number (table I.4) to load from file and skip to section 7.1 or enter zero and input below. 0

6.1.1 Field length⁷

6.1.2 Field width⁷

6.1.3 Clockwise angle of field from north⁷

6.1.4 Standing dead crop residue¹

6.2 Wind data

6.2.1 Power of modified exponential distribution of wind speed^{2&7} .50

6.2.2 Climatic factor⁷

6.2.3 Wind erosion adjustment factor⁷

6.3.1 Average monthly wind velocity^{2&7}
5.81 5.87 6.68 6.68 5.81 5.79 4.92 4.90 4.47 4.45 4.92 5.36

6.3.2 N wind during each month⁷

6.3.3 NNE wind during each month⁷

6.3.4 NE wind during each month⁷

6.3.5 ENE wind during each month⁷

6.3.6 E wind during each month⁷

6.3.7 ESE wind during each month⁷

6.3.8 SE wind during each month⁷

6.3.9 SSE wind during each month⁷

¹ May be left blank or zero if unknown.
² Blank if Priestley-Taylor method is used to estimate potential evaporation.
⁷ Blank or zero if wind erosion is not estimated.

***** FORM 6 *****
EPIC DATA ASSEMBLY FORM

7.1 Soil data

Enter soil access number or name to load from file and skip to section 10.1 or enter zero and input below. 0

- 7.1.1 Soil albedo .10
- 7.1.2 Maximum number of soil layers¹
- 7.1.3 Minimum thickness of maximum layer¹
- 7.1.4 Minimum soil profile thickness¹
- 7.1.5 Initial soil water content-fraction of field capacity¹
- 7.1.6 Minimum depth to water table¹
- 7.1.7 Maximum depth to water table¹
- 7.1.8 Initial depth to water table¹
- 7.1.9 Soil weather code¹

7.2.1 Depth from the surface to the bottom of the soil layer

0.01 0.18 0.48 0.71 0.91 1.12 1.35 1.51 2.00 0.00

7.2.2 Bulk density of the soil layer

1.25 1.25 1.20 1.25 1.30 1.26 1.30 1.36 1.32

7.2.3 Wilting point¹

7.2.4 Field capacity¹

7.2.5 Sand content

7.2 7.3 5.4 4.9 3.8 6.0 6.4 5.7 6.6

7.2.6 Silt content

35.7 35.7 39.3 37.1 36.8 35.1 38.2 40.2 41.9

7.2.7 Organic N concentration¹

1190. 1190. 960. 760. 580. 390. 353. 158. 93.

7.2.8 Soil pH

8.0 8.0 8.3 8.2 8.0 8.0 8.1 8.3 8.2

¹ May be left blank or zero if unknown.

***** FORM 7 *****
EPIC DATA ASSEMBLY FORM

7.3.1	Sum of bases ¹									
7.3.2	Organic carbon	1.5	1.5	1.28	1.09	.840	.870	.470	.380	.284
7.3.3	Calcium carbonate	28.0	28.0	30.0	30.0	29.0	29.0	35.0	35.0	40.0
7.3.4	Cation exchange capacity ¹									
7.3.5	Coarse fragment content ¹									
7.3.6	Nitrate concentration ¹	5.	5.	5.	5.	5.	5.	5.	5.	5.
7.3.7	Labile P concentration ¹	25.	25.	20.	15.	15.	10.	10.	10.	5.
7.3.8	Crop residue ¹	.013	.013	.010	.006	.006	.006	.003	.003	.001
7.4.1	Bulk density (oven dry) ¹	1.50	1.50	1.45	.150	1.55	1.50	1.55	1.61	1.59
7.4.2	Phosphorus sorption ratio ¹									
7.4.3	Saturated conductivity ¹									
7.4.4	Subsurface flow travel time ¹									
7.4.5	Organic P concentration ¹									

¹ May be left blank or zero if unknown.

***** FORM 8 *****
EPIC DATA ASSEMBLY FORM

8.1 Management information - operation codes

8.1.1	Crop rotation duration	3
8.1.2	Irrigation code ¹	0
8.1.3	Minimum application interval for automatic irrigation ¹	0
8.1.4	Minimum fertilizer application interval for automatic fertilizer ¹	30
8.1.5	Liming code ¹	0
8.1.6	Furrow dike code ¹	0
8.1.7	Drainage code ¹	0

8.2 Management information - operation variables

8.2.1	Water stress factor to trigger automatic irrigation	0.00
8.2.2	Irrigation runoff ratio	0.00
8.2.3	Maximum annual irrigation volume allowed for each crop ¹	0.00
8.2.4	Minimum single application volume automatic irrigation ¹	0.00
8.2.5	Maximum single application volume automatic irrigation ¹	0.00
8.2.6	N stress factor to trigger automatic fertilizer	0.80
8.2.7	Fraction of maximum N fertilizer applied at planting ¹	0.01
8.2.8	Maximum annual N fertilizer application for a crop ¹	500.
8.2.9	Time required for drainage system to reduce stress	1.00
8.2.10	Fraction of furrow dike volume available for storage	.80

¹ May be left blank or zero if unknown.

***** FORM 10 *****
EPIC DATA ASSEMBLY FORM

8.1 Management information - Tillage schedule
 (one for each year of rotation)

	Month	Day	Tillage number	Crop number*	Tree code ^{1**}	Heat units ^{1*}
1	4	1	19			
2	4	1	75			
3	4	15	2	10	0	0.00
4	5	15	19			
5	6	15	19			
6	9	1	50			
7	9	25	57			
8	10	1	15			
9	12	1	15			
10						
11						
12						
13						
14						
15						
16						
17						
18						
19						
20						

¹ May be left blank or zero if unknown.
 * Only inputted when planting (heat units are optional), zero otherwise.
 ** Only inputted when growing trees (and then optional), zero otherwise.

***** FORM 10 *****
EPIC DATA ASSEMBLY FORM

8.1 Management information - Tillage schedule
 (one for each year of rotation)

	Month	Day	Tillage number	Crop number*	Tree code ^{1**}	Heat units ^{1*}
1	3	1	19			
2	3	20	2	3	0	0.00
3	5	10	19			
4	8	1	50			
5	8	20	57			
6	9	5	33			
7	9	20	19			
8	9	21	29			
9	10	1	3	4	0	0.00
10						
11						
12						
13						
14						
15						
16						
17						
18						
19						
20						

¹ May be left blank or zero if unknown.
^{*} Only inputted when planting (heat units are optional), zero otherwise.
^{**} Only inputted when growing trees (and then optional), zero otherwise.

***** FORM 10 *****
EPIC DATA ASSEMBLY FORM

8.1 Management information - Tillage schedule
 (one for each year of rotation)

	Month	Day	Tillage number	Crop number*	Tree code ^{1**}	Heat units ^{1*}
1	6	1	50			
2	6	15	28			
3	10	15	29			
4	11	1	15			
5						
6						
7						
8						
9						
10						
11						
12						
13						
14						
15						
16						
17						
18						
19						
20						

¹ May be left blank or zero if unknown.
^{*} Only inputted when planting (heat units are optional), zero otherwise.
^{**} Only inputted when growing trees (and then optional), zero otherwise.

Table XI.2.

EASE-generated example data set

1	BELL, TX HOUSTON BLACK SOIL SERIES											
2	EXAM1528 EXAMPLE EPIC INPUT DATA											
3	876	MM	503	EI	COTN	GRSG	WHET					
4	3	1	1	1	6	0	0					
5	1.000	86.000	.100	.0250	.050	.050	1.000	31.100	222.000	.000		
6	.800	50.000										
7	50.000	2.0100	1.000									
8	58.70	122.50	7.00	.00	.00							
9	14.80	16.80	21.40	25.60	29.20	33.70	35.70	36.00	32.60	27.20	20.50	15.60
10	2.80	4.40	8.20	12.60	17.70	21.20	22.70	22.60	19.60	13.80	7.80	3.60
11	7.76	6.79	5.99	4.27	3.41	2.97	2.73	2.89	3.85	4.68	5.96	6.04
12	6.51	5.52	5.56	4.62	3.44	2.61	1.89	2.04	3.40	4.68	5.58	5.40
13	55.0	59.0	61.0	104.0	114.0	77.0	50.0	52.0	72.0	73.0	72.0	74.0
14	9.9	9.4	9.7	16.8	21.8	15.0	12.4	14.5	16.5	17.0	14.2	10.7
15	2.36	2.25	2.01	2.01	2.19	2.26	2.10	2.79	3.77	1.97	1.86	2.25
16	.148	.210	.166	.203	.188	.138	.072	.110	.138	.123	.142	.133
17	.397	.424	.417	.414	.429	.416	.344	.389	.455	.337	.425	.414
18	6.11	7.75	6.87	7.72	7.68	5.73	3.07	4.77	6.06	4.85	5.94	5.73
19	10.7	17.0	17.5	23.9	40.1	22.9	50.8	29.2	31.7	36.8	8.9	12.2
20	269.	317.	410.	496.	46.	606.	601.	538.	442.	359.	282.	253.
21	.70	.69	.62	.65	.69	.67	.61	.60	.62	.65	.64	.67
22	.000	.000	.000	.000	.000							
23	.50	.00	.00	.00								
24	5.81	5.87	6.68	6.68	5.81	5.79	4.92	4.90	4.47	4.45	4.92	5.36
25	0.	0.	0.	0.	0.	0.	0.	0.	0.	0.	0.	0.
26	0.	0.	0.	0.	0.	0.	0.	0.	0.	0.	0.	0.
27	0.	0.	0.	0.	0.	0.	0.	0.	0.	0.	0.	0.
28	0.	0.	0.	0.	0.	0.	0.	0.	0.	0.	0.	0.
29	0.	0.	0.	0.	0.	0.	0.	0.	0.	0.	0.	0.
30	0.	0.	0.	0.	0.	0.	0.	0.	0.	0.	0.	0.
31	0.	0.	0.	0.	0.	0.	0.	0.	0.	0.	0.	0.
32	0.	0.	0.	0.	0.	0.	0.	0.	0.	0.	0.	0.
33	0.	0.	0.	0.	0.	0.	0.	0.	0.	0.	0.	0.
34	0.	0.	0.	0.	0.	0.	0.	0.	0.	0.	0.	0.
35	0.	0.	0.	0.	0.	0.	0.	0.	0.	0.	0.	0.
36	0.	0.	0.	0.	0.	0.	0.	0.	0.	0.	0.	0.
37	0.	0.	0.	0.	0.	0.	0.	0.	0.	0.	0.	0.
38	0.	0.	0.	0.	0.	0.	0.	0.	0.	0.	0.	0.
39	0.	0.	0.	0.	0.	0.	0.	0.	0.	0.	0.	0.
40	0.	0.	0.	0.	0.	0.	0.	0.	0.	0.	0.	0.
41	.10	.00	.00	.00	.00	.00	.00	.00	.00	.00	.00	.00
42	.010	.180	.480	.710	.910	1.120	1.350	1.510	1.510	2.000	.000	.000
43	1.250	1.250	1.200	1.250	1.300	1.260	1.300	1.360	1.320	1.320	.000	.000
44	.000	.000	.000	.000	.000	.000	.000	.000	.000	.000	.000	.000
45	.000	.000	.000	.000	.000	.000	.000	.000	.000	.000	.000	.000
46	7.3	7.3	5.4	4.9	3.8	6.0	6.4	5.7	6.6	6.6	.0	.0
47	35.7	35.7	3.9	37.1	36.8	35.1	38.2	40.2	41.9	41.9	.0	.0
48	1190.	1190.	960.	760.	580.	390.	253.	158.	93.	93.	.0	.0
49	8.0	8.0	8.3	8.2	8.0	8.0	8.1	8.3	8.2	8.2	.0	.0
50	.0	.0	.0	.0	.0	.0	.0	.0	.0	.0	.0	.0
51	1.500	1.500	1.280	1.090	.840	.870	.470	.380	.284	.284	.000	.000
52	28.0	28.0	30.0	30.0	29.0	29.0	35.0	35.0	40.0	40.0	.0	.0
53	.0	.0	.0	.0	.0	.0	.0	.0	.0	.0	.0	.0
54	.0	.0	.0	.0	.0	.0	.0	.0	.0	.0	.0	.0
55	5.	5.	5.	5.	5.	5.	5.	5.	5.	5.	0.	0.
56	25.	25.	20.	15.	15.	10.	10.	10.	5.	5.	0.	0.
57	.013	.013	.010	.006	.006	.006	.003	.003	.001	.001	.000	.000
58	1.500	1.500	1.450	1.500	1.550	1.500	1.550	1.610	1.590	1.590	.000	.000
59	.000	.000	.000	.000	.000	.000	.000	.000	.000	.000	.000	.000
60	.000	.000	.000	.000	.000	.000	.000	.000	.000	.000	.000	.000
61	0.	0.	0.	0.	0.	0.	0.	0.	0.	0.	0.	0.
62	0.	0.	0.	0.	0.	0.	0.	0.	0.	0.	0.	0.

Table XI.2.--Continued.
EASE-generated example data set

63	3	0	0	30	0	0	0						
64	.000		.000		.000	.000	.000	.000	.800	.010	500.000	1.000	.800
65	4	1	19										
66	4	1	75										
67	4	15	2	10	0	.00							
68	5	15	19										
69	6	15	19										
70	9	1	50										
71	9	25	57										
72	10	1	15										
73	12	1	15										
74													
75	3	1	19										
76	3	20	2	3	0	.00							
77	5	10	19										
78	8	1	50										
79	8	20	57										
80	9	5	33										
81	9	20	19										
82	9	21	29										
83	10	1	3	4	0	.00							
84													
85	6	1	50										
86	6	15	28										
87	10	15	29										
88	11	1	15										
89													

APPENDIX XII: EXAMPLE OUTPUT

Table XII.1.
 EPIC output from example input data using annual printout

8/22/88 13: 7:48

EPIC PC 1758 VERSION
 BELL TX HOUSTON BLACK SOIL SERIES
 EXAM1528 EXAMPLE EPIC INPUT DATA
 876 MM 503 E1 COTN GRSG WHET

GENERAL INFORMATION

-----VARIABLE NAMES
 TMX TMN RAD RAIN SNOW Q SSF PRK ET EP SW WTBL
 MNW IMN DN NFIX UNO3 HMN TNO3 YP YAP UPP MNP IMP
 IRGA PET RHUM HUM RSDK EVN AOF USLE PLAB STL WVL FALF
 NS PS TS AS REG TAV ALPH WENG DAYQ QIN STMK STMN
 RTRN
 EI MUSL C YW YON YNO3 SSFN PRKN
 HU LAI RD RW BIOM RSD STD TMP
 PEP FN CN QP LIME HRLT WS
 RN DAYP STRS YLD YLN YLP PMIN COST
 YW YON YNO3 SSFN PRKN
 RW BIOM RSD STD TMP
 CN QP LIME HRLT WS
 YLD YLN YLP PMIN COST

-----GENERATOR SEEDS AFTER 0 CYCLES
 748932582 1 1985072130 2 1631331038 3 67377721 4 366304404 5 1767585417 6 1980520317 8

MISCELLANEOUS PARAMETERS

PARM	SCRPT1	SCRPT2	SCRPT1C	SCRPT2C
1	1.000	50.050	.88776E+01	.13253E+02
2	1.500	5.500	-.29244E+01	-.14264E+01
3	10.000	50.100	.65038E+01	.99995E+01
4	.000	50.587	-.35088E+00	-.13862E+01
5	.200	10.050	.30370E+01	-.23931E+02
6	.000	5.100	-.68557E+00	-.22588E+01
7	.000	5.750	-.12910E+01	-.56067E+02
8	10.000	50.000	.50000E+02	.10000E+03
9	.100	.000	.00000E+00	.00000E+00
10	10.000	.000	.00000E+00	.00000E+00
11	.010	.000	.00000E+00	.00000E+00
12	10.000	.000	.00000E+00	.00000E+00
13	10.000	.000	.00000E+00	.00000E+00
14	1.000	.000	.00000E+00	.00000E+00

Table XII.1.--Continued
 EPIC output from example input data using annual printout

8/22/88 13: 7:48

EPIC PC 1758 VERSION

BELL TX HOUSTON BLACK SOIL SERIES
 EXAM1528 EXAMPLE EPIC INPUT DATA
 876 MM 503 EI COIN GRSG WHET

GENERAL INFORMATION

SIMULATION DURATION = 3 Y
 BEGINNING DATE = 1- 1- 1
 DRAINAGE AREA = 1.0 HA
 LATITUDE = 31.10 DEG
 ELEVATION = 222.0 M
 CHANNEL
 LENGTH = .10 KM SLOPE = .0250 M/M MANNINGS N = .050
 LAND SLOPE
 LENGTH = 50.0 M STEEPNESS = .0100 M/M MANNINGS N = .050
 WATER EROSION FACTORS--DRIVING EQ = USLE
 LS = .140 P = 1.000
 TIME OF FLOW CONCENTRATION = .43 H
 RUNOFF CN2 = 86.0
 SLOPE ADJ CN2 = 83.9
 PEAK RATE-EI ADJ FACTOR = 1.000
 INITIAL WATER CONTENT OF SNOW = .0 MM
 CULTIVATION PERIOD BEFORE SIMULATION = 50.0 Y
 AVE N CONC IN RAINFALL = .80 G/T
 COSTS
 N FERT = .51 \$/KG
 P FERT = .57 \$/KG
 LIME = 31.00 \$/T
 IRR WATER = .04 \$/MM
 PESTICIDE = 10.00 \$/HA

Table XII.1.--Continued
 EPIC output from example input data using annual printout

8/22/88 13: 7:48

EPIC PC 1758 VERSION

BELL TX HOUSTON BLACK SOIL SERIES
 EXAM1528 EXAMPLE EPIC INPUT DATA
 876 MM 503 E1 COTN GRSG WHET

WEATHER DATA

TP-40 10 YR FREQ RAINFALL 0.5 H DUR = 59. MM 6.0 H DUR = 123. MM

PERIOD OF RECORD FOR P5MX = 7. Y

*****RAIN, TEMP, RAD, WIND SPEED, & REL HUM ARE GENERATED*****

RAINFALL DIST IS SKEWED NORMAL

*****PENMAN EQ USED TO EST POT ET*****

VERNILIZATION TIME = 76. D

-----AVE MO VALUES

	JAN	FEB	MAR	APR	MAY	JUN	JUL	AUG	SEP	OCT	NOV	DEC	YR	TMX
TMX	14.80	16.80	21.40	25.60	29.20	33.70	35.70	36.00	32.60	27.20	20.50	15.60	25.76	TMX
TMN	2.80	4.40	8.20	12.60	17.70	21.20	22.70	22.60	19.60	13.80	7.80	3.60	13.08	TMN
STMX	7.76	6.79	5.99	4.27	3.41	2.97	2.73	2.89	3.85	4.68	5.96	6.04		STMX
STMN	6.51	5.52	5.56	4.62	3.44	2.61	1.89	2.04	3.40	4.68	5.58	5.40		STMN
RAIN	55.0	59.0	61.0	104.0	114.0	77.0	50.0	52.0	72.0	73.0	72.0	74.0	863.0	RAIN
SDRF	9.9	9.4	9.7	16.8	21.8	15.0	12.4	14.5	16.5	17.0	14.2	10.7		SDRF
SKCF	2.36	2.25	2.01	2.03	2.19	2.26	2.10	2.79	3.77	1.97	1.86	2.25		SKCF
PW/D	.148	.210	.166	.203	.188	.138	.072	.110	.138	.123	.142	.133		PW/D
PW/W	.397	.424	.417	.414	.429	.416	.344	.389	.455	.337	.425	.414		PW/W
DAYP	6.11	7.75	6.87	7.72	7.68	5.75	3.07	4.73	6.06	4.85	5.94	5.73	72.24	DAYP
P5MX	10.7	17.0	17.5	23.9	40.1	22.9	50.8	29.2	31.7	36.8	8.9	12.2		P5MX
RAD	11.	13.	17.	21.	2.	25.	25.	23.	18.	15.	12.	11.	16.	RAD
RAD	15.	18.	23.	28.	31.	33.	33.	31.	28.	24.	19.	16.	16.	RAD
HRLT	10.12	10.64	11.47	12.48	13.39	14.05	14.14	13.63	12.74	11.76	10.82	10.20		HRLT
RHUM	.70	.69	.62	.65	.69	.67	.61	.60	.62	.65	.64	.67		RHUM
ALPH	.28	.34	.35	.35	.34	.47	.43	.55	.46	.33	.30	.17		ALPH
WVL	5.81	5.87	6.68	6.68	5.81	5.79	4.92	4.90	4.47	4.45	4.92	5.36	5.47	WVL
WENG	511.	445.	704.	721.	267.	420.	128.	157.	4.0	68.	164.	304.	3889.	WENG

-----WIND EROSION DATA

CF = 23
 FIELD LENGTH = .00 KM
 FIELD WIDTH = .00 KM
 FIELD ANGLE = 0. DEG
 WIND SPEED MOD EXP POWER PARM = .50
 ACCELERATED WIND EROSION FACTOR = .000

BELL TX HOUSTON BLACK SOIL SERIES
 EXAM1528 EXAMPLE EPIC INPUT DATA
 876 MM 503 EI COTN GRSG WHET

SOIL DATA

SOIL ALBEDO = .10
 MAX NUMBER SOIL LAYERS = 10.
 MIN THICKNESS FOR LAYER SPLITTING = .10 M
 MIN PROFILE THICKNESS--STOPS SIMULATION = .10 M
 MIN WATER TABLE DEPTH = 50.00 M
 MAX WATER TABLE DEPTH = 100.00 M
 INITIAL WATER TABLE DEPTH = 75.00 M
 SOIL WEATHERING CODE = 0.

	SOIL LAYER NO										TOT
	1	2	3	4	5	6	7	8	9		
DEPTH(M)	1.00	2.10	3.48	4.71	5.91	6.12	7.35	8.51	9.2.00		
POROSITY(M/M)	.528	.528	.547	.528	.509	.525	.509	.487	.502		.517
FC SW(M/M)	.447E	.447E	.492E	.444E	.447E	.443E	.433E	.419E	.404		.437
WP SW(M/M)	.327E	.327E	.410E	.323E	.335E	.325E	.304E	.305E	.281		.324
SW(M/M)	.374E	.374E	.443E	.370E	.378E	.371E	.351E	.350E	.329E		.368
SAT COND(MM/H)	1.31E	1.31E	.99E	1.26E	1.13E	1.23E	1.30E	1.12E	1.46		
SSF TIME(D)	967.E	967.E	1028.E	987.E	1083.E	1001.E	1006.E	1194.E	959		
BD 33KPA(T/M3)	1.25	1.25	1.20	1.25	1.30	1.26	1.30	1.36	1.32		
BDD OV DRY(T/M3)	1.50	1.50	1.45	1.50	1.55	1.50	1.55	1.61	1.59		
SAND(%)	7.3	7.3	5.4	4.9	3.8	6.0	6.4	5.7	6.6		
SILT(%)	35.7	35.7	3.9	37.1	36.8	35.1	38.2	40.2	41.9		
CLAY(%)	57.0	57.0	90.7	58.0	59.4	58.9	55.4	54.1	51.5		
ROCK(%)	.0	.0	.0	.0	.0	.0	.0	.0	.0		
PH	8.0	8.0	8.3	8.2	8.0	8.0	8.1	8.3	8.2		
SM BSC(MOL/KG)	8.0E	8.0E	8.3E	8.2E	8.0E	8.0E	8.1E	8.3E	8.2		
CEC(CMOL/KG)	8.0E	8.0E	8.3E	8.2E	8.0E	8.0E	8.1E	8.3E	8.2		
AL SAT(%)	.0E	.0E	.0E	.0E	.0E	.0E	.0E	.0E	.0		
CAC03(%)	28.0	28.0	30.0	30.0	29.0	29.0	35.0	35.0	40.0		321.
LAB P(G/T)	25.	25.	20.	15.	15.	10.	10.	10.	5.		
P SORP RTO	.41E	.41E	.40E	.40E	.40E	.40E	.37E	.37E	.34		
MN P AC(G/T)	36.E	36.E	30.E	23.E	22.E	15.E	17.E	17.E	10.		506.
MN P ST(G/T)	144.E	144.E	122.E	91.E	89.E	59.E	69.E	69.E	40.		2025.
ORG P(G/T)	149.E	149.E	120.E	95.E	73.E	49.E	32.E	20.E	12.		1570.
NO3(G/T)	5.	5.	5.	5.	5.	5.	5.	5.	5.		128.
ORG N AC(G/T)	238.	238.	77.	61.	46.	31.	20.	13.	7.		1327.
ORG N ST(G/T)	952.	952.	883.	699.	534.	359.	233.	145.	86.		11233.
ORG C(%)	1.50	1.50	1.28	1.09	.84	.87	.67	.38	.28		
CROP_RSD(T/HA)	.01	.00	.00	.00	.00	.00	.00	.00	.00		.06
RWT(T/HA)	.00	.00	.00	.00	.00	.00	.00	.00	.00		.00

Table XII.1.--Continued
 EPIC output from example input data using annual printout

8/22/88 13: 7:48

EPIC PC 1758 VERSION
 BELL TX HOUSTON BLACK SOIL SERIES
 EXAM1528 EXAMPLE EPIC INPUT DATA
 876 MM 503 EI COTN GRSSG WHET

MANAGEMENT DATA

DRYLAND AGRICULTURE
 AUTO FERT
 N STRSS TRIGGER = .80
 MIN APPL INTERVAL = 30 D
 MAX N FERT/CROP = 500. KG/HA
 FRACTION OF MAX N FERT POTENTIALLY APPLIED AT PLANTING = .00
 LIME APPLIED AS NEEDED

-----OPERATION SCHEDULE FOR 3 YR ROTATION

YR 1		YR 2		YR 3	
MO	DA	MO	DA	MO	DA
4	1	3	1	6	1
4	1	3	20	6	15
4	15	5	10	10	15
5	15	8	1	10	15
6	15	8	20	10	29
9	1	9	5	11	1
9	25	9	21		
10	1	10	1		
12	1				

MO	DA	IDNO	NAME	COST(\$)	MX EF	RR(MM)	DP(MM)	RHT(MM)	RIN(M)	DKH(MM)	DKI(M)	OP	CD	HV EF	CROP	MAT-HV(Y)
4	1	19	ROW CULT	13.52	.30	15	25	100	1.00	0	.00	0	0	.000		0
4	1	75	BDYKE100	15.00	-.70	10	40	100	1.00	100	10.00	0	0	.000		0
4	15	2	ROW PLT	20.00	-.05	5	60	10	.86	0	.00	5	5	.000	COTS	0
5	15	19	ROW CULT	13.52	.30	15	25	100	1.00	0	.00	0	0	.000		0
6	15	19	ROW CULT	13.52	.30	15	25	100	1.00	0	.00	0	0	.000		0
9	1	50	HARV1.95	25.00	.00	0	0	0	.00	0	.00	1	1	.950		0
9	25	57	SHREDDER	21.87	-.00	0	-.75	0	.00	0	.00	0	0	.000		0
10	1	15	LISTER	9.14	-.80	25	100	150	1.00	0	.00	0	0	.000		0
12	1	15	LISTER	9.14	.80	25	100	150	1.00	0	.00	0	0	.000		0

MO	DA	IDNO	NAME	COST(\$)	MX EF	RR(MM)	DP(MM)	RHT(MM)	RIN(M)	DKH(MM)	DKI(M)	OP	CD	HV EF	CROP	MAT-HV(Y)
3	1	19	ROW CULT	13.52	.30	15	25	100	1.00	0	.00	0	0	.000		0
3	20	2	ROW PLT	20.00	.05	5	60	10	.86	0	.00	5	5	.000	GRSG	0
5	10	19	ROW CULT	13.52	.30	15	25	100	1.00	0	.00	0	0	.000		0
5	10	19	ROW CULT	13.52	.30	15	25	100	1.00	0	.00	1	1	.950		0
8	1	50	HARV1.95	25.00	.00	0	0	0	.00	0	.00	0	0	.000		0
8	20	57	SHREDDER	21.87	-.00	0	-.75	0	.00	0	.00	0	0	.000		0
9	5	33	OFFSET-D	19.87	.75	50	100	0	1.00	0	.00	0	0	.000		0
9	20	19	ROW CULT	13.52	.30	15	25	100	1.00	0	.00	0	0	.000		0
9	21	29	TAN DISK	13.44	.50	18	75	0	1.00	0	.00	0	0	.000		0
10	1	3	PLANT DR	17.54	.25	10	40	25	.17	0	.00	6	6	.000	WMHT	0

MO	DA	IDNO	NAME	COST(\$)	MX EF	RR(MM)	DP(MM)	RHT(MM)	RIN(M)	DKH(MM)	DKI(M)	OP	CD	HV EF	CROP	MAT-HV(Y)
6	1	50	HARV1.95	25.00	.00	0	0	0	.00	0	.00	1	1	.950		0
6	15	28	MB PLOW	27.18	-.90	30	150	0	.00	0	.00	0	0	.000		0
10	15	29	TAN DISK	13.44	.50	18	75	0	.00	0	.00	0	0	.000		0
11	1	15	LISTER	9.14	.80	25	100	150	1.00	0	.00	0	0	.000		0

Table XII.1.--Continued
 EPIC output from example input data using annual printout

8/22/88 13: 7:48

EPIC PC 1758 VERSION
 BELL TX HOUSTON BLACK SOIL SERIES
 EXAM1528 EXAMPLE EPIC INPUT DATA
 876 MM 503 EI COTN GRSG WHET

		CROP PARAMETERS	
WA	COTS	GRSG	WJHT
HI	17.5	35.0	35.0
TB	27.5	5.0	15.42
TG	12.0	10.0	15.0
DMLA	5.0	5.0	8.0
DLAI	.85	.80	.80
LAP1	15.010	15.050	15.010
LAP2	50.950	50.950	50.950
FRS1	5.010	5.010	5.010
FRS2	15.050	15.050	15.100
RLAD	2.00	2.00	1.00
RBMD	2.00	2.00	10.00
ALT	3.0	2.0	2.0
CAF	.85	.85	.85
SDW	30.0	5.0	90.0
HMX	1.00	1.50	1.20
RDMX	2.00	2.00	2.00
CVM	.200	.200	.050
CNY	.0330	.0200	.0234
CPY	.0046	.0028	.0033
WSYF	.0100	.0100	.0100
PST	.95	.95	.95
COSD	.88	1.54	.18
PRY	1100.00	96.00	120.00
WCY	.00	.14	.12
BN1	.0580	.0440	.0600
BN2	.0192	.0164	.0251
BN3	.0177	.0128	.0134
BP1	.0081	.0060	.0084
BP2	.0027	.0022	.0032
BP3	.0025	.0018	.0019
BW1	1.158	.657	3.390
BW2	.603	.657	3.390
BW3	.332	.320	1.610
IDC	.4	.4	.5
PHU	1971.	1862.	2254.

Table XII.1.--Continued
 EPIC output from example input data using annual printout

8/22/88 13: 7:48

EPIC PC 1758 VERSION

BELL, TX HOUSTON BLACK SOIL SERIES
 EXAM1528 EXAMPLE EPIC INPUT DATA
 876 MM 503 EI COTN GRSG WHET

1	TMX	25.80	TMN	13.39	RAD	15.56	RAIN	876.63	SNOW	3.53	RHUM	.67	WVL	5.39	Q	88.07	SSF	2.37
	PRK	.00	EI	701.47	EP	369.61	PET	1982.68	EI	215.31	MUSL	3.83	C	.55	YW	.00	YON	17.09
	YNO3	2.65	PRKN	.00	SSFN	.55	MNN	137.94	IMN	16.97	DN	5.07	NFIX	.00	UNO3	147.99	HMN	74.52
	COTS YLD =	2.55	T/HA	BIOM =	8.21	T/HA	IRGA =	0. MM	CAM =	461. MM	MX RD =	2.00	M	.00	T/HA			
	COST =	126.96	\$/HA	RTRN =	2804.24	\$/HA	EK =	.28	WK =	193. MM	HU =	1859. MM	LIME =	0. MM				
	STRESS DAYS (BIOMASS)--		WATER =	32.2			N =	.0	P =	.0	TEMP =	9.4	AIR =	1.7				
2	TMX	25.41	TMN	12.98	RAD	16.05	RAIN	904.53	SNOW	5.23	RHUM	.65	WVL	5.38	Q	145.56	SSF	2.52
	PRK	67.28	EI	807.75	EP	552.14	PET	2096.68	EI	295.60	MUSL	5.88	C	.48	YW	.00	YON	16.21
	YNO3	2.10	PRKN	29.74	SSFN	.41	MNN	130.99	IMN	15.95	DN	6.69	NFIX	.00	UNO3	208.68	HMN	71.46
	GRSG YLD =	3.52	T/HA	BIOM =	8.35	T/HA	IRGA =	0. MM	CAM =	517. MM	MX RD =	2.00	M	.00	T/HA			
	COST =	135.24	\$/HA	RTRN =	318.34	\$/HA	EK =	.29	WK =	193. MM	HU =	1778. MM	LIME =	1. MM				
	STRESS DAYS (BIOMASS)--		WATER =	28.6			N =	35.0	P =	.0	TEMP =	7.5	AIR =	1.3				
	WHHT YLD =	.00	T/HA	BIOM =	.00	T/HA	IRGA =	0. MM	CAM =	233. MM	MX RD =	0. MM	LIME =	.00	T/HA			
	COST =	.00	\$/HA	RTRN =	.00	\$/HA	EK =	.29	WK =	193. MM	HU =	0. MM	LIME =	1. MM				
	STRESS DAYS (BIOMASS)--		WATER =	4.7			N =	28.0	P =	.0	TEMP =	16.7	AIR =	.0				
3	TMX	25.84	TMN	12.78	RAD	16.57	RAIN	871.95	SNOW	1.87	RHUM	.65	WVL	5.32	Q	184.00	SSF	1.84
	PRK	.00	EI	610.49	EP	430.25	PET	2095.87	EI	546.23	MUSL	6.09	C	.42	YW	.00	YON	20.92
	YNO3	2.94	PRKN	.00	SSFN	.28	MNN	146.85	IMN	34.31	DN	2.03	NFIX	.00	UNO3	32.77	HMN	64.32
	WHHT YLD =	2.75	T/HA	BIOM =	8.10	T/HA	IRGA =	0. MM	CAM =	445. MM	MX RD =	2.00	M	.00	T/HA			
	COST =	175.11	\$/HA	RTRN =	329.67	\$/HA	EK =	.29	WK =	193. MM	HU =	2202. MM	LIME =	2. MM				
	STRESS DAYS (BIOMASS)--		WATER =	4.9			N =	110.0	P =	.0	TEMP =	7.6	AIR =	.0				

Table XII.1.--Continued
 EPIC output from example input data using annual printout

8/22/88 13: 7:48

EPIC PC 1758 VERSION
 BELL TX HOUSTON BLACK SOIL SERIES
 EXAM1528 EXAMPLE EPIC INPUT DATA
 876 MM 503 E1 COTN GRSG WHET

FINAL SOIL DATA

	1	2	3	4	5	6	7	8	9	TOT
DEPTH(M)	.00	.09	.48	.71	.91	1.12	1.35	1.51	2.00	
POROSITY(M/M)	.526	.528	.547	.528	.509	.525	.509	.487	.502	.517
FC SW(M/M)	.447E	.447E	.447E	.444E	.447E	.443E	.423E	.419E	.404	.437
WP SW(M/M)	.327E	.327E	.410E	.323E	.333E	.325E	.304E	.305E	.281	.324
SW(M/M)	.417E	.409E	.490E	.444E	.447E	.443E	.366E	.307E	.284E	.390
SAT COND(MM/H)	1.31E	1.31E	.99E	1.26E	1.13E	1.23E	1.30E	1.12E	1.46	
SSF TIME(D)	967.E	967.E	1028.E	987.E	1083.E	1001.E	1006.E	1194.E	959	
BD 33KPA(T/M3)	1.21	1.19	1.20	1.25	1.30	1.26	1.30	1.36	1.32	
BDD OV DRY(T/M3)	1.51	1.50	1.45	1.50	1.55	1.50	1.55	1.61	1.59	
SAND(%)	7.3	7.3	5.4	4.9	3.8	6.0	6.4	5.7	6.6	
SILT(%)	35.7	35.7	3.9	37.1	36.8	35.1	38.2	40.2	41.9	
CLAY(%)	57.0	57.0	90.7	58.0	59.4	58.9	55.4	54.1	51.5	
ROCK(%)	.0	.0	.0	.0	.0	.0	.0	.0	.0	
PH	8.0	8.0	8.3	8.2	8.0	8.0	8.1	8.3	8.2	
SM BS(CMOL/KG)	8.0E	8.0E	8.3E	8.2E	8.0E	8.0E	8.1E	8.3E	8.2	
CEC(CMOL/KG)	8.0E	8.0E	8.3E	8.2E	8.0E	8.0E	8.1E	8.3E	8.2	
AL SAT(%)	.0E	.0E	.0E	.0E	.0E	.0E	.0E	.0E	.0	
CAC03(%)	28.0	28.0	30.0	30.0	29.0	29.0	35.0	35.0	40.0	335.
LAB P(G/T)	36	36	18	15	15	10	10	10	5	
P SORP RTO	.41E	.41E	.40E	.40E	.40E	.40E	.37E	.37E	.34	
MN P AC(G/T)	51.E	51.E	28.E	23.E	22.E	15.E	17.E	17.E	10	524.
MN P ST(G/T)	164.E	163.E	121.E	91.E	89.E	59.E	69.E	69.E	40	2054.
ORG P(G/T)	146.E	147.E	118.E	94.E	71.E	48.E	51.E	20.E	11	1543.
NO3(G/T)	3	2	6	10	7	6	2	0	0	101.
ORG N AC(G/T)	217	218	66	53	41	27	18	11	7	1165.
ORG N ST(G/T)	931	940	882	699	533	359	233	145	86	11182.
ORG C(%)	1.44	1.46	1.26	1.08	.83	.86	.46	.38	.28	
CROP RSD(T/HA)	.00	.03	.02	.01	.00	.00	.00	.00	.00	.09
RWT(T/HA)	.00	.00	.00	.00	.00	.00	.00	.00	.00	.00

SOIL WATER BALANCE = -.443935E-03

ERODED SOIL THICKNESS = 2.0 MM
 FINAL WATER CONTENT OF SNOW = .00 MM

N BALANCE = -.0028

P BALANCE = .0000

Table XII.1.--Continued
 EPIC output from example input data using annual printout

8/22/88 13: 7:48

EPIC PC 1758 VERSION
 BELL TX HOUSTON BLACK SOIL SERIES
 EXAM1528 EXAMPLE EPIC INPUT DATA
 876 MM 503 EI COTN GRSG WHET

SUMMARY TABLE

-----PEAK FLOW RATE STATS(MM/H) MEAN = 3.85 ST DV = 7.876 GEN EFF = .251
 MAX = 64.23

-----AVE MO VALUES

	JAN	FEB	MAR	APR	MAY	JUN	JUL	AUG	SEP	OCT	NOV	DEC	YR	C
USLE	.35	.67	.71	.17	.42	.47	.20	.30	.63	1.04	.29	.58	.46	USLE
YH	.04	.55	.85	.29	.71	3.90	.12	.22	.16	1.04	.30	.23	8.40	YH
RAIN	37.6	71.0	67.5	105.3	96.6	138.9	55.1	54.0	29.0	61.3	84.6	83.5	884.4	RAIN
DAYP	7.00	7.67	7.33	9.67	5.33	7.33	5.67	6.33	5.00	4.00	8.00	7.67	81.00	DAYP
PRK	0	0	0	0	0	0	0	0	0	0	0	0	22.4	PRK
Q	2.7	12.3	9.7	21.1	14.0	33.5	2.1	.6	.2	8.2	11.6	14.2	139.2	Q
EI	2	16	23	33	32	160	12	14	5	28	20	8	352	EI
DAYQ	1.00	2.67	2.33	4.67	2.67	3.33	1.33	1.33	3.33	2.00	4.33	4.00	30.00	DAYQ
SW	.05	.06	.06	.07	.07	.06	.03	.02	.02	.03	.04	.05	.05	SW
QIN	.00	.00	.00	.00	.00	.00	.00	.00	.00	.00	.00	.00	.00	QIN
ET	40	37	50	72	68	147	97	43	31	31	54	38	707	ET
PET	99	111	172	194	124	262	267	261	214	161	111	82	2058	PET
TMX	17.16	19.00	18.86	24.69	30.35	33.64	35.06	35.99	31.44	27.65	21.16	13.59	25.68	TMX
TMN	4.92	5.15	6.58	11.55	17.68	20.90	22.43	23.10	19.21	15.65	8.57	2.85	13.05	TMN
RAD	11	13	17	20	6	24	24	22	19	15	11	10	16	RAD
HRLT	10.12	10.64	11.47	12.48	13.39	14.05	14.14	13.63	12.74	11.76	10.82	10.20		HRLT

-----AVE ANNUAL VALUES

3	TMX	25.68	TMN	13.05	RAD	16.06	RAIN	884.37	SNOW	3.54	RHUM	.66	WVL	C	SSSF	2.24
	PRK	22.43	ET	706.57	EP	450.66	PET	2058.41	EI	352.38	MUSL	5.27	WVL	C	YON	18.07
	YNO3	2.56	PRKN	9.91	SSFN	.41	MNN	138.59	IMN	22.41	USLE	8.40	NFIX	2.60	HMN	70.10
	IRGA	.00	FN	13.20	FP	25.05	CN	82.86	AOF	7.05	UNO3	129.81	WVL	7.07	LIME	.00
	COST	145.77	RTRN	1150.75												

-----AVE ANNUAL CROP YLD DATA

CROP	YLD (T/HA)	BIOM (T/HA)	RAD (MJ/M2)	HU (C)	RD (M)	WATER	N	P	TEMP	AIR	BD	ALSAI	ROOT	GROWTH	TEMP
COTS	2.55	8.21	2388.	1859.	2.00	32.2	0	0	9.4	1.7	0	0	0	0	3.1
GRSG	3.32	8.35	2410.	1778.	2.00	28.6	35.0	0	7.5	1.3	0	0	0	0	5.0
WHHT	2.75	8.10	3049.	2202.	2.00	9.6	138.0	0	24.3	0	0	0	0	0	4.6

Table XII.3.

EPIC output from example input data using monthly printout

8/22/88 13:21: 5

EPIC PC 1758 VERSION

BELL, TX HOUSTON BLACK SOIL SERIES
 EXAM1528 EXAMPLE EPIC INPUT DATA
 876 MM 503 EI COTN GRSG WHET

	JAN	FEB	MAR	APR	MAY	JUN	JUL	AUG	SEP	OCT	NOV	DEC	YR	TMX
TMX	14.68	22.67	18.69	23.96	30.10	32.24	34.91	35.10	31.83	27.07	22.38	16.00	25.80	TMX
TMN	3.94	6.95	7.79	10.72	17.40	19.59	22.59	23.08	20.00	12.58	11.05	6.98	13.39	TMN
RAD	10.94	13.19	15.46	19.32	5.84	25.40	23.01	20.32	18.00	15.40	10.33	9.49	15.56	RAD
RAIN	25.13	62.28	72.20	53.81	69.14	76.32	94.18	78.15	28.48	83.02	89.90	144.05	876.63	RAIN
SNOW	.00	.00	.00	.00	.00	.00	.00	.00	.00	.00	.00	3.53	3.53	SNOW
RHUM	6.31	7.71	6.42	6.91	5.92	4.54	4.47	4.90	4.62	3.92	5.06	5.10	5.39	RHUM
WVL	.02	3.70	5.86	2.47	13.18	2.72	6.20	.84	4.60	8.42	11.95	32.72	88.07	WVL
Q	.00	.12	.18	.13	.27	.26	.19	.11	.03	.17	.27	.61	2.37	Q
SSF	.00	.00	.00	.00	.00	.00	.00	.00	.00	.00	.00	.00	.00	SSF
PRK	19.54	35.59	44.56	34.76	36.11	141.99	178.84	73.02	30.71	31.94	39.16	35.25	701.47	PRK
ET	.00	.00	.00	.00	.00	.00	.00	.00	.00	.00	.00	.00	.00	ET
EP	100.48	126.96	145.83	187.08	138.57	251.92	248.85	231.21	208.81	156.39	107.37	79.21	369.61	EP
PET	.00	9.58	8.43	9.11	14.78	30.34	35.72	20.29	3.15	52.46	15.22	16.63	1982.68	PET
EI	.00	.21	.32	.14	.66	.12	.09	.01	.00	.75	.55	1.28	215.31	EI
MUSL	.00	.77	.78	.78	.77	.40	.20	.20	.21	.70	.75	1.28	3.83	MUSL
C	.00	.00	.00	.00	.00	.00	.00	.00	.00	.00	.00	.00	.00	C
YV	.00	1.36	.71	.97	1.07	2.50	1.78	1.03	.17	.00	.00	.00	.00	YV
YON	.00	.08	.15	.04	.16	.02	.06	.00	.00	4.62	1.61	1.27	17.09	YON
YNO3	.00	.00	.00	.00	.00	.00	.00	.00	.00	1.48	3.31	.34	2.65	YNO3
PRKN	.00	.00	.00	.00	.00	.00	.00	.00	.00	.00	.00	.00	.00	PRKN
SSFN	.00	.02	.04	.03	.08	.06	.00	.00	.01	.09	.08	.13	.55	SSFN
MNN	2.77	3.85	4.01	5.41	8.31	8.69	9.22	9.13	64.34	13.03	5.55	3.62	137.94	MNN
IMN	.19	.06	.06	.04	.02	.00	.00	.00	15.98	.48	1.24	.30	16.97	IMN
DN	.00	.23	.22	.16	.96	.43	.05	.00	.00	1.17	1.07	.02	5.07	DN
NFIX	.00	.00	.00	.00	.00	.00	.00	.00	.00	.00	.00	.00	.00	NFIX
UNO3	.00	.00	.00	1.52	1.29	68.64	62.74	13.80	.00	.00	.00	.00	.00	UNO3
HMN	2.58	3.71	3.91	5.34	8.26	8.69	9.21	9.11	8.58	7.19	4.63	3.31	147.99	HMN
SW	.05	.06	.07	.08	.09	.05	.00	.00	.00	.03	.05	.09	74.52	SW
WTBL	75.00	75.00	75.00	75.00	75.00	75.00	75.00	75.00	75.00	75.00	75.00	75.00	75.00	WTBL
TNO3	130.80	134.71	138.53	142.59	148.94	89.08	36.21	32.15	80.73	91.20	95.77	99.74	99.74	TNO3
HU	.00	.00	.00	28.06	392.28	809.86	1329.18	1859.00	.00	.00	.00	.00	.00	HU
LAI	.00	.00	.00	.05	.18	3.59	4.76	8.88	.00	.00	.00	.00	.00	LAI
RD	.00	.00	.00	.06	.19	2.00	2.00	2.00	.00	.00	.00	.00	.00	RD
RW	.00	.00	.00	.00	.03	1.10	1.92	1.75	.00	.00	.00	.00	.00	RW
BIOM	.00	.00	.00	.02	.10	3.46	7.19	8.21	.00	.00	.00	.00	.00	BIOM
RSD	.00	.00	.00	.00	.00	.00	.00	.00	.12	.04	.03	.01	.01	RSD
STD	.00	.00	.00	.00	.00	.00	.00	.00	.20	.00	.00	.00	.00	STD
STRS	.00	.00	.00	.00	.00	.00	.00	.00	.00	.00	.00	.00	.00	STRS

COSTS YLD = 2.55 T/HA BIOM = 8.21 T/HA IRGA = 0.28 MM CAW = 461. MM MX RD = 2.00 M LIME = .00 T/HA
 COST = 126.96 \$/HA RIRN = 2804.24 \$/HA EK = .28 WK = 193. MX HU = 1859. THK = 9.4 AIR = 1.7
 STRESS DAYS (BIOMASS) -- WATER = 32.2 N = .0 P = .0



